

Promat



Compartmentation

Passive Fire Protection

Access Panels

Technical manual

Hong Kong version

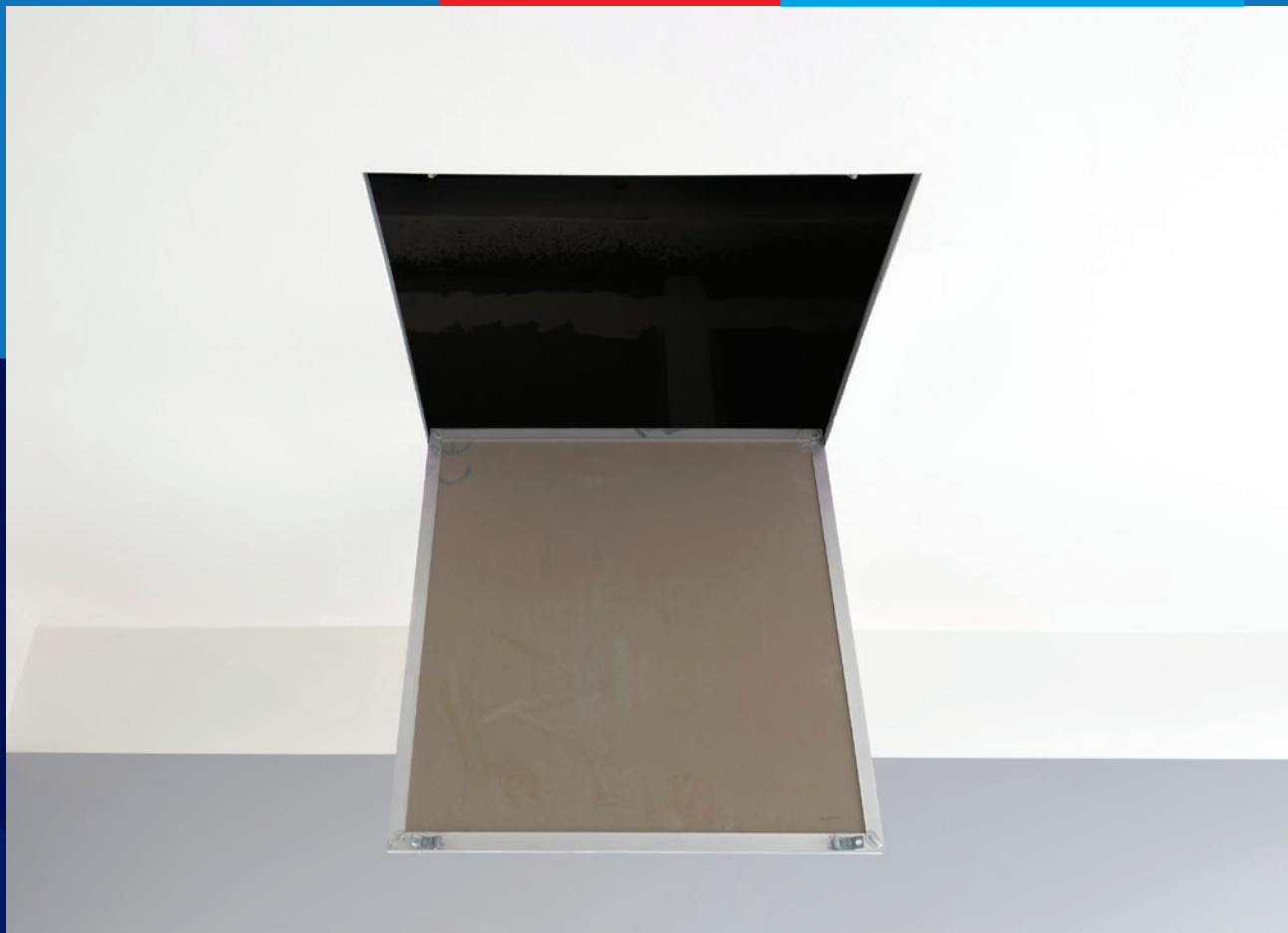

www.promat.com

2024-06

etex inspiring ways
of living



Contents

Promat Fire Resistant Access Panels	4
Installation guide	5
Fire test standards	6
Access panels system overview	7
PROMATECT®-H – 1-hour fire rated access panel (single access door)	10
PROMATECT®-H – 1-hour fire rated access panel (multi access door)	11
PROMATECT®-H – 1-hour fire rated access panel	12
PROMATECT®-H – 2-hour fire rated access door (Integrity only)	13
PROMINA®-60 – 1-hour fire rated access panel	14
PROMATECT®-S – 2-hour and 4-hour fire rated access panel (Integrity only)	15
PROMATECT®-H – 1-hour fire rated access panel	16
PROMATECT®-H – 2-hour fire rated access panel	17
PROMATECT®-H – 2-hour and 4-hour fire rated access panel (Integrity only)	18
PROMATECT®-H – 2-hour fire rated access panel (Integrity only)	19
PROMATECT®-S – 2-hour and 4-hour fire rated access panel (Integrity only)	20
PROMINA®-60 – 1-hour fire rated access panel	21
PROMATECT®-L500 and PROMATECT®-H – 2-hour fire rated access panel	22
PROMATECT®-H – 2-hour and 4-hour fire rated access panel (Integrity only)	23
PROMATECT®-H – 2-hour fire rated access panel	24
PROMATECT®-H – 2-hour and 4-hour fire rated access panel (Integrity only)	25

Promat



Promat Fire Resistant Access Panels

Permits openable access to spaces in fire compartments without compromising on fire performance.

The Promat Fire Resistant Access Panels comes as a complete unit, a panel of plain surface finish on both faces, set into a galvanised steel rebated frame, surrounded with perimeter bead. Available either hinged with a flush locking mechanism or screw fixed, Promat Fire Resistant Access Panels are designed so as to blend well aesthetically with the fire resistant element to give a elegant look, providing access and ensuring the fire resistance performance of the compartment element remains intact.

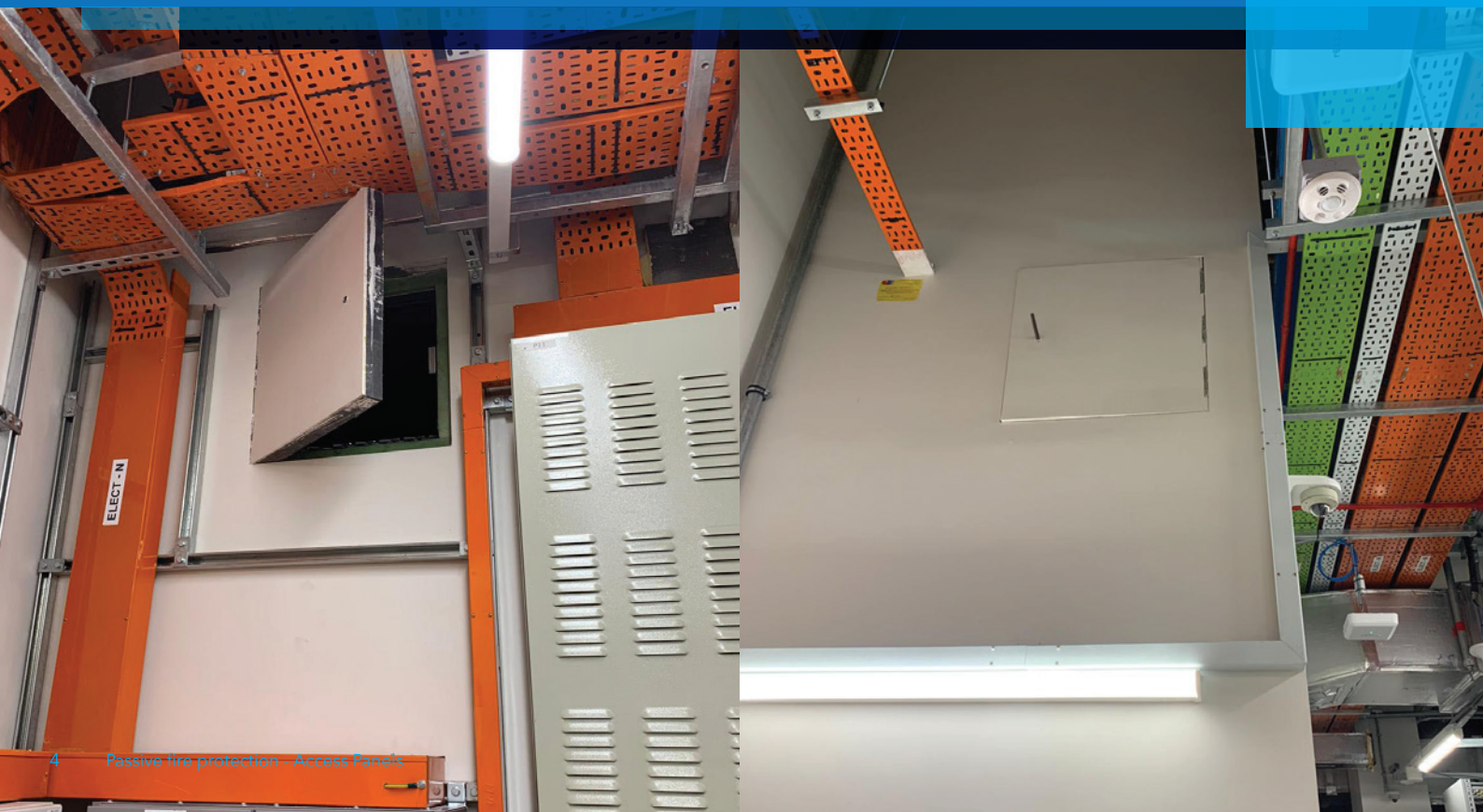

Installation guide

The Basic supporting fire resistant element

Promat Fire Resistant Access Panels are fire tested to the most onerous conditions. The Promat Fire Resistant Access Panel unit is set within a dry constructed element including PROMATECT® fire resistant ceiling and PROMATECT® E&M enclosure construction. It is also suited if set in a masonry construction or other dry construction such as fire resistant plasterboard ceilings provided the structural framework of the ceiling is appropriately designed to support the weight and fixing details of the Promat Access Panel unit.

The opening prepared to receive the Promat Fire Resistant Access Panel unit shall be adequately framed and structured so as to be capable to support the Promat Fire Resistant Access Panels.

Where openings are made post construction to receive the Access Panel unit, care shall be taken to ensure the perimeter of the opening is made structurally sound, reinforced and duly supported.

Appropriate fire resistance

The Promat Fire Resistant Access Panel shall have equal or higher fire resistance performance than the fire resistant element.

Installation

1. The opening formed within the fire resistant element shall be duly structured & reinforced such as to be able to hold the weight of the Promat Access Panel.
2. Preferably the dimensions of the opening shall provide a tight fit for the Promat Access Panel unit, and/or a tolerance gap of not more than 5mm.
3. With the panel opened secure the galvanised steel frame from the inside of the frame to the perimeter steel structure of the opening, using minimum M8 self-tapping screws through preformed screw holes in the galvanised steel frame. Minimum 2 screws on each of the 4 sides of the frame.
4. Seal the perimeter gaps with a bead of PROMASEAL®-A sealant.
5. The surface of the Promat Fire Resistant Access Panel can be left plain or finished with any desired architectural finish provided it complies with the surface spread of flame requirements of the local regulations.

Fire test standards

Fire test standards tests define fire performance in terms of

A material's REACTION to Fire

Such tests define the specimen's property in terms of its level of non-combustible behaviour, its surface spread of flame, its smoke behaviours.

A full construction's RESISTANCE to fire

Unlike the property of a singular material specimen, fire resistance is a measure of the performance of a complete system construction when exposed to the standard heating conditions of either one of the international time temperature fire curves. The criteria of assessment are:

Load bearing capacity - The ability of a loadbearing specimen construction to support the test load without exceeding specific criteria with respect to its rate and extent of deformation.

Integrity - The ability of a fire separating element to contain a fire in terms of no collapse, no development of fissures, cracks or holes and no sustaining flames on the unexposed face of the specimen.

Insulation - The ability of a fire separating element to restrict thermal heat transfer to the unexposed face to below specific limits; ie 140°C mean rise in temperature, 180°C maximum rise in temperature on the unexposed face.

Below are some widely adopted fire testing standards:

Reaction to fire		Resistance to fire	
BS 476: Part 4	EN 1182	BS 476: Part 20	EN 1363 series
BS 476: Part 5	EN 1716&	BS 476: Part 21	EN 1364 series
BS 476: Part 6	EN 13823	BS 476: Part 22	EN 1365 series
BS 476: Part 7	EN 11925	BS 476: Part 24	EN 1366 series

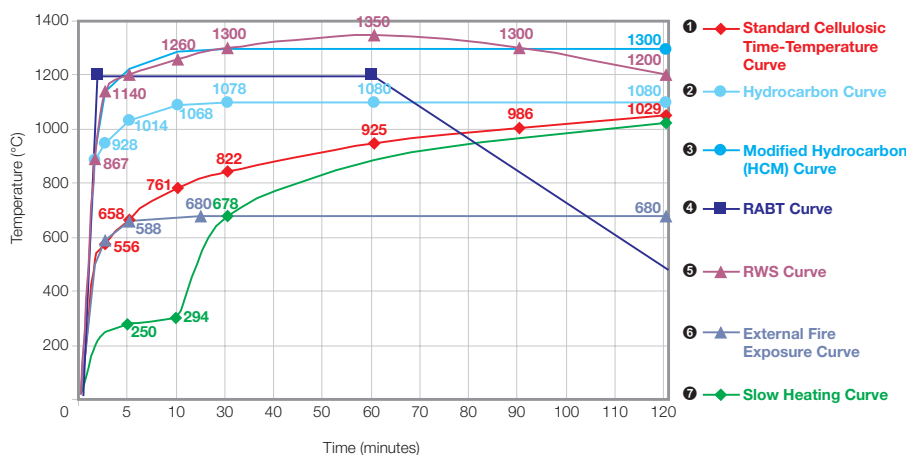





Fire curves

Vertical access panels - Hinged type

Access panels type	Model number	Fire resistance performance	Test standard	Test assessment report no.	Page no.
 <p>PROMATECT®-H – 1-hour fire rated access panel (single access door)</p>	PH.16.60	-/60/60	BS 476: Part 22: 1987	RED R22H05-1A issue 1	10
 <p>PROMATECT®-H – 1-hour fire rated access panel (multi access door)</p>	PH.16.60	-/60/60	BS 476: Part 22: 1987	RED R22H05-1A issue 1	11
 <p>PROMATECT®-H – 1-hour fire rated access panel</p>	PH.16.60	-/60/60	BS 476: Part 22: 1987	RED R23E19-1A	12
 <p>PROMATECT®-H – 2-hour fire rated access door (Integrity only)</p>	PH.16.12.E	-/120/-	BS 476: Part 22: 1987	RED R23B16-1A	13
 <p>PROMIMA® 60 – 1-hour fire rated access panel</p>	PMF.16.60	-/60/60	BS 476: Part 22: 1987	WF 430406 issue 3	14
 <p>PROMATECT®-S – 2-hour and 4-hour fire rated access panel</p>	PS.16.12.E	-/120/-	BS 476: Part 22: 1987	RED R23E20-1A	15
	PS.16.24.E	-/240/-			

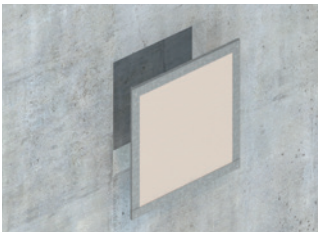
Vertical access panels - Fixed type

Access panels type	Model number	Fire resistance performance	Test standard	Test assessment report no.	Page no.
 <p>PROMATECT®-H – 1-hour fire rated access panel</p>	PH.18.60	-/60/60	BS 476: Part 22: 1987	BRE P104858-1088 issue 1	16
 <p>PROMATECT®-H – 2-hour fire rated access panel</p>	PH.18.12	-/120/120	BS 476: Part 22: 1987	BRE P104858-1088 issue 1	17
 <p>PROMATECT®-H – 2-hour and 4-hour fire rated access panel (Integrity only)</p>	PH.18.12.E	-/120/-	BS 476: Part 22: 1987	WF 144342 issue 2	18
	PH.18.24.E	-/240/-			
 <p>PROMATECT®-H – 2-hour fire rated access panel (Integrity only)</p>	PH.18.12.E	-/120/-	BS 476: Part 22: 1987	BRE cc 83300 review 7 issue 1	19
 <p>PROMATECT®-S – 2-hour and 4-hour fire rated access panel (Integrity only)</p>	PS.18.12.E	-/120/-	BS 476: Part 22: 1987	RED R23L24-1A	20
	PS.18.24.E	-/240/-			

Horizontal access panels - Hinged type

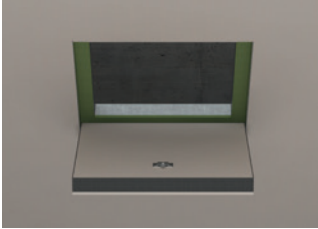
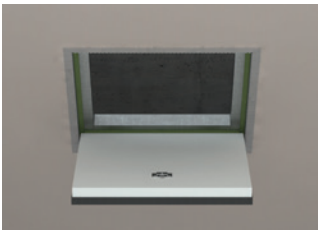
Access panels type	Model number	Fire resistance performance	Test standard	Test assessment report no.	Page no.
 <p>PROMIMA® 60 – 1-hour fire rated access panel</p>	PMF.15.60	-/60/60	BS 476: Part 22: 1987	WF 430406 issue 3	21
 <p>PROMATECT®-L500 and PROMATECT®-H – 2-hour fire rated access panel</p>	PE+PH.15.12	-/120/120	BS 476: Part 20 and 22: 1987	FSRG 2018/033	22

Horizontal access panels - Fixed type

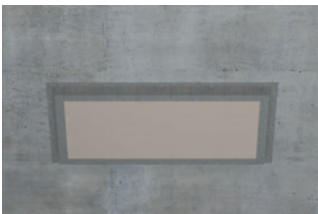
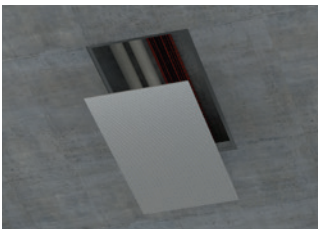
Access panels type	Model number	Fire resistance performance	Test standard	Test assessment report no.	Page no.
 <p>PROMATECT®-H – 2-hour and 4-hour fire rated access panel (Integrity only)</p>	PH.17.12.E	-/120/-	BS 476: Part 22: 1987	WF 144342 issue 2	23
	PH.17.24.E	-/240/-			
 <p>PROMATECT®-H – 2-hour fire rated access panel</p>	PH.15.12	-/120/120	BS 476: Part 22: 1987	RED R23E19-1A	24
 <p>PROMATECT®-S – 2-hour and 4-hour fire rated access panel (Integrity only)</p>	PS.15.12.E	-/120/-	BS 476: Part 22: 1987	RED R23L24-1A	25
	PS.15.24.E	-/240/-			

PROMATECT®-H – 1-hour fire rated access panel (single access door)

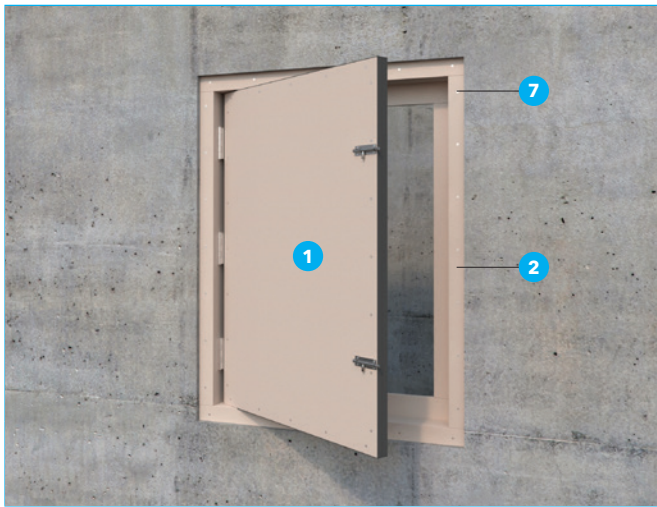

Fire Resistance	FRR	-/60/60	Model number: PH.16.60
	Standard	BS 476: Part 20 and 22: 1987	
	Approval	RED R22H05-1A issue 1	
Construction	Orientation	Vertical	
	Nature of connection	Masonry wall	
	Type	Hinged	

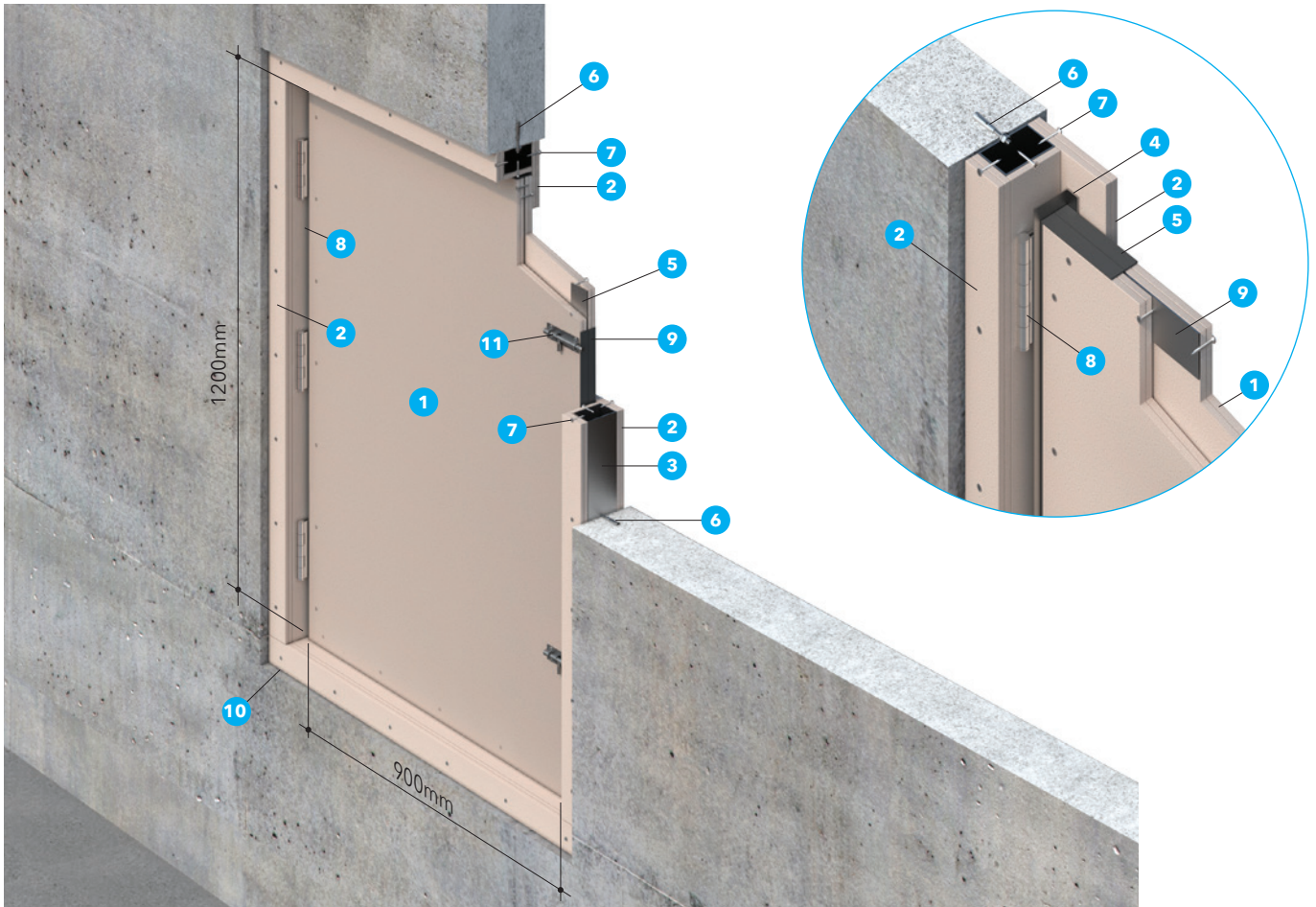

1. PROMATECT®-H board 3 x 12mm thick or 4 x 9mm thick.
2. PROMATECT®-H fillet 3 x 12mm thick or 4 x 9mm thick.
3. 75mm x 50mm x 2mm thick steel hollow section.
4. 20mm x 50mm x 2mm thick steel angle.
5. 50 x 2mm thick steel flat bar.
6. M8 steel anchor bolts at nominal 500mm centres.
7. Min. 35mm long self tapping screws at nominal 200mm centres.
8. Steel hinge.
9. 20mm x 2mm thick PROMASEAL® LFCSK intumescent strip.
10. All perimeter gaps seal with PROMASEAL® Intumescent Acrylic Sealant.
11. Latch lock.

PROMATECT®-H – 1-hour fire rated access panel (multi access door)

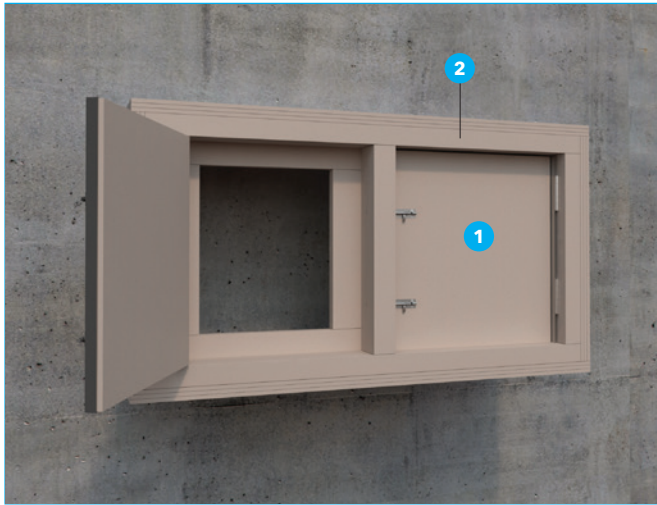

Fire Resistance	FRR	-/60/60	Model number: PH.16.60
	Standard	BS 476: Part 20 and 22: 1987	
	Approval	RED R22H05-1A issue 1	
Construction	Orientation	Vertical	
	Nature of connection	Masonry wall	
	Type	Hinged	

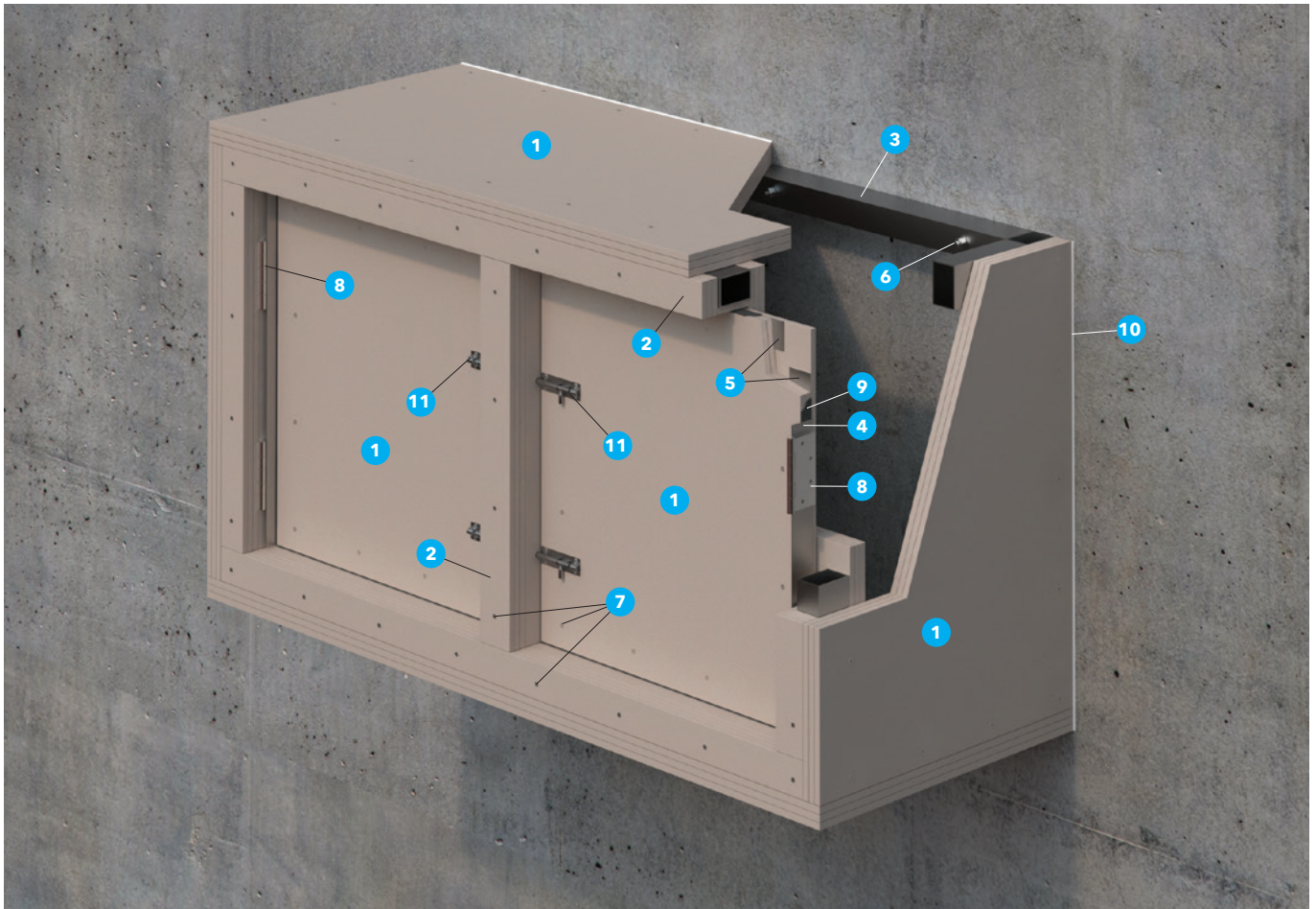

1. PROMATECT®-H board 3 x 12mm thick or 4 x 9mm thick.
2. PROMATECT®-H fillet 3 x 12mm thick or 4 x 9mm thick.
3. 75mm x 50mm x 2mm thick steel hollow section.
4. 20mm x 50mm x 2mm thick steel angle.
5. 50 x 2mm thick steel flat bar.
6. M8 steel anchor bolts at nominal 500mm centres.
7. Min. 35mm long self tapping screws at nominal 200mm centres.
8. Steel hinge.
9. 20mm x 2mm thick PROMASEAL® LFCSK intumescent strip.
10. All perimeter gaps seal with PROMASEAL® Intumescent Acrylic Sealant.
11. Latch lock.

PROMATECT®-H – 1-hour fire rated access panel

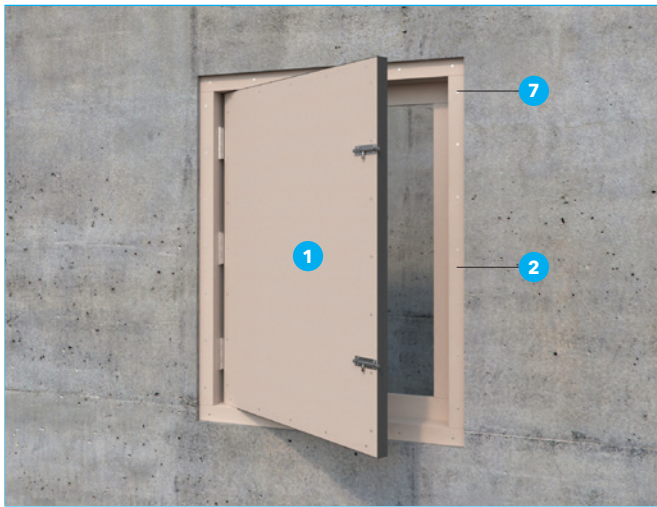

Fire Resistance	FRR	-/60/60	Model number: PH.16.60
	Standard	BS 476: Part 20 and 22: 1987	
	Approval	RED R16A08-1A	
Construction	Orientation	Vertical	
	Nature of connection	Masonry wall	
	Type	Hinged	

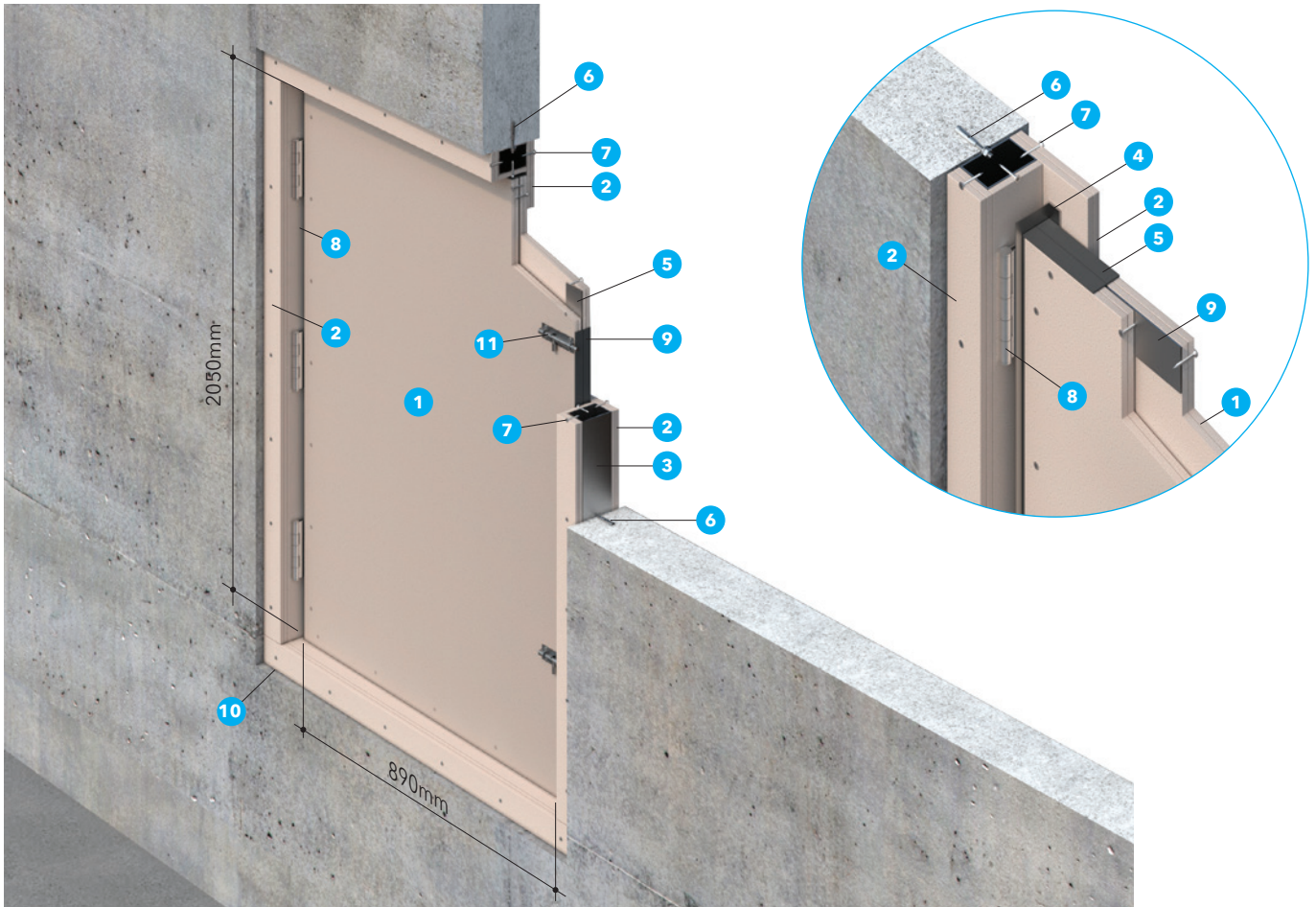

1. PROMATECT®-H board 4 x 9mm thick.
2. PROMATECT®-H fillet 2 x 9mm thick.
3. 2 nos. steel channel forming back-to-back 75 x 50 x 2mm thick.
4. 20mm x 50mm x 2mm thick steel angle.
5. 50 x 2mm thick steel flat bar.
6. M8 steel anchor bolts at nominal 500mm centres.
7. Min. 35mm long M4 self tapping screws at nominal 200mm centres.
8. Steel hinge.
9. 20mm x 2mm thick intumescent expansion strip.
10. All perimeter gaps seal with PROMASEAL® Intumescent Acrylic Sealant.
11. Latch lock.

PROMATECT®-H – 2-hour fire rated access door (Integrity only)



Fire Resistance	FRR	-/120/-	Model number: PH.16.12.E
	Standard	BS 476: Part 22: 1987	
	Approval	RED R23B16-1A	
Construction	Orientation	Vertical	
	Nature of connection	Promat fire rated partition	
	Type	Hinged	

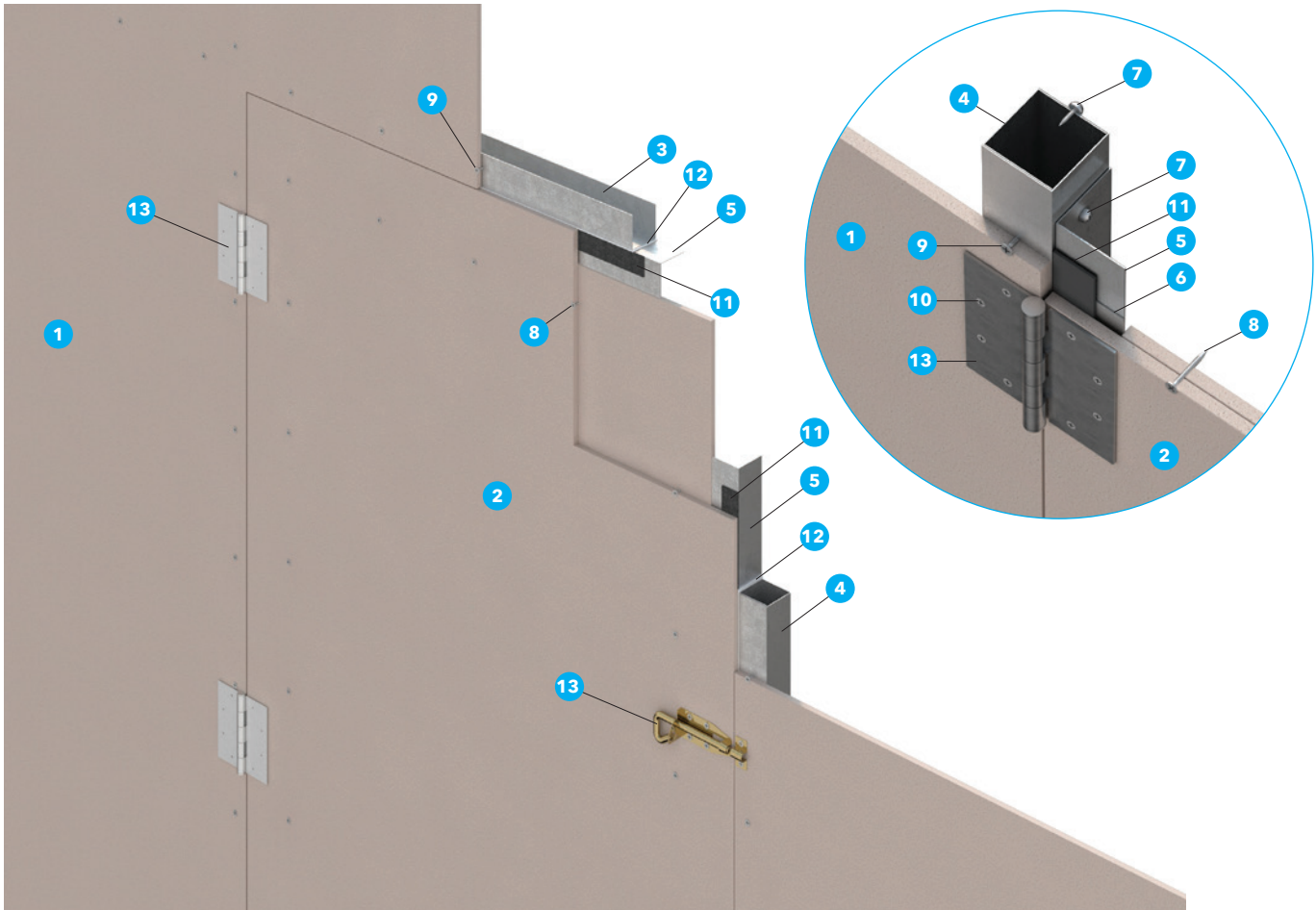

1. Promat fire rated partition.
2. Access door form by PROMATECT®-H board 2 x 9mm thick.
3. Steel stud.
4. Steel stud face to face.
5. Steel L-angle 50 x 50 x 0.8mm.
6. Steel plate 50 x 100 x 0.8mm thick. (where is it?)
7. Buttonhead screws 8g x 12mm.
8. Stitching screw Ø 5.5 x 40mm.
9. Drywall screws No. 6 x 32mm.
10. Drywall screws No. 8 x 25mm.
11. PROMASEAL® LFCSK intumescent strip 30 x 2mm thick.
12. PROMASEAL® Intumescent Acrylic Sealant.
13. Steel hinge 70 x 100 x 2mm thick.
14. Steel door latch.

PROMINA®-60 – 1-hour fire rated access panel

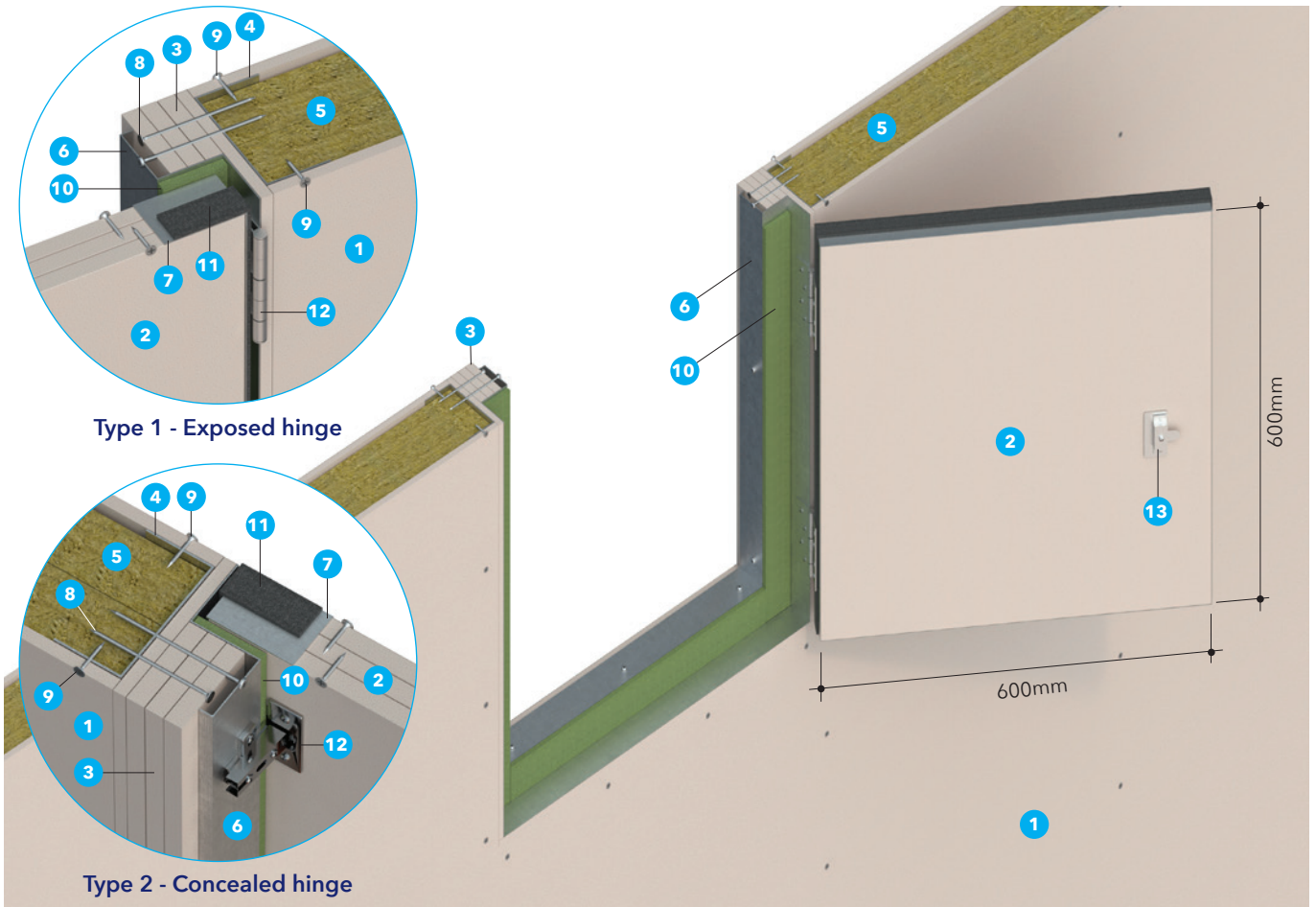
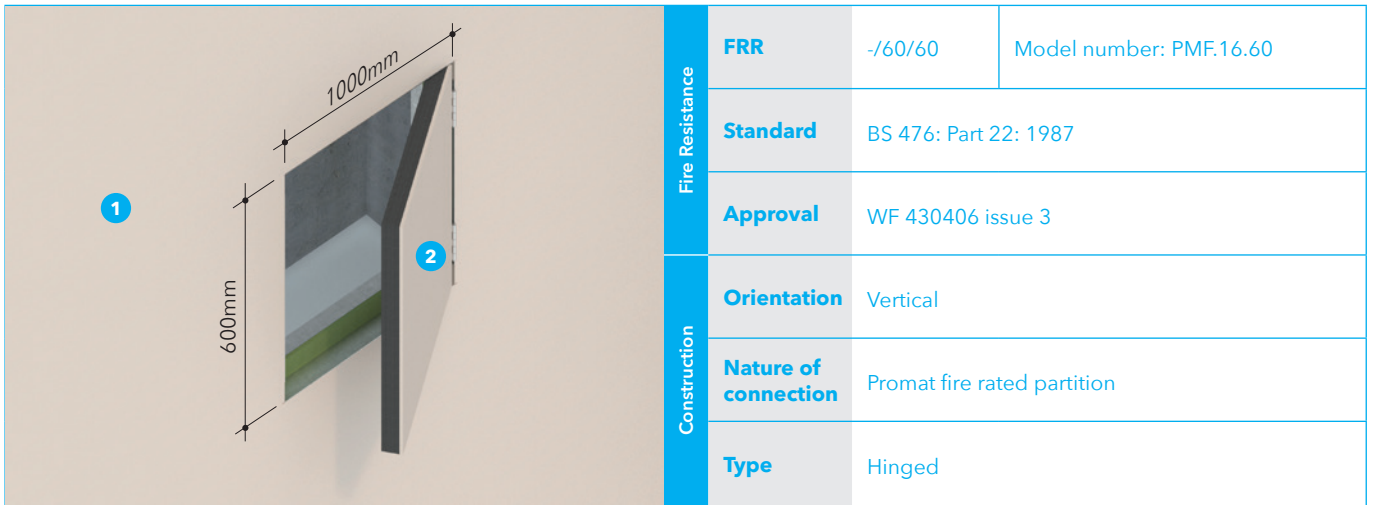

1. Promat fire rated partition.
2. Access door 36mm thick form by PROMINA®-60 board 3 X 12mm thick.
3. PROMATECT®-H or PROMINA®-60 cover strips 12mm thick.
4. Steel channel 92 x 36 x 1.15mm thick.
5. Mineral wool min. 50mm thick x 60kg/m³.
6. Access panel frame 1.0mm thick
7. Door frame angle.
8. Drywall self-tapping screws No. 8 x 127mm.
9. Drywall self-tapping screws No. 8 x 38mm.
10. PROMASEAL® IBST™ 10mm thick x 50mm wide.
11. PROMASEAL® Intumescent strip 3mm thick x 25mm wide.
12. Hinges.
13. Budget lock.

PROMATECT®-S – 2-hour and 4-hour fire rated access panel (Integrity only)

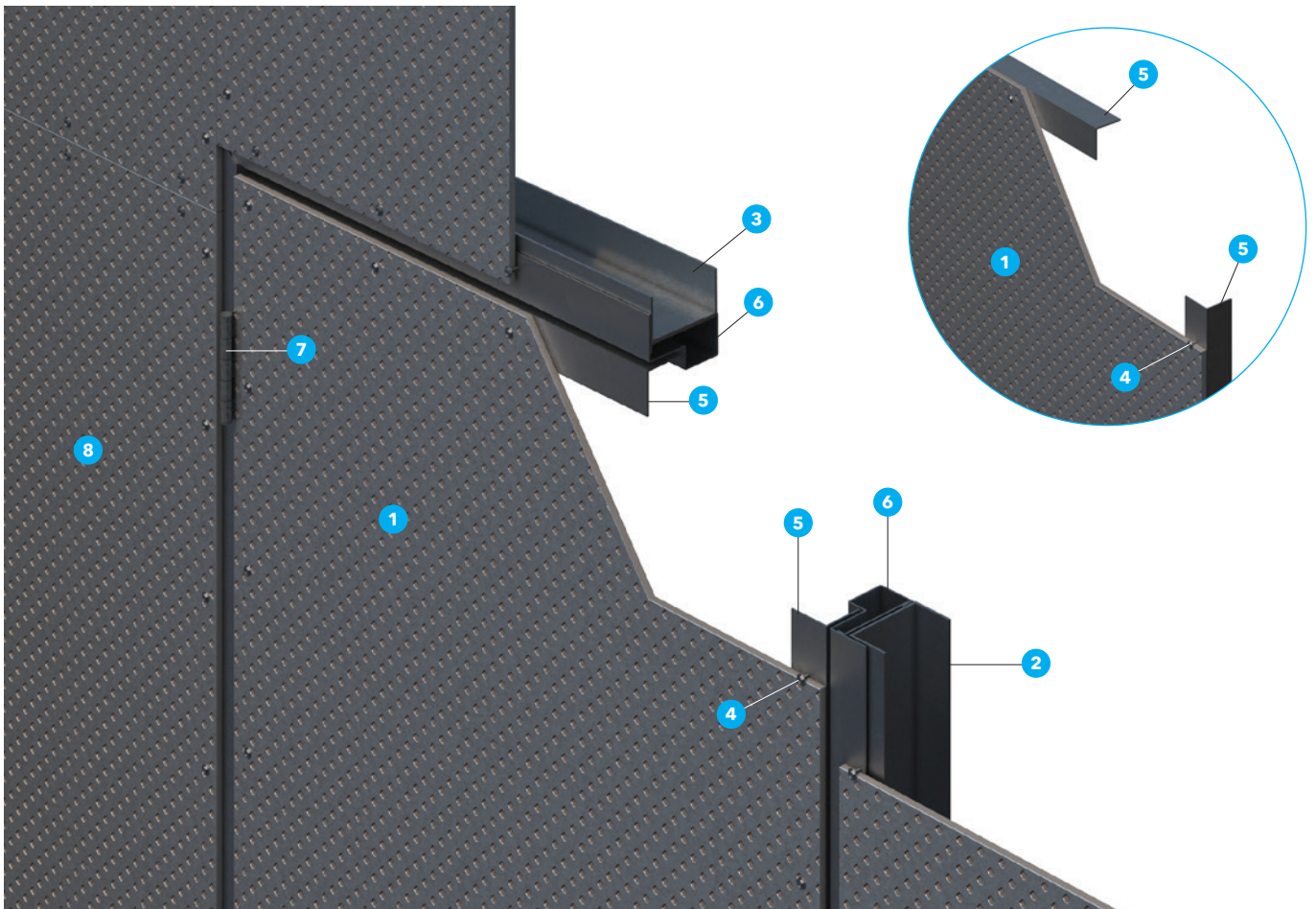
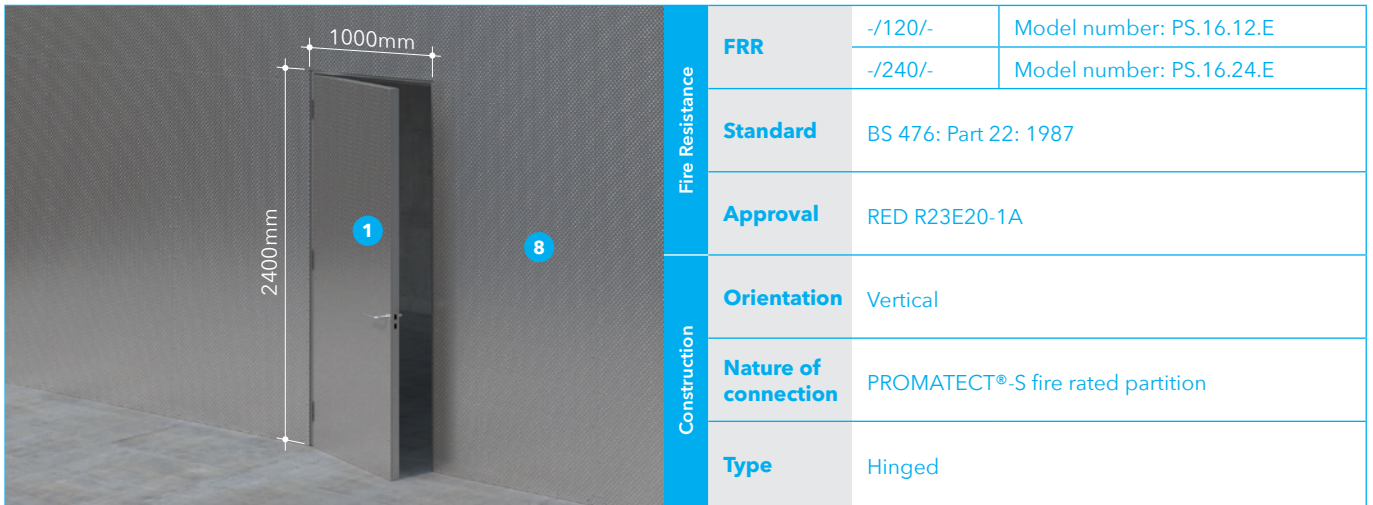

1. PROMATECT®-S board 6mm thick.
2. Vertical steel stud 100 x 50 x 3mm thick at nominal 1200mm centres.
3. Steel top and bottom track 100 x 50 x 3mm thick.
4. Min. M5.5 x 38mm long self-drilling teks screws at nominal 200mm centres.
5. L- angle door frame.
6. Door jamb.
7. Door hinge.
8. PROMATECT®-S fire rated partition.

PROMATECT®-H – 1-hour fire rated access panel

	Fire Resistance	FRR	-/60/60	Model number: PH.18.60
		Standard	BS 476: Part 22: 1987	
		Approval	BRE P104858-1088 issue 1	
	Construction	Orientation	Vertical	
		Nature of connection	Masonry wall	
		Type	Fixed	

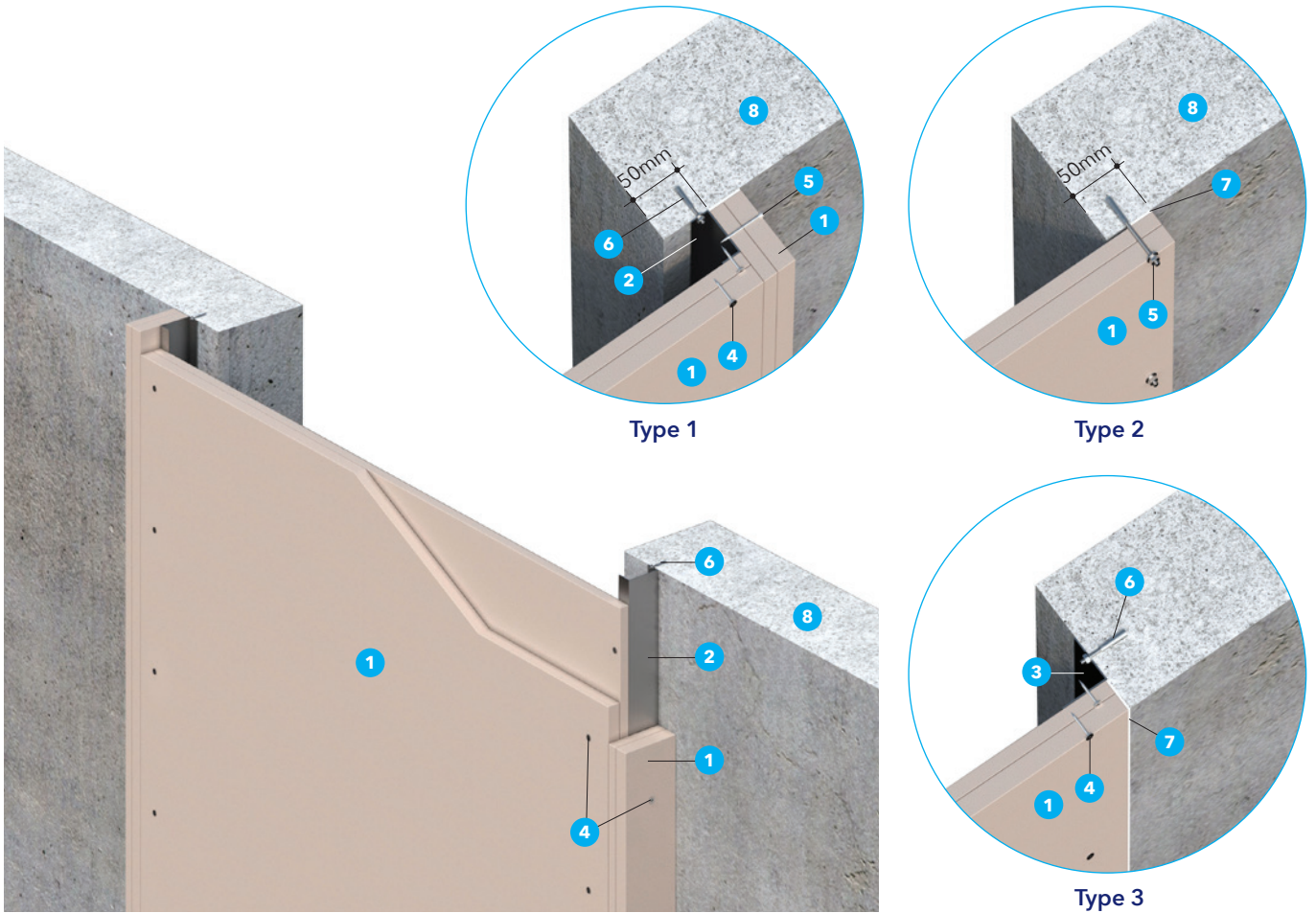

1. PROMATECT®-H board 20mm + 15mm thick.
2. Perimeter channel 50 x 20 x 1mm thick.
3. Perimeter L-angle 50 x 50 x 1mm thick.
4. M4 self-tapping screws at nominal 200mm centres.
5. M6 Expansion bolts at nominal 200mm centres.
6. M6 Expansion bolts at nominal 500mm centres.
7. Seal small gaps around panel edge with PROMASEAL® Intumescent Acrylic Sealant.
8. Masonry wall.

PROMATECT®-H – 2-hour fire rated access panel

	Fire Resistance	FRR	-/120/120	Model number: PH.18.12
		Standard	BS 476: Part 22: 1987	
		Approval	BRE P104858-1088 issue 1	
	Construction	Orientation	Vertical	
		Nature of connection	Masonry wall	
		Type	Fixed	

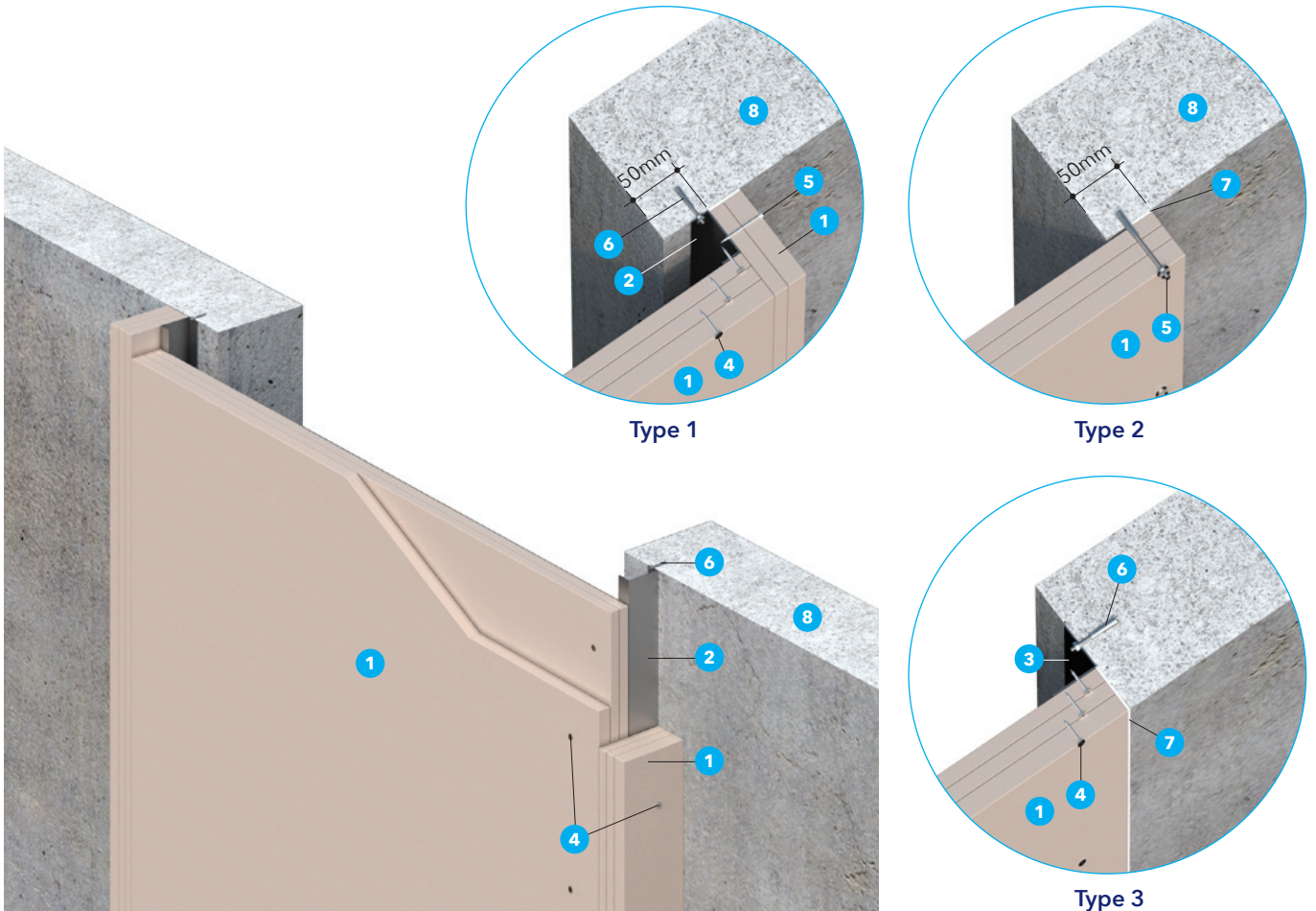

1. PROMATECT®-H board 20mm + 15mm + 15mm thick.
2. Perimeter channel 50 x 20 x 1mm thick.
3. Perimeter L-angle 50 x 50 x 1mm thick.
4. M4 self-tapping screws at nominal 200mm centres.
5. M6 Expansion bolts at nominal 200mm centres.
6. M6 Expansion bolts at nominal 500mm centres.
7. Seal small gaps around panel edge with PROMASEAL® Intumescent Acrylic Sealant.
8. Masonry wall.

PROMATECT®-H – 2-hour and 4-hour fire rated access panel (Integrity only)

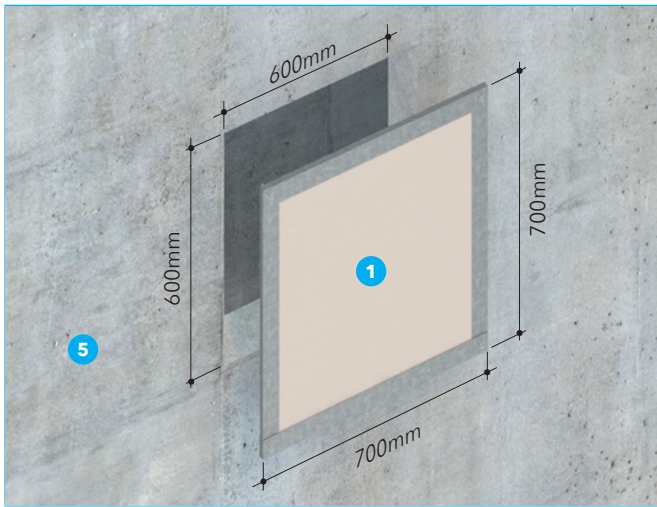

Fire Resistance	FRR	-/120/-	Model number: PH.18.12.E
		-/240/-	Model number: PH.18.24.E
	Standard	BS 476: Part 22: 1987	
	Approval	WF 144342 issue 2	
Construction	Orientation	Vertical	
	Nature of connection	Masonry wall	
	Type	Fixed	

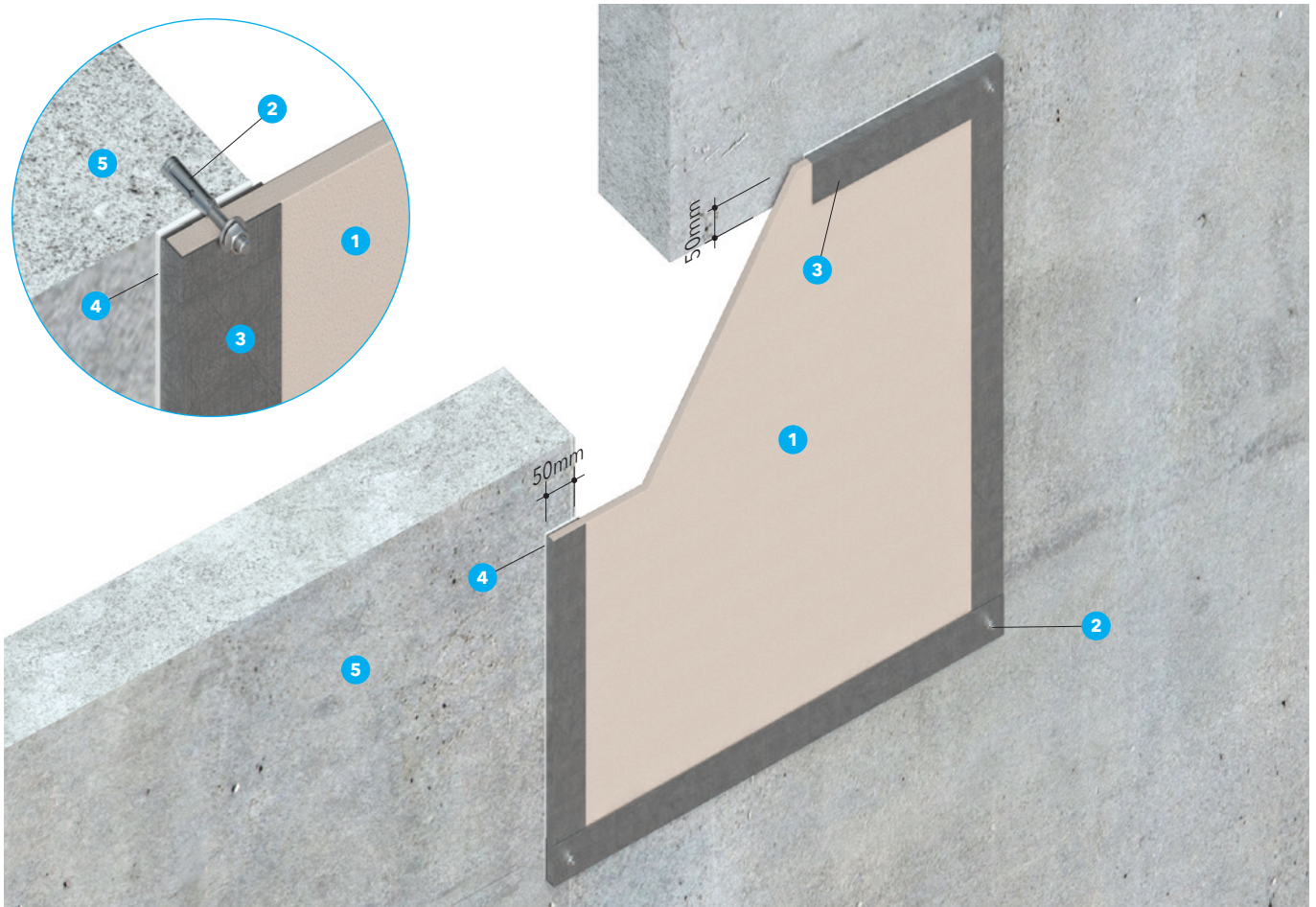
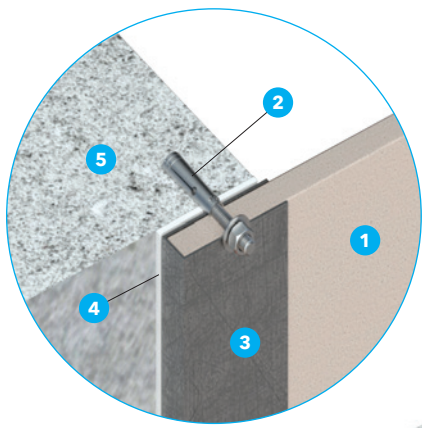

1. PROMATECT®-H board
2 hours: 9mm thick
4 hours: 12mm thick
2. M6 all-steel expanding anchors or M4 self-tapping screws with non-combustible plug.
3. Optional steel channel 50mm deep x 0.8mm thick.
4. PROMASEAL® Intumescent Acrylic Sealant.
5. Concrete wall.

PROMATECT®-H – 2-hour fire rated access panel (Integrity only)

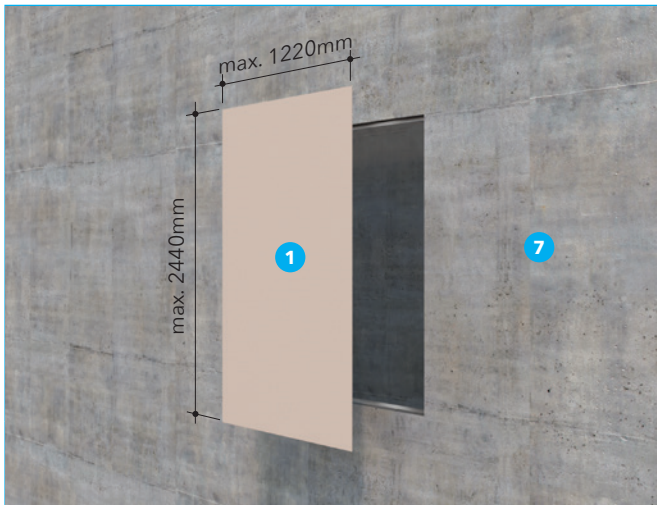

Fire Resistance	FRR	-/120/-	Model number: PH.18.12.E
	Standard	BS 476: Part 22: 1987	
	Approval	BRE cc 83300 review 7 issue 1	
Construction	Orientation	Vertical	
	Nature of connection	Masonry wall	
	Type	Fixed	

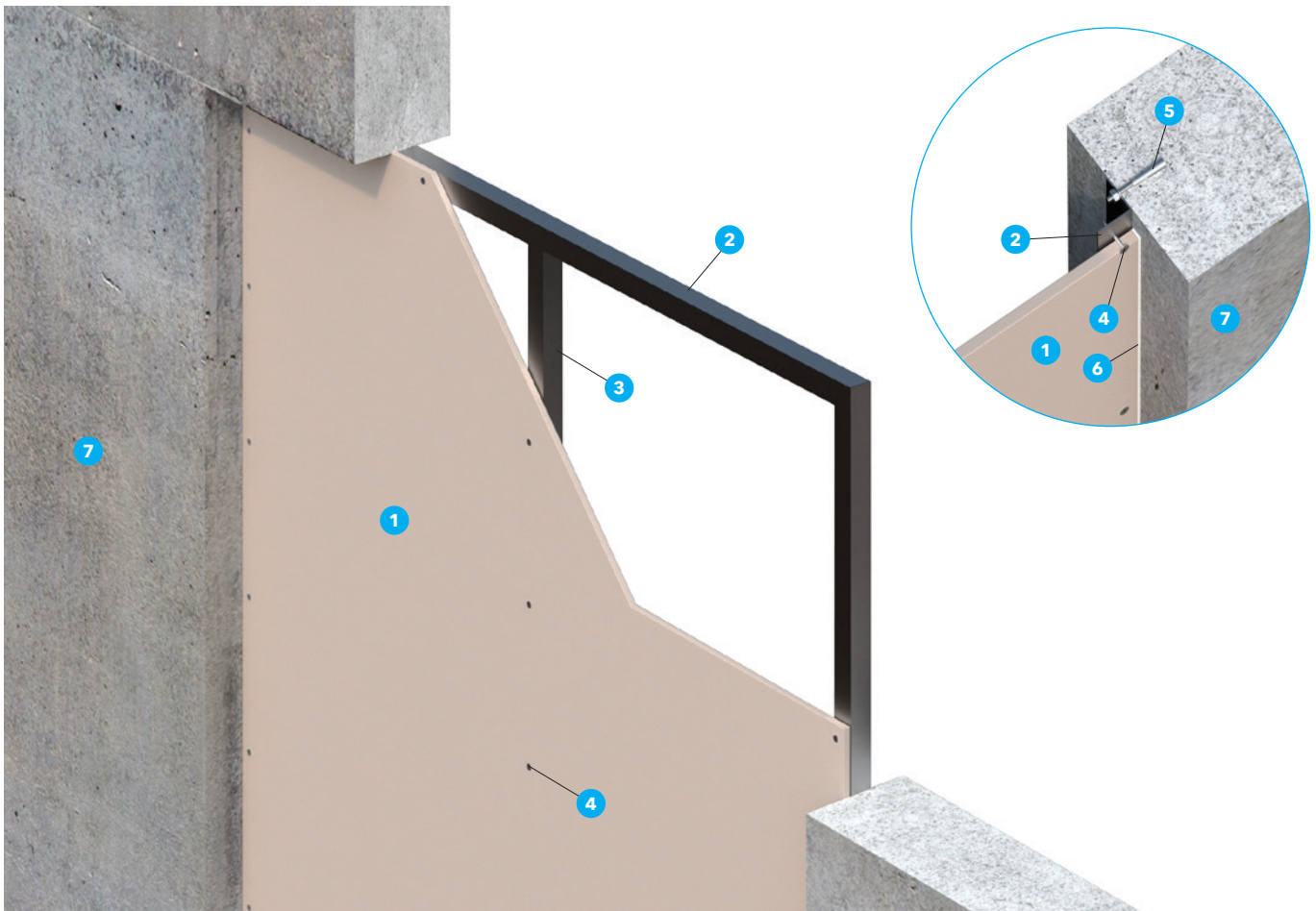

1. PROMATECT®-H board 9mm thick.
2. Steel angle 30 x 30 x 0.8mm thick.
3. Intermediated steel angle 30 x 30 x 0.8mm thick.
4. M4 self-tapping screws at nominal 200mm centres.
5. Steel screw with non-combustible plugs at 300mm centres / anchor bolt.
6. Seal small gaps around panel edge with PROMASEAL® Intumescent Acrylic Sealant.
7. Masonry wall.

PROMATECT®-S – 2-hour and 4-hour fire rated access panel (Integrity only)

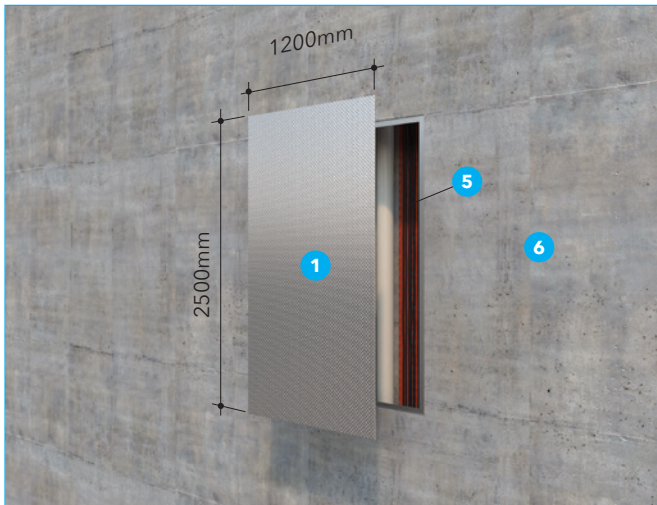

Fire Resistance	FRR	-/120/-	Model number: PS.18.12.E
		-/240/-	Model number: PS.18.24.E
	Standard	BS 476: Part 22: 1987	
Approval	RED R23L24-1A		
Construction	Orientation	Vertical	
	Nature of connection	Masonry wall	
	Type	Fixed	

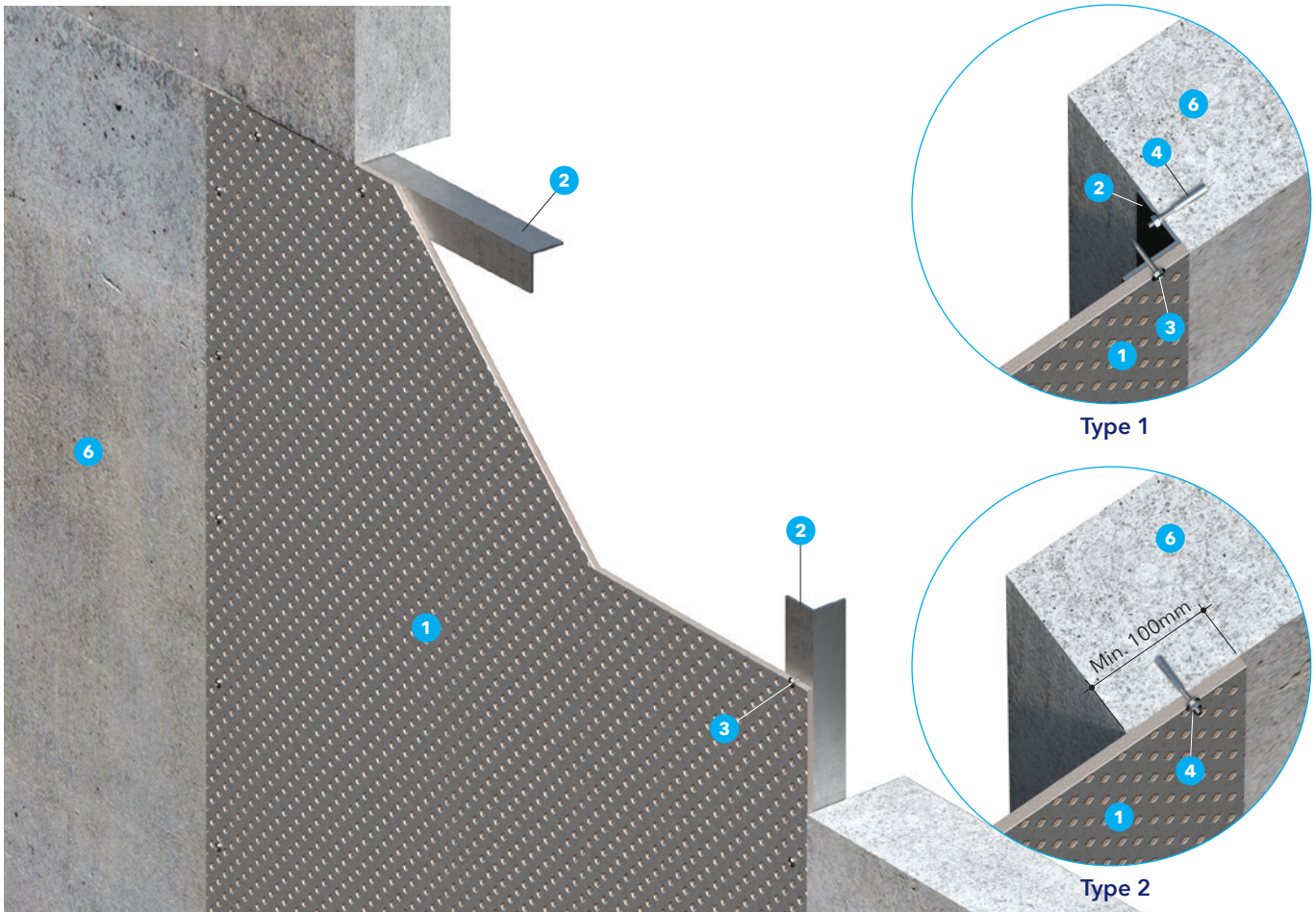

1. PROMATECT®-S board.
2 hours: 6mm thick
4 hours: 9.5mm thick
2. Steel angle 50 x 50 x 3mm thick.
3. Teks screws at nominal 200mm centers.
4. M6 x 40mm long anchor bolts at nominal 200mm centres.
5. General building services, eg. cables, pipes, etc.
6. Masonry wall.

PROMINA®-60 – 1-hour fire rated access panel

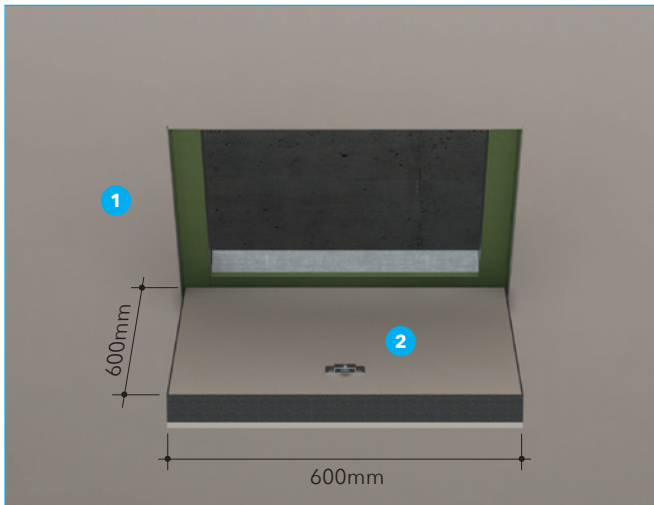

Fire Resistance	FRR	-/60/60	Model number: PMF.15.60
	Standard	BS 476: Part 22: 1987	
	Approval	WF 430406 issue 3	
Construction	Orientation	Horizontal	
	Nature of connection	Promat fire rated ceiling	
	Type	Hinged	

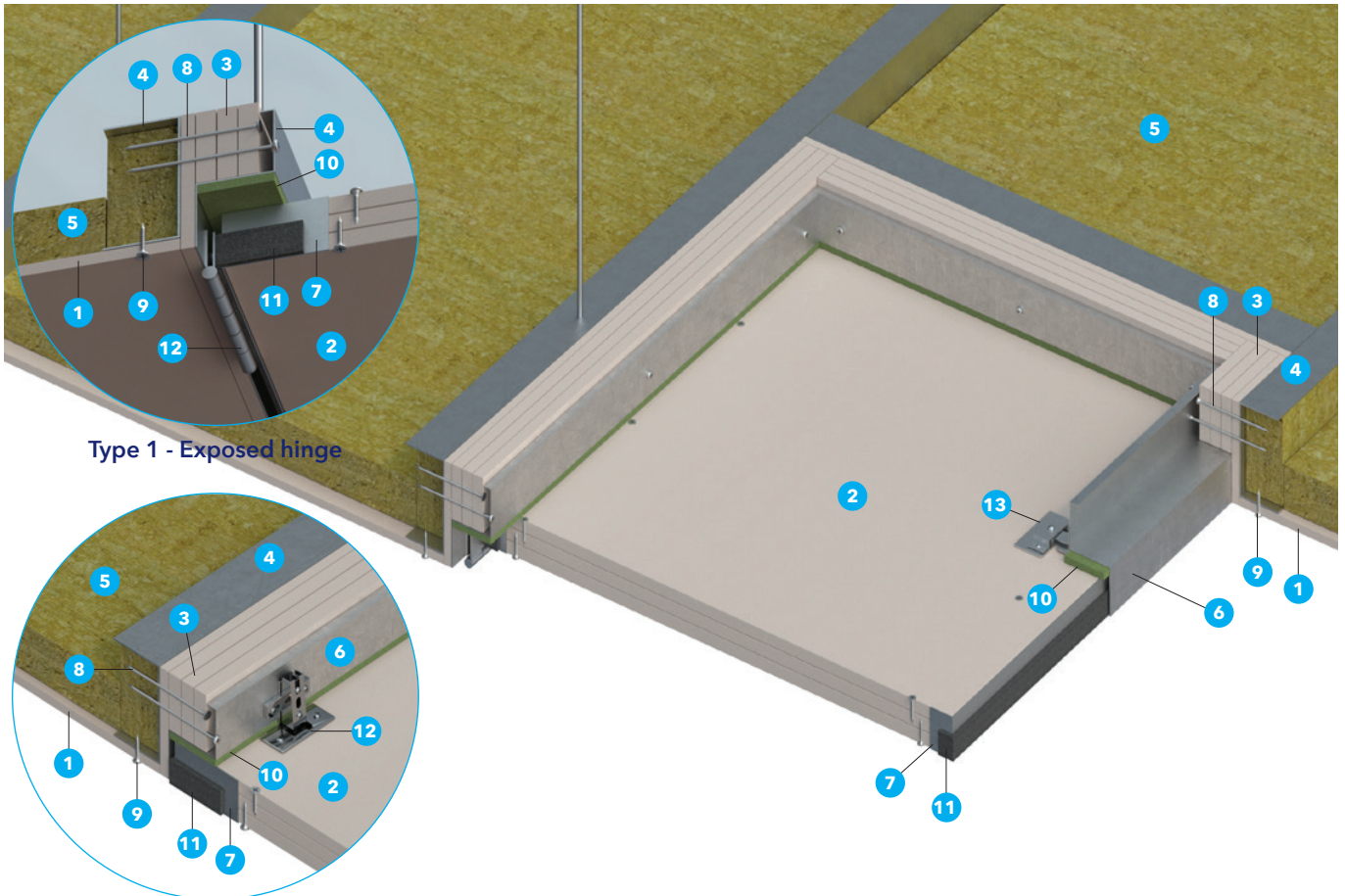

Type 1 - Exposed hinge

Type 2 - Concealed hinge

1. Promat fire rated ceiling.
2. Access panel 36mm thick form by PROMINA®-60 board 3 X 12mm thick.
3. PROMATECT®-H or PROMINA®-60 cover strips 12mm thick.
4. Steel channel 92 x 36 x 1.15mm thick.
5. Mineral wool min. 50mm thick x 60kg/m³.
6. Access panel frame 1.0mm thick
7. Door frame angle.
8. Drywall self-tapping screws No. 8 x 127mm.
9. Drywall self-tapping screws No. 8 x 38mm.
10. PROMASEAL® IBS™ 10mm thick x 50mm wide.
11. PROMASEAL® Intumescent strip 3mm thick x 25mm wide.
12. Hinges.
13. Budget lock.

PROMATECT®-L500 and PROMATECT®-H – 2-hour fire rated access panel

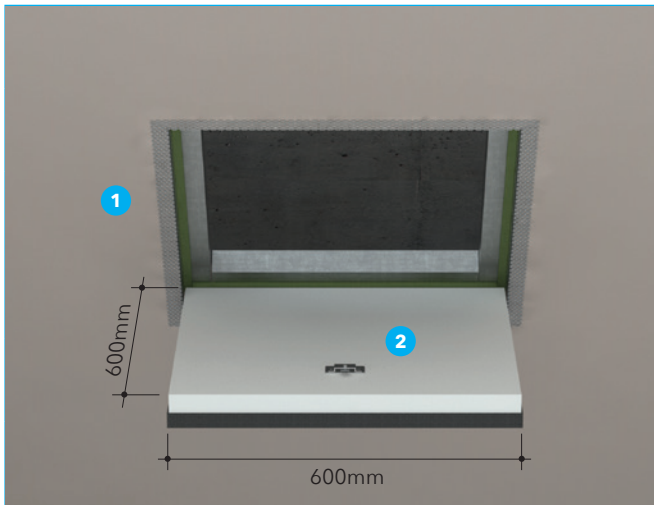

Fire Resistance	FRR	-/120/120	Model number: PE+PH.15.12
	Standard	BS 476: Part 20 and 22: 1987	
	Approval	FSRG 2018/033	
Construction	Orientation	Horizontal	
	Nature of connection	Promat fire rated ceiling	
	Type	Hinged	

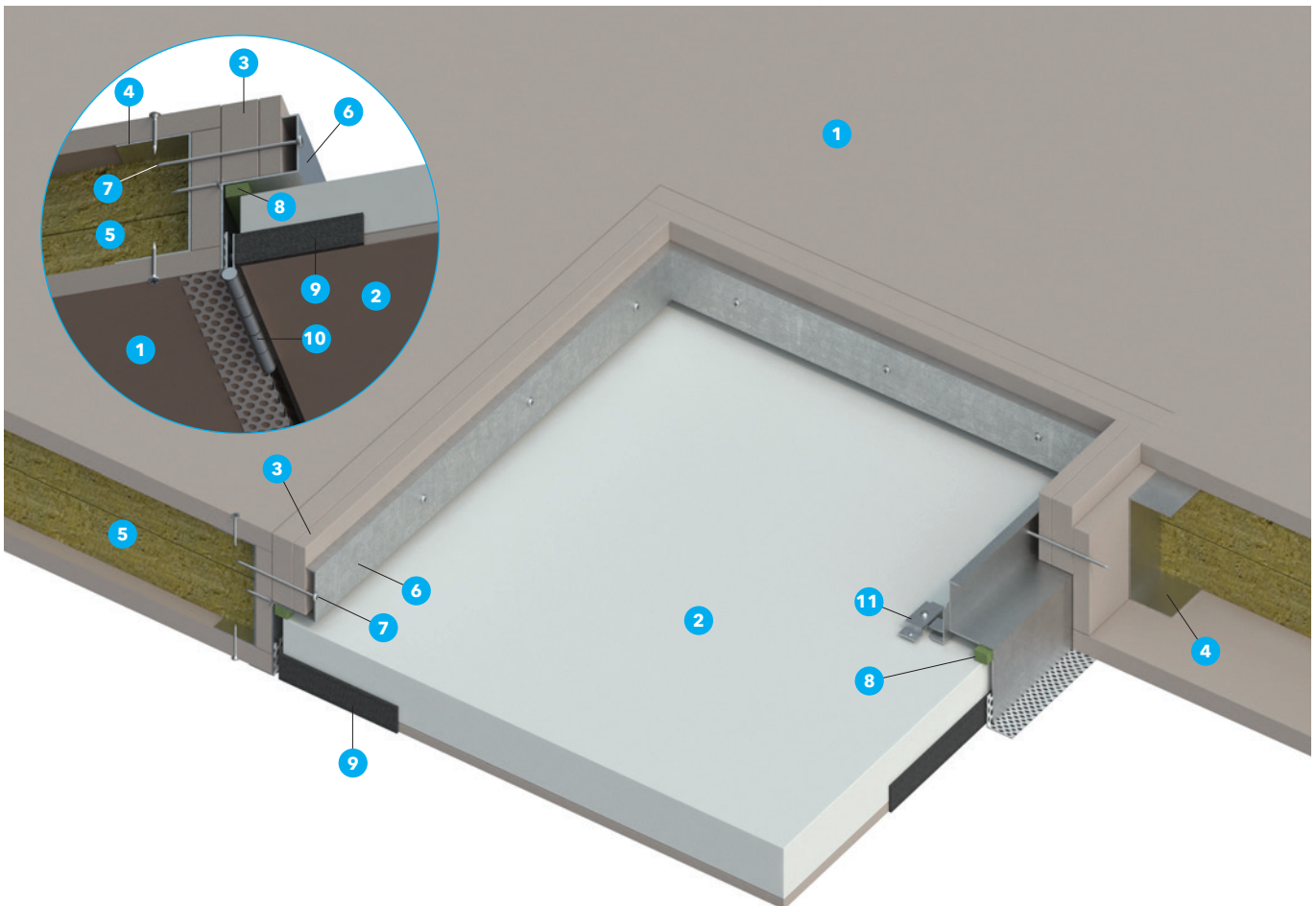

1. Promat fire rated ceiling.
2. Promat access panel 59mm thick form by PROMATECT®-L500 board 50mm thick and PROMATECT®-H board 9mm thick.
3. PROMATECT®-H cover strips 80mm wide x 25mm thick and 80mm wide x 15mm thick.
4. Steel channel 92 x 32 x 1.15mm thick.
5. Mineral wool 2 x 50mm thick x 100kg/m³.
6. Access panel frame 1.0mm thick
7. Drywall self-tapping screws No. 8 x 127mm.
8. PROMASEAL® IBS™ 10mm thick x 15mm wide.
9. PROMASEAL® Intumescent strip 3mm thick x 25mm wide.
10. Hinges.
11. Budget lock.

PROMATECT®-H – 2-hour and 4-hour fire rated access panel (Integrity only)

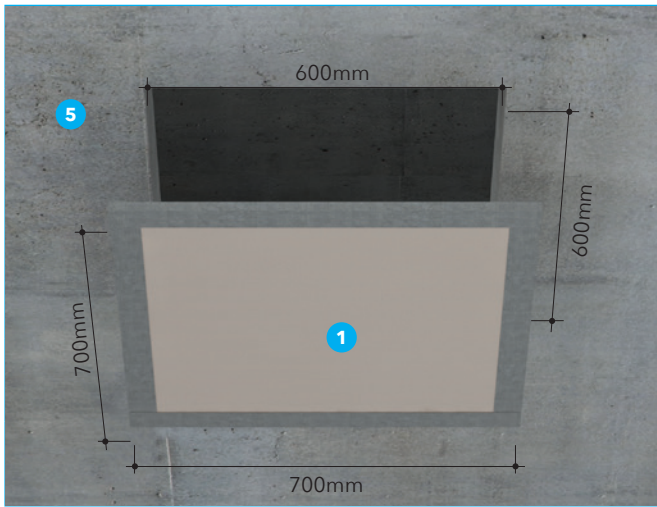

Fire Resistance	FRR	-/120/-	Model number: PH.17.12.E
		-/240/-	Model number: PH.17.24.E
	Standard	BS 476: Part 22: 1987	
Approval	WF 144342 issue 2		
Construction	Orientation	Horizontal	
	Nature of connection	Concrete floor	
	Type	Fixed	

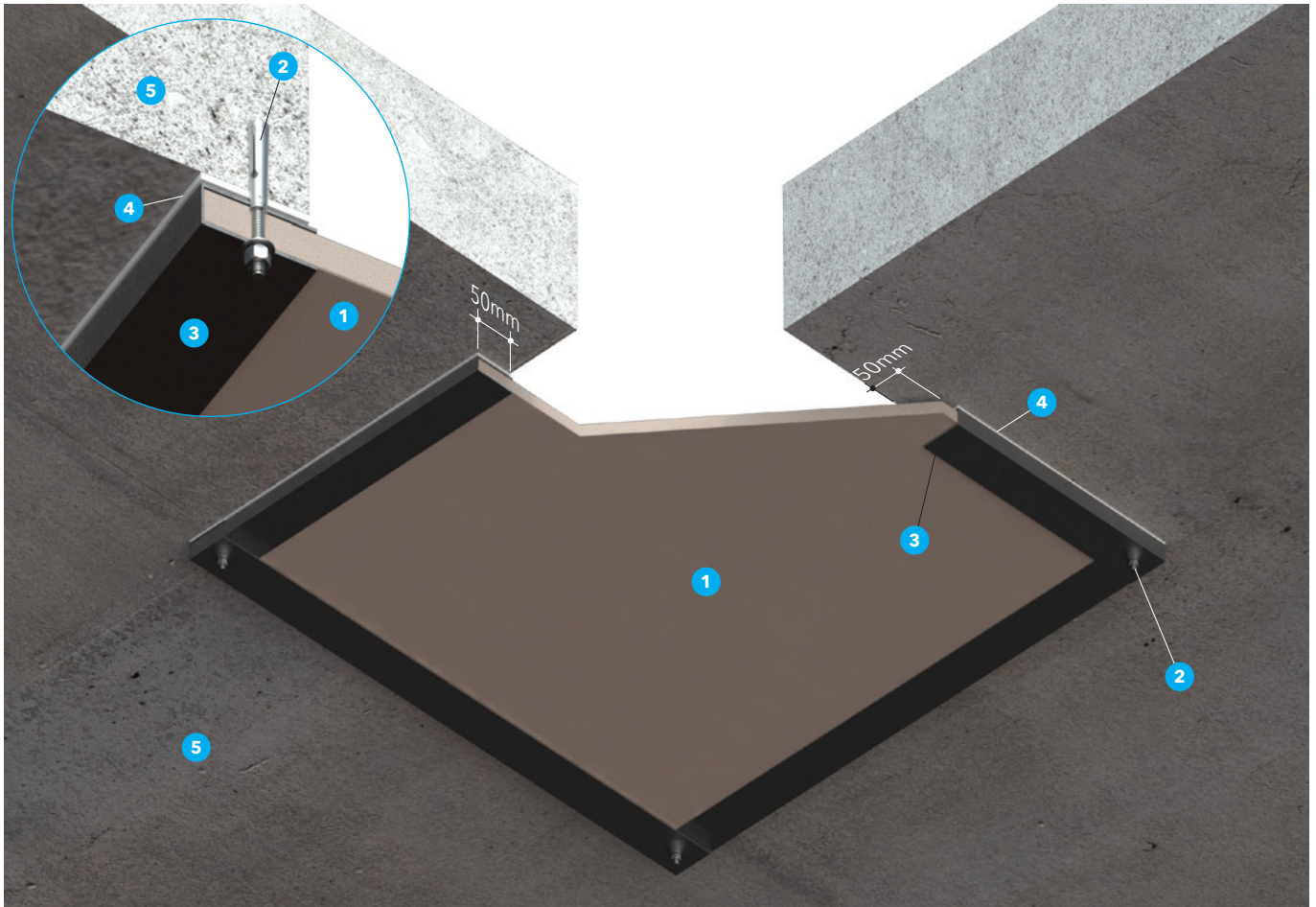

1. PROMATECT®-H board
2 hours: 9mm thick
4 hours: 12mm thick
2. M6 all-steel expanding anchors or M4 self-tapping screws with non-combustible plug.
3. Optional steel channel 50mm deep x 0.8mm thick.
4. PROMASEAL® Intumescent Acrylic Sealant.
5. Concrete wall.

PROMATECT®-H – 2-hour fire rated access panel

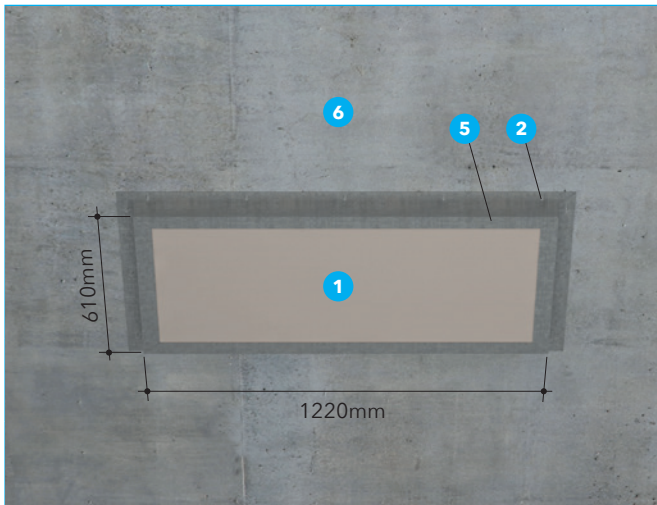

Fire Resistance	FRR	-/120/120	Model number: PH.15.12
	Standard	BS 476: Part 22: 1987	
	Approval	RED R23E19-1A	
Construction	Orientation	Horizontal	
	Nature of connection	Concrete floor	
	Type	Fixed	

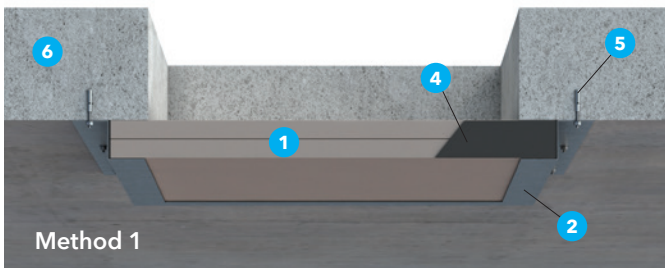
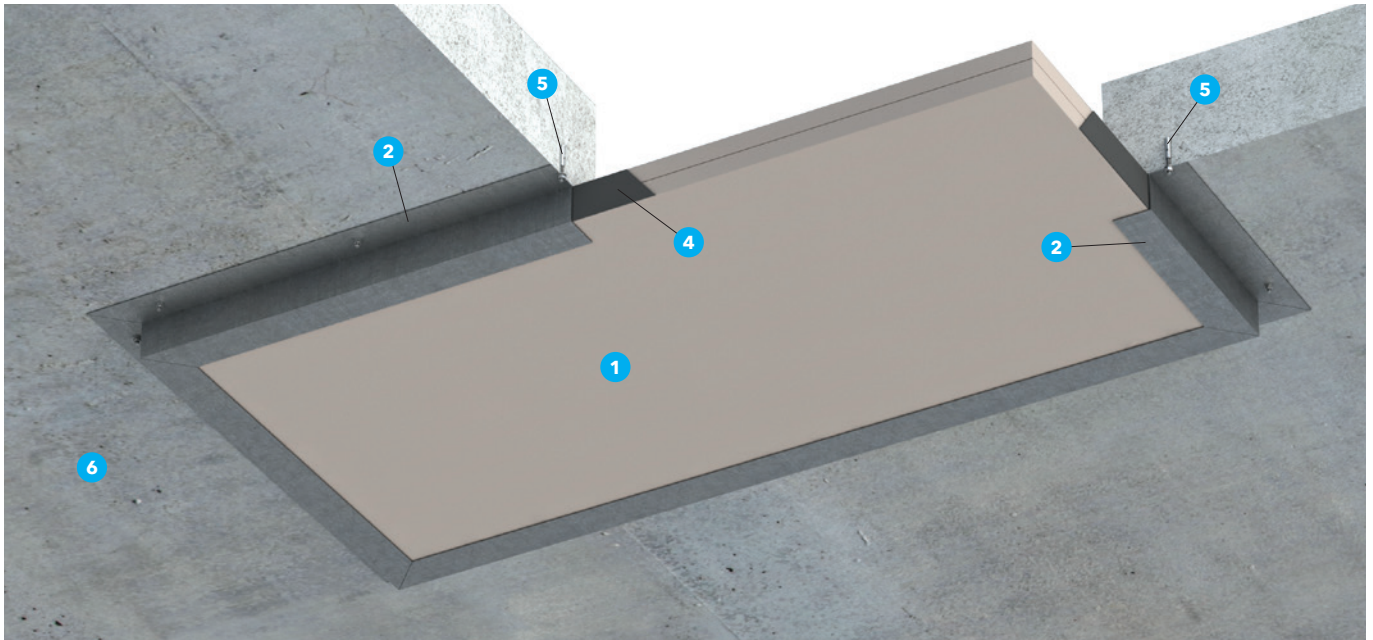

1. PROMATECT®-H board 2 x 25mm thick.
2. Z-section 50 x 50 x 50 x 1.5mm thick.
3. L-angle 50 x 50 x 1.5mm thick.
4. PROMASEAL® Intumescent strip 1.5mm thick at perimeter of panel.
5. M8 anchor bolt at 300mm centre.
6. Concrete floor.

PROMATECT®-H – 2-hour and 4-hour fire rated access panel (Integrity only)

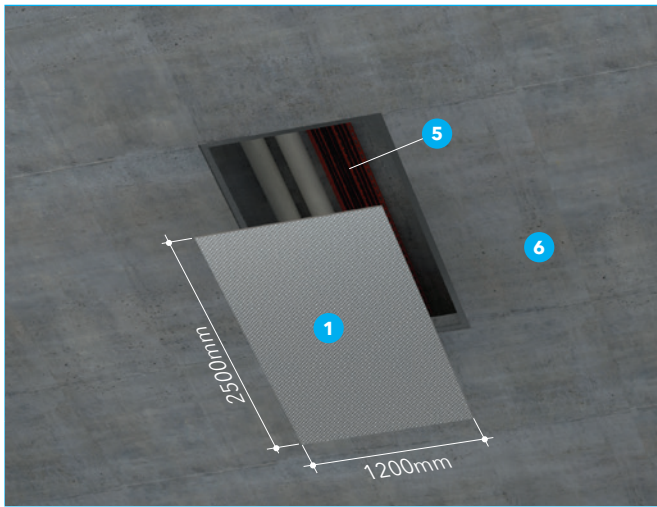

Fire Resistance	FRR	-/120/-	Model number: PS.15.12.E
		-/240/-	Model number: PS.15.24.E
	Standard	BS 476: Part 22: 1987	
	Approval	RED R23L24-1A	
Construction	Orientation	Horizontal	
	Nature of connection	Concrete floor	
	Type	Fixed	

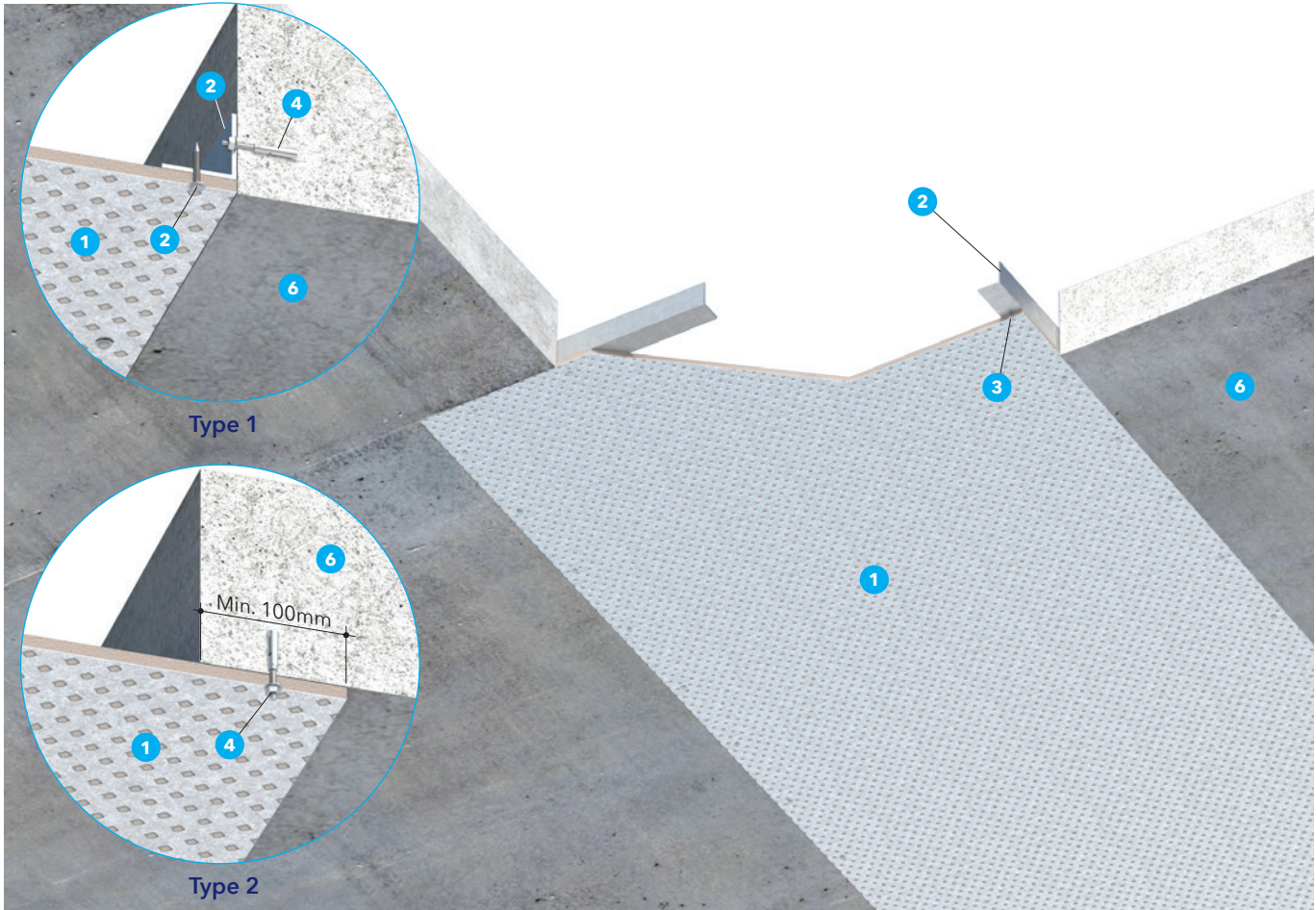

- 1. PROMATECT®-S board.
2 hours: 6mm thick
4 hours: 9.5mm thick
- 2. Steel angle 50 x 50 x 3mm thick.
- 3. Teks screws at nominal 200mm centers.
- 4. M6 x 40mm long anchor bolts at nominal 200mm centres.
- 5. General building services, eg. cables, pipes, etc.
- 6. Masonry wall.



www.promat.com



Promat Asia Pacific

Australia

Promat Australia Pty Ltd

South Australia office

1 Scotland Road
SA 5031 Mile End South
☎ 1800 Promat (776 628)
☎ +61 8 8352 1014
✉ PAPL.mail@etexgroup.com

New South Wales office

Unit 1, 175 Briens Road
Northmead, NSW 2152
☎ 1800 Promat (776 628)
☎ +61 2 9630 0258
✉ PAPL.mail@etexgroup.com

Victoria office

Unit 1, 355 Grieve Parade
Altona North, VIC 3025
☎ 1800 Promat (776 628)
☎ 1800 334 598
✉ PAPL.mail@etexgroup.com

Queensland office

80 Stradbroke St
Heathwood QLD 4110
☎ 1800 011 376
☎ 1800 334 598
✉ PAPL.mail@etexgroup.com

China

Promat Shanghai Ltd

No.2, Tai Hua Street
Yonghe Economic District
Guangzhou City
Guangdong Province 511356
☎ +86 20 8136 1167
✉ promat.cn@etexgroup.com

Hong Kong

Promat International (Asia Pacific) Ltd

Room 1010, C.C. Wu Building
302-308 Hennessy Road
Wanchai
☎ +852 2836 3692
✉ promat.hk@etexgroup.com

Malaysia

Etex Malaysia Sdn Bhd

Unit 19-02-01, Level 2, Wisma Tune
19 Lorong Dungun, Damansara Heights
50490 Kuala Lumpur
☎ +60 3 2095 8555
✉ promat.my@etexgroup.com

Singapore

Promat Building System Pte Ltd

10 Science Park Road, #03-02 The Alpha
Singapore Science Park II
117684 Singapore
☎ +65 6776 7635
✉ promat.sg@etexgroup.com

- The technical data provided in this publication is based on mean values prevalent at time of publication and is thus subject to fluctuation. It should not be regarded as a guarantee to system performance.
- All data contained herein conforms to and frequently surpasses generally accepted fire protection standards recognised by most professional fire science practitioners and regulatory authorities worldwide. The same general principle is equally applicable to all Promat products and systems. Promat has access to a considerable body of test authentication data and this can be provided on a complimentary basis upon request. It should be noted however that this publication replaces all previous editions in its entirety.
- This document is protected by International copyright laws. Reproduction and distribution in whole or in part without prior written permission is strictly prohibited. PROMAT, PROMATECT, PROMASEAL, PROMINA and logos are registered trademarks of Etex NV or an affiliate thereof in Hong Kong. Any use without authorisation is prohibited and may violate trademark laws.

About Etex

Etex is a global building material manufacturer and pioneer in lightweight construction. Etex wants to inspire people around the world to build living spaces that are ever more safe, sustainable, smart and beautiful.

Founded in 1905, headquartered in Zaventem, Belgium, Etex is a family-owned company with more than 13,500 employees globally. It operates more than 160 sites in 45 countries and recorded a revenue of EUR 3.7 billion in 2022. Etex fosters a collaborative and caring culture, a pioneering spirit and a passion to always do better for its customers.

Etex has five R&D centres supporting five global divisions:

- Building Performance: dry construction solutions including plasterboards and fibre cement boards, plasters and formulated products, passive fire protection and associated products.
- Exteriors: a range of aesthetic fibre cement materials for use in agriculture, architectural and residential exteriors.
- Industry: fire protection and high-performance insulation products for the construction and OEM (Original Equipment Manufacturer) industries.
- Insulation: glass mineral wool and extruded polystyrene (XPS) for thermal and acoustic insulation.
- New Ways: high-tech offsite modular solutions based on wood and steel framing.

Etex's global portfolio includes leading commercial brands such as Promat, Kalsi, Siniat, Equitone, Eternit, Cedral, Durlock, Gyplac, Pladur, Superboard and URSA.

Etex is Inspiring Ways of Living, for more information, please visit our website: www.etexgroup.com

