



KalsiFloor

Installation Guide



An industrial company with a proven history and a promising future

What we do

Improving our customers' quality of living with ever more effective lightweight solutions.



Building Performance
Leader in plasterboards and fibre cement boards, and the global reference in passive fire protection solutions for the residential and commercial segments.



Exteriors
Provider of innovative, durable, high performance and beautiful fibre cement exterior materials for architectural, residential and agricultural projects.



Industry
Front runner of engineering expertise to drive the future of high performance thermal and acoustic insulation as well as passive fire protection in the industrial, aerospace and energy sectors.



New Ways
New Ways offers high-tech, lightweight, factory-assembled panel and modular solutions based on timber and steel framing.

Strong manufacturing **global footprint**

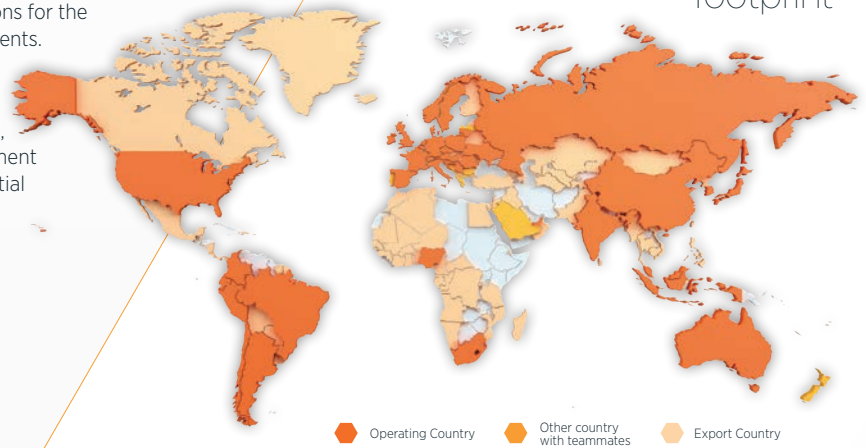

>140
Sites: plants, quarries, offices.

45
Operating countries

>13,500
Teammates

* On 11 January 2022, Etex announced the acquisition of thermal and acoustic insulation expert URSA. When completed, this operation will lead to the incorporation of URSA as a separate division dedicated to insulation activities. Etex's Annual Report will reflect this new structure as of its 2022 edition.

Our main Commercial Brands

CEDRAL

DURLOCK

Eternit

EQUITONE

Gyplac

Kalsi

PLADUR

Euronit

Promat

Superboard

siniat

URSA

Inspiring ways of living

Our why
We want to inspire people around the world to build living spaces that are ever more safe, sustainable, smart and beautiful.

Our how
We work as one, fostering a collaborative and caring culture, a pioneering spirit and a passion to always do better for our customers.

Our what
Building on our experience and global market needs, we strive to improve our customers quality of living with ever more effective lightweight solutions.

Over a century of sustainable profitable growth

1905

Creation

Alphonse Emsens founds the Eternit fibre cement factory in Haren near Brussels in 1905 after acquiring the manufacturing technology from Austrian industrialist Ludwig Hatschek.

1937

Geographic expansion

Eternit expands across Europe and invests in important overseas export markets in Latin America.

1957

Technological diversification

The company begins to diversify and adds plasterboard to its production portfolio.

2003

Split into two entities

Split of the group into the entities: Etex for building materials activities and Aliaxis for plastic activities.

2018-2019

Focus on lightweight construction

Etex confirms its strategic shift to a lightweight construction specialist: while creating the JV E2E together with Arauco, it divests two clay and concrete roof tile businesses.

Contents

About KalsiFloor _____	4
Scope of use _____	6
Benefits of KalsiFloor _____	6
Certifications _____	6
Best installation practices _____	7
Working with KalsiFloor _____	9
Framing recommendation _____	10
Layout & standard details _____	11
Installation details _____	12
Finishing _____	17
Painting/top coats _____	18





KalsiFloor

KalsiFloor is a non-combustible fibre cement panel, manufactured from a precise combination of cement, silica and natural organic reinforcing fibres. During the production, the boards are cured and stabilised in an autoclave process involving high temperature and pressure, ensuring a final product with optimum dimensional stability and exceptional mechanical properties to deliver superior building performance.

KalsiFloor is manufactured to conform to the requirements of AS/NZS2908.2: 2000, as classified as Type A Category 3.

KalsiFloor Technical Specifications

Dimensions

Length (mm)	Width (mm)	Thickness (mm)	Weight (kg/m ²)
2400	1200	20	28.40
1800	1200	20	28.40

Surface finish

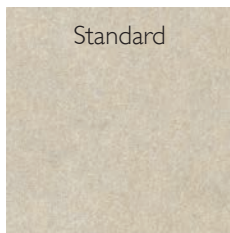

Edge finish

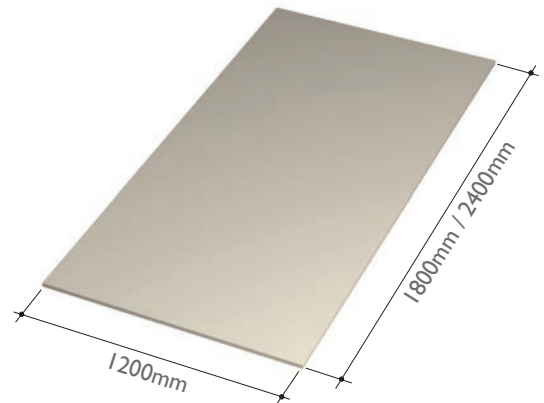
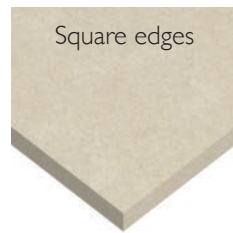

KalsiFloor General Properties

General Technical Properties

Dimensional Conformity (tested to AS/NZS 2908.2)		Pass
Length	mm	± 8
Width	mm	± 5
Thickness		± 10%
Straightness of edges	mm/m	3
Squareness of edges	mm/m	4
Density (tested to AS/NZS 2908.2)	kg/m ³	≥1250
Modulus of rupture (tested to AS/NZS 2908.2) (Type A .Category 3)	MPa	≥7
Water permeability (tested to AS/NZS 2908.2)		Pass
Moisture content (tested to ASTM C1185)		≤15%
Water absorption (tested to ASTM C1185)		≤33%
Moisture movement (tested to ASTM C1185)		≤0.04%
Thermal conductivity (tested to ASTM C518-76)	W/m ² K	0.27

Reaction To Fire

Combustibility (ENI 3501-1+A1)	A1 Non-Combustible
Surface spread of flame (tested to BS 476 Part 7)	Class I
Fire propagation index (tested to BS 476 Part 6)	I = 1.6
Fire Hazard Properties (tested to AS/NZS 1530.3)	
Ignitability Index	0
Spread of Flame Index	0
Heat Evolved Index	0
Smoke Developed Index	0-1

Scope of Use, Benefits and Certifications

Scope of Use

KalsiFloor is a product that can be used for both interior and semi exposed flooring applications in both commercial and residential lightweight framed construction. Compared to wood based panels, KalsiFloor is advantageous due to its superior moisture, impact and fire resistance while being an excellent substrate to install ceramic tiles.

KalsiFloor is supplied in a variety of sizes and can be installed for either steel or timber frame designs including;

- Modular and portable buildings
- Mezzanine and interior framed floors
- Internal wet areas such as bathrooms and laundries.
- Exterior applications such as balconies, verandas, or sun decks.

Benefits of KalsiFloor

KalsiFloor is an advanced green building material that is suitable for internal intermediate/ laid-on flooring applications;

- can be directly finished with carpeting, vinyl or tiles
- can be finished with mortar screed/ high performance coating in high performance applications

It is a superb alternative to wood-based panels and concrete slabs flooring by offering durable and incredibly lightweight solution with simple, fast and clean construction.

- Resistant to the attack of termites, insects and other vermin
- Moisture, mould and water resistant
- Speed of installation
- Impact resistant
- Lightweight solution
- Non-combustible
- High mechanical strength
- Durable
- Does not swell

**Kalsi is the perfect
balance of resistance,
durability, and
functionality.**



HKGLS Code No. GL-008-011
Certification No. HK02262



Taiwan Green Label
Certificate

Certifications

All Etex Building Performance Indonesia products are manufactured in line with the ISO standards. Etex Building Performance Indonesia manufacturing facility achieved the certificates of ISO 9001:2008, ISO 14001:2015 and OHSAS 18001:2007. These certificates can be downloaded from www.kalsi-building-solutions.com



Best Installation Practices

General Guidelines

Storage

All Kalsi boards must be stored flat on pallets and placed inside covered and dry conditions, optimising protection for stored boards against exposure to weather and other unfavourable conditions.

Ensure the boards are stacked on flat ground and supported with level bearers. Improper stacking and/or on an unlevelled surfaces may result in permanent deformation that causes unsightly appearance such as waviness (especially for planks).

Boards are preferably stored under a protected shade. If stored outdoors, it must be covered from the effects of weathering agents such as rainwater and sunlight exposure. Allow wet boards/planks to dry to equilibrium under natural ventilated conditions prior to any installation.



Handling & Lifting the Floor Panels

Never carry Kalsi boards/planks on flat and middle position, as this increases the likelihood of breakage.



Hold it vertically on the Edge as Figure above.

When single person lifting, hold it vertically in the middle and spread hands as far as possible to provide maximum support to suit the length of the panel (up to 2,400mm).

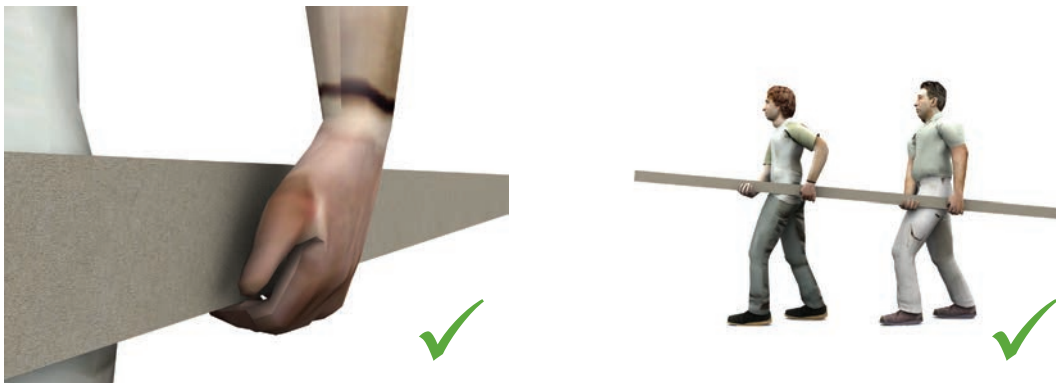

It is recommended to be carried by 2 persons at two ends as in Figure above.

Best Installation Practices

On-Site Practices

Store sheets neatly on flat surface, clear off the ground to avoid damage and moisture ingress. Bearers to be spaced at 600mm centre maximum as below;

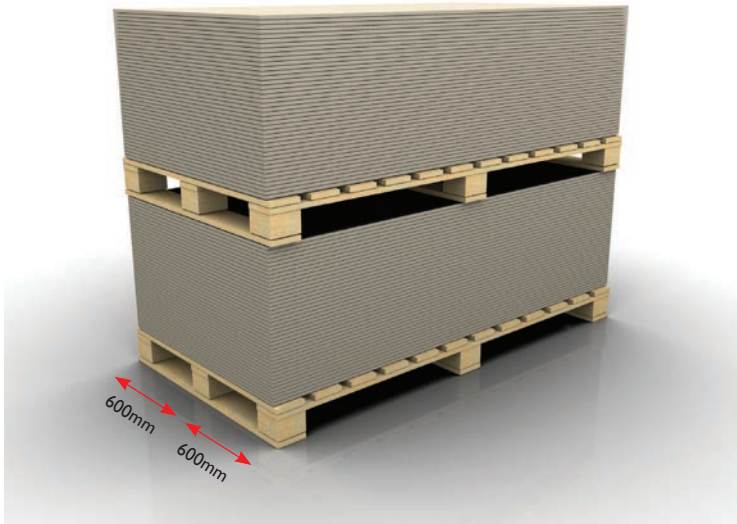

Never install damp sheets, if the boards or planks have been wetted, allow to dry to Equilibrium Moisture Content before lifting and fixing the boards.

Kindly refer to fixing recommendation and framing details for the boards as per its intended application.



Working with KalsiFloor

Recommended Tools and Equipment

Sawing machines such as Festool, Makita, Bosch, DeWalt etc work with a tungsten carbide tipped saw blade on a low speed and used over a fixed working table.

Typically, used on site producing good results of cutting Kalsi Boards with thickness up to 20mm.

Dust Extraction with HEPA filters are recommended for cutting with power saws. As additional safety precautions, always wear eye, ear and dust protection when using power tools of any type.



Cutting and Special Processes

It is extremely important to remember that Kalsi boards are made of abrasive materials that require special tools for cutting and machining.

Keep in mind the following recommendations:

- Use abrasion resistant cutting tools of tungsten carbide or diamond tipped saws.
- Avoid too much generation / inhaling of dust by cutting in well-ventilated areas.
- For higher thickness up to 20mm, use power saw machines such as table saw, circular saw or jigsaw.
- By using power jigsaw, boards can be cut easily into various shapes including curved lines.

Important points to take note:

- 1) Ensure boards to be cut are continuous and well supported on either side of the cut.
- 2) Straight edge should be clamped in position to guide cutting operation.
- 3) Cutting rate should be such that the blade is not labouring or over-heating.



- Drilling and Holes Opening

Boards can be perforated using any power drill with a hollow drill bit of tungsten carbide tips OR by drilling successive small holes.



Framing Recommendation

KalsiFloor can be installed in both steel purlins or timber joists and must be of minimum face width of 45mm for the efficient bearing of the panel, especially at joints.

Metal framing must comply with New Zealand NASH 3405 Standard.

Timber framing must comply with New Zealand Standard 3604 – Residential Timber Structures.

Other steel profiles or timber framings with adequate strength to suit the functional loads (which vary based on project specification) can be considered. Designers should consider all relevant local design standards including but not limited to NZS 3603 Timber Structures Standard, AS/NZS 1170 Structural Design Actions.

Note: It is the responsibility of the structural engineer to code-check the floor framing design to its relevant/ applicable local codes and standards, thus, ensuring the performance of the framing system in which the KalsiFloor panel will be laid on.

Loading

KalsiFloor complies with the minimum loading requirements set out in AS/NZS 1170.1 Table 3.1 Category A Domestic and Residential Activities for Concentrated Loads of 1.8kN on a 350mm² area. For other commercial and residential applications concentrated loads are tested on a 100mm square applicator, the below table sets out the tested performance:

Joist Spacing	Concentrated Load	
	Load Applicator Size 115mm (kN)	Point Load Load Applicator Size 350mm ² (kN)
450mm	6.6	2.7
600mm	4.9	2.5

Wet Area Applications

For wet area installation, it is also recommended to adjust flooring support to allow for a minimum 1:60 fall using a minimum mortar bed of 25mm.

The installation of all waterproofing systems is to comply with the requirements of NZBC E-3 Internal Moisture and AS 3740.

Exterior Decking Application

Water proof decks or balconies should be employed where the space below the deck will be used as habitable space NZBC E2/AS1 Section 7.1.2 provides guidance on enclosed deck design and construction waterproof membrane complying to NZBC E2/AS1 must be installed as per the manufacture instructions.

Flexible screed and bedding compounds must be used.



Layout & Standard Details

Fixing Details

Use self tapping screws (with self drilling head) to fix panel into timber studs or metal frame.

Minimum 8G of 38mm length for metal purlins and 45mm length for timber stud.

The durability of fixings should meet all minimum requirements of NZBC.

All fasteners to minimum Class 3 corrosion resistance, or greater.

KalsiFloor Thickness	Maximum Joist Centres	Fixings Centres
20mm	450mm	250mm/300mm

For thick boards and/ or thickness of steel joist channel (if more than 1.15mm), it is recommended to pre-drill before screwing for better control of cracks. Screw to be covered up with filler before coating over for aesthetic purposes and better protection against water ingress through fixing points.

Installation Layout

Recommended 2mm gap between butt joints are filled with a 2K epoxy or flexible sealant as allowance for lateral movement.

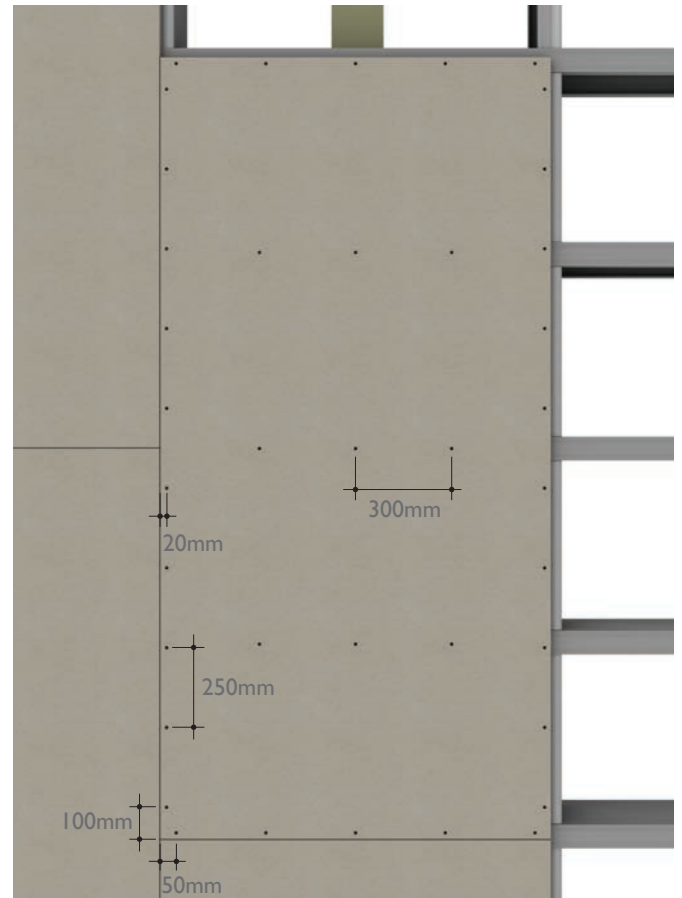

Figure 1
Installation layout

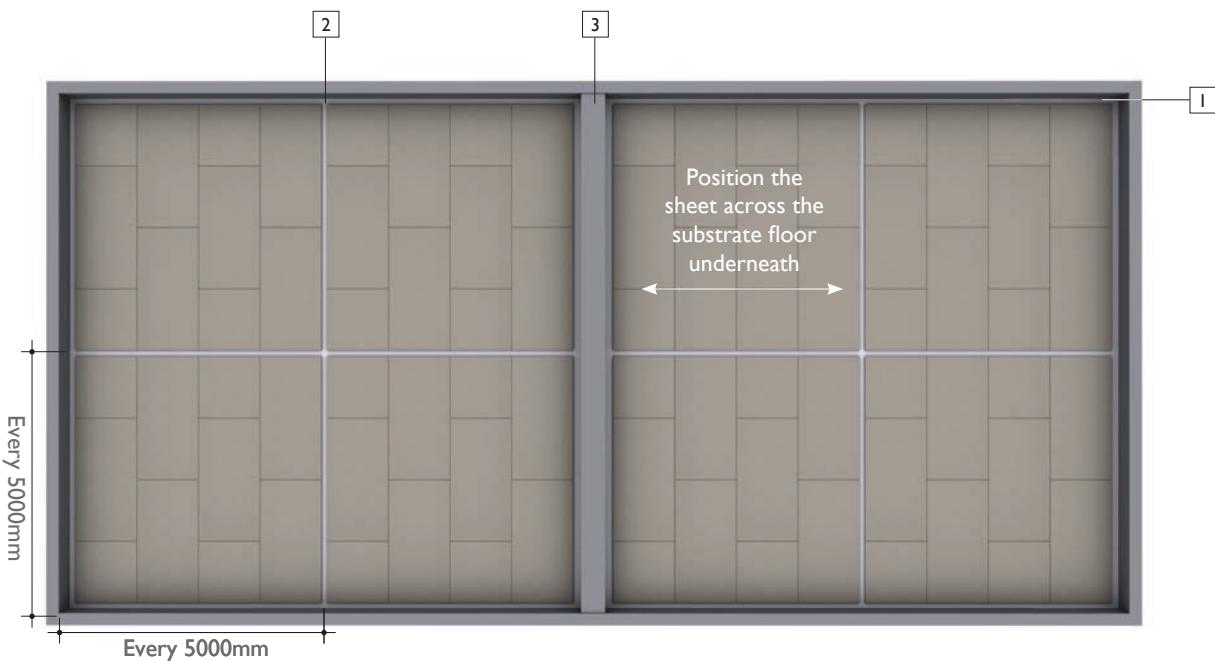

Figure 2
Movement and perimeter joints

1. Perimetral dilatation (5mm from walls and perimetral boundaries)
2. Movement joints
3. Walls and perimetral boundaries

Installation details

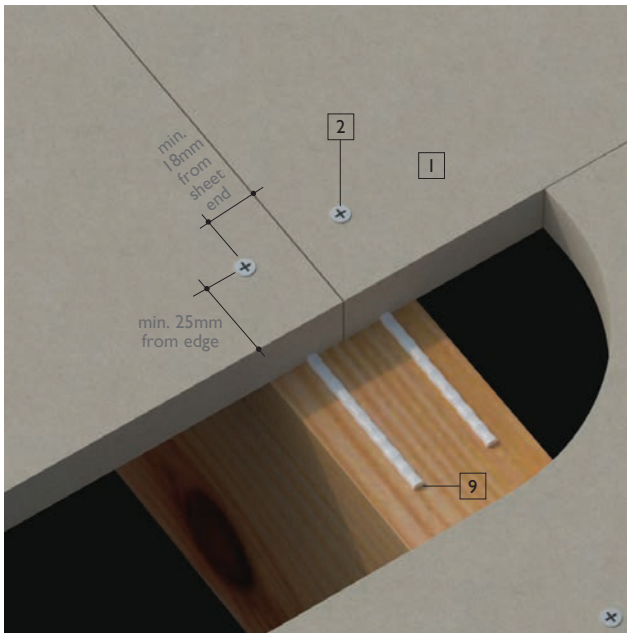

Figure 3
Butt joints - Internal dry areas

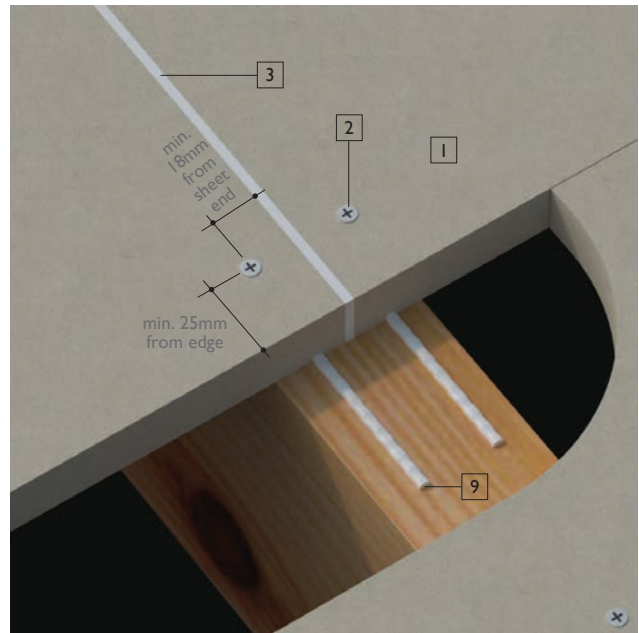

Figure 4
Butt joints - Wet areas

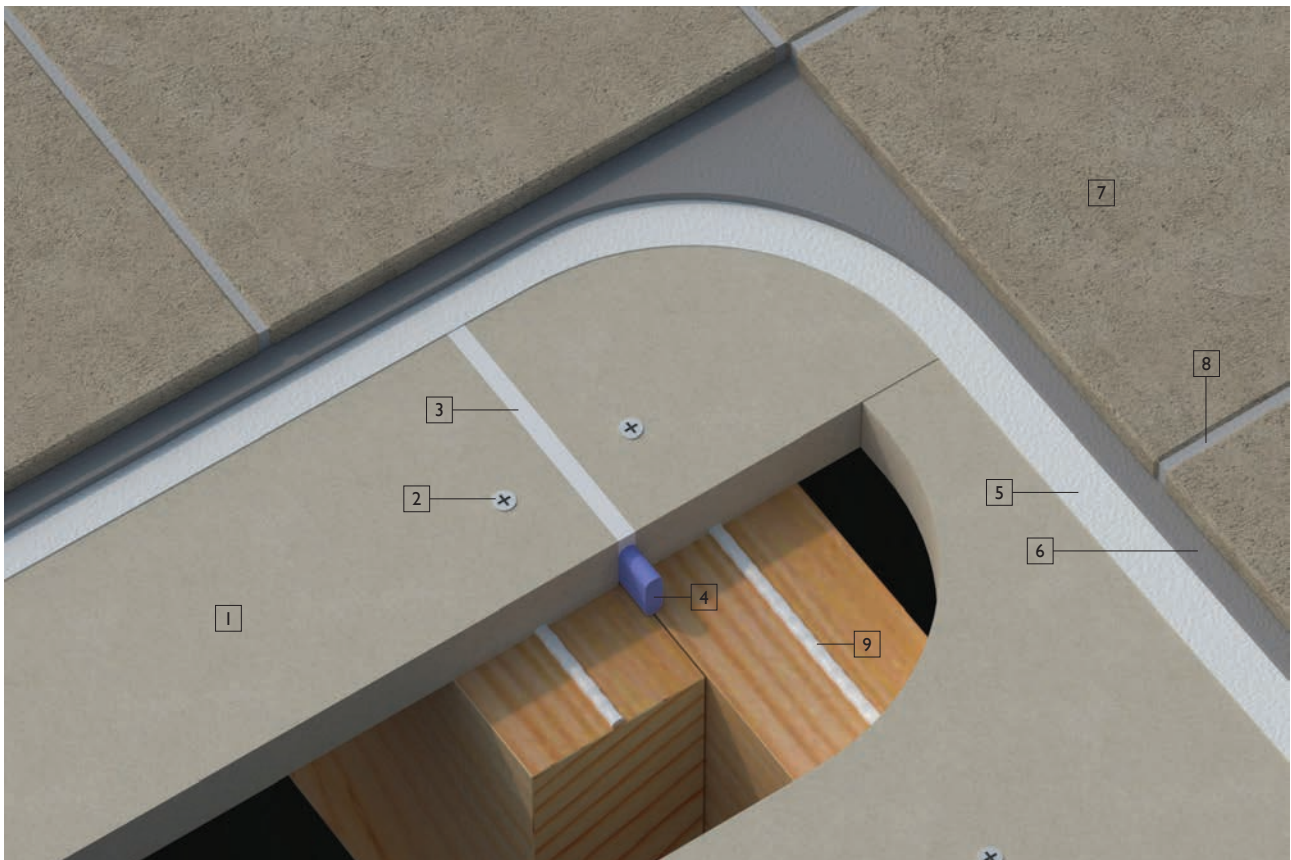

Figure 5
Control joints - Non wet area

- | | | |
|-------------------------|------------------|---|
| 1. KalsiFloor | 5. Primer | 8. Tile joint filled with polyurethane sealant and in line with sheet tongue and groove |
| 2. Screw | 6. Tile adhesive | 9. Construction adhesive |
| 3. Polyurethane sealant | 7. Tiles | |
| 4. Backing rod | | |

Installation details

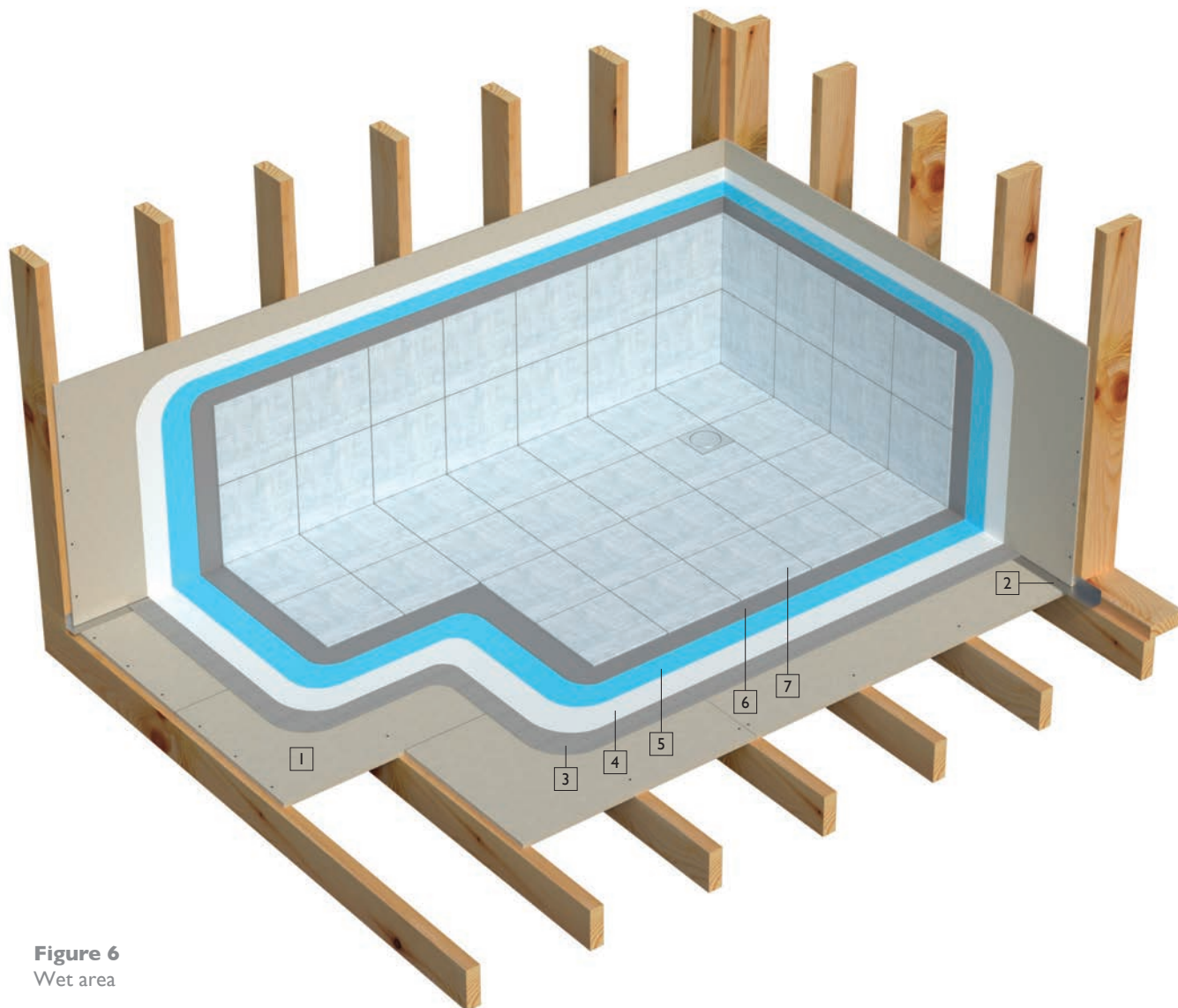

Figure 6
Wet area

1. KalsiFloor
2. Perimeter flashing - compliant to NZBC E-3
3. Mortar bed
4. Primer
5. Waterproof membrane
6. Tile adhesive
7. Tiles

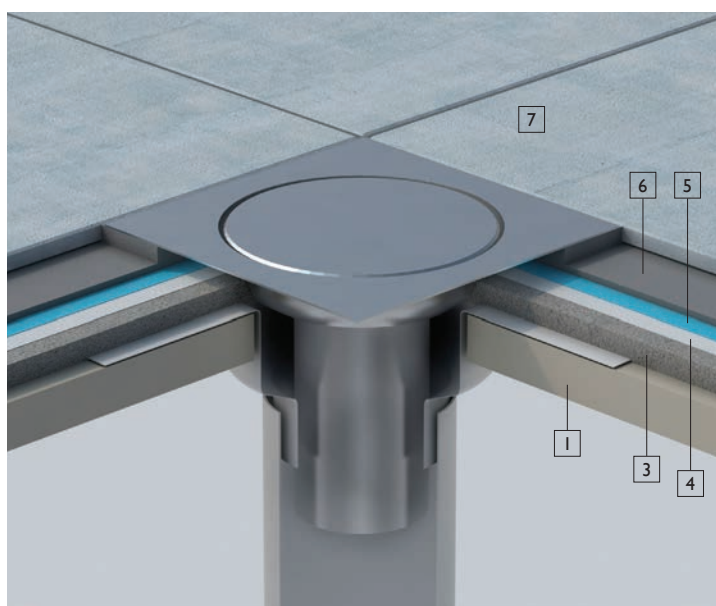

Figure 7
Floor waste

Installation details

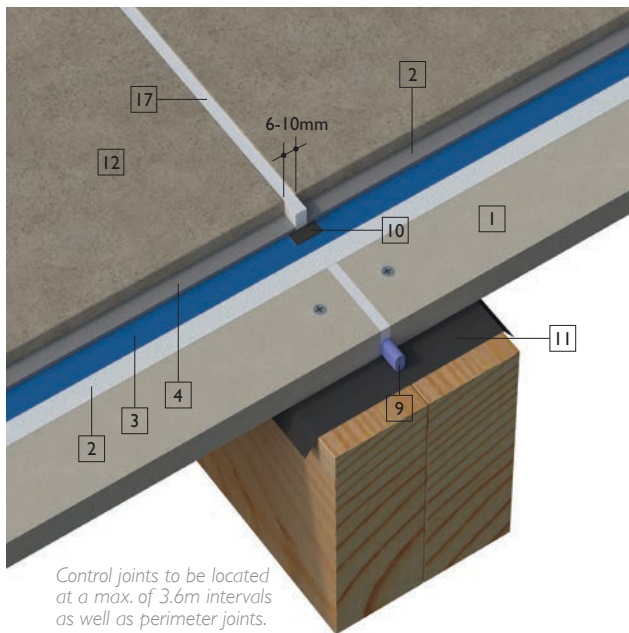

Figure 8
Control joints - Exterior deck

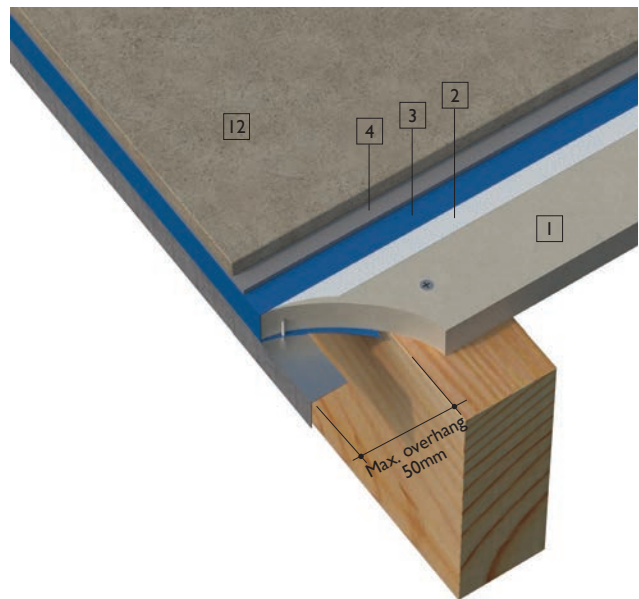

Figure 9
Deck finishing - Exterior deck

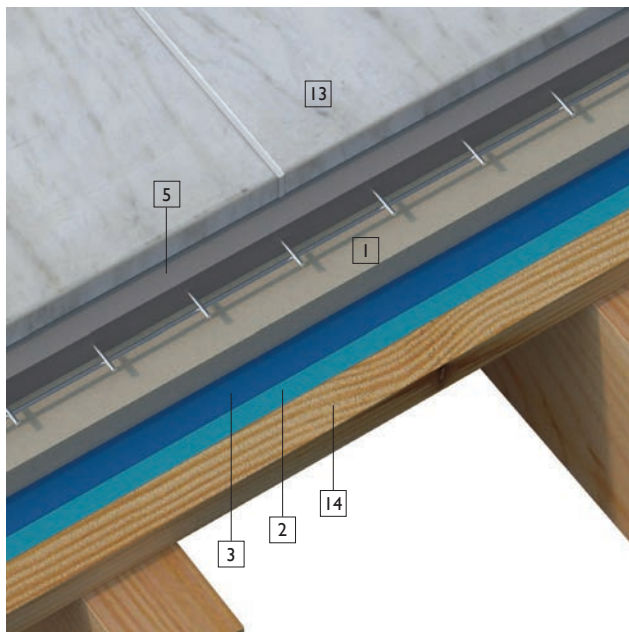

Figure 10
Marble floor tiles - Exterior deck

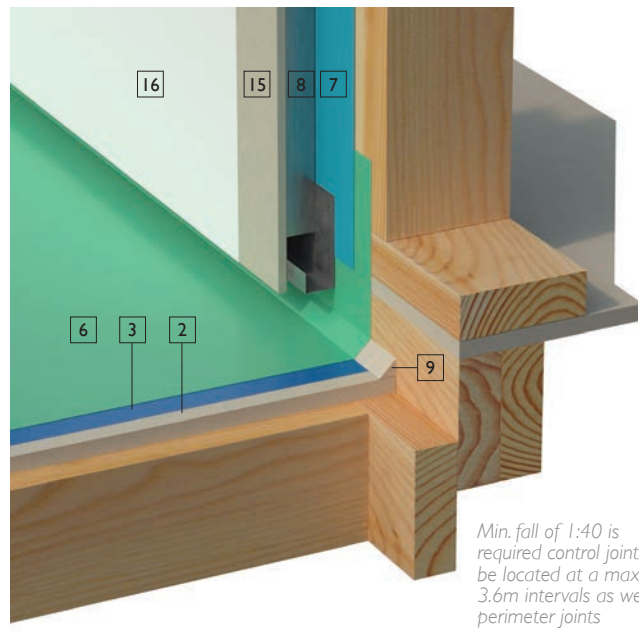

Figure 11
Waterproof without mortar bed - Exterior deck

- 1. KalsiFloor
- 2. Primer
- 3. Waterproof membrane
- 4. Tile adhesive
- 5. Min. 30mm thick mortar bed reinforced with galvanised wire mesh 50 x 50 x 2.5mm

- 6. Flashing
- 7. Building underlay
- 8. Cavity batten
- 9. Backing rod
- 10. Bond breaker tape
- 11. Timber flashing
- 12. Tiles

- 13. Marble tiles
- 14. Timber flooring
- 15. External cladding
- 16. Coating
- 17. Acetic based sealant

Installation details

Screws

Self tapping screws (with self drilling head) to fix into purlins (requires pre-drill if steel profile is too thick)

Minimum 8G x 40mm length for decking (based on profile thickness).

Should be galvanised or non-corrosive for long term durability use.

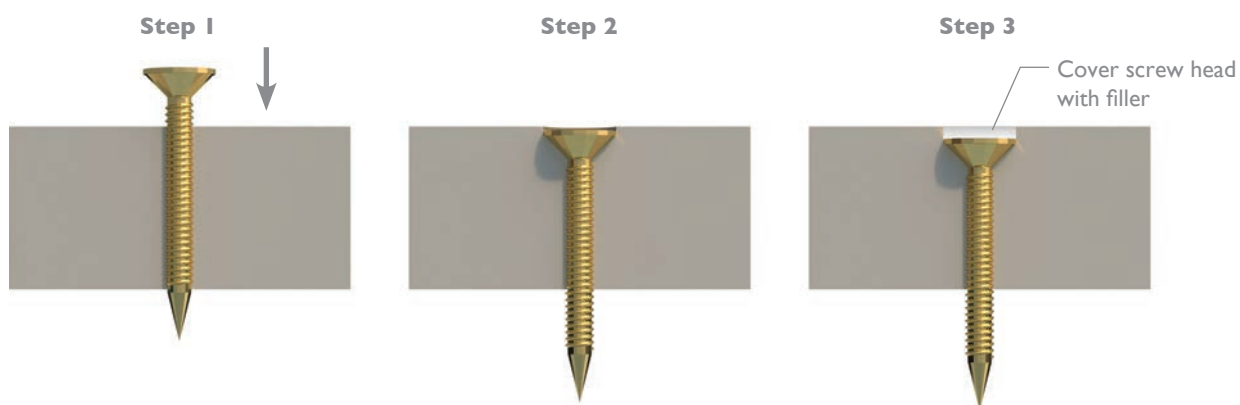

Figure 12
Fixing steps

Screw to be covered up with filler before coating over it for aesthetic purposes and better protection against water ingress through screw points.

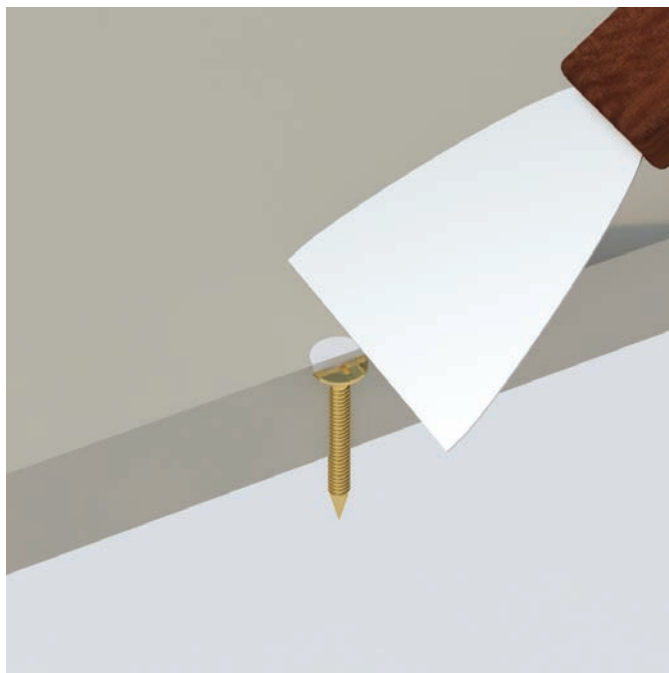

Figure 13
Sealing over fasteners (wet areas only)

Installation details

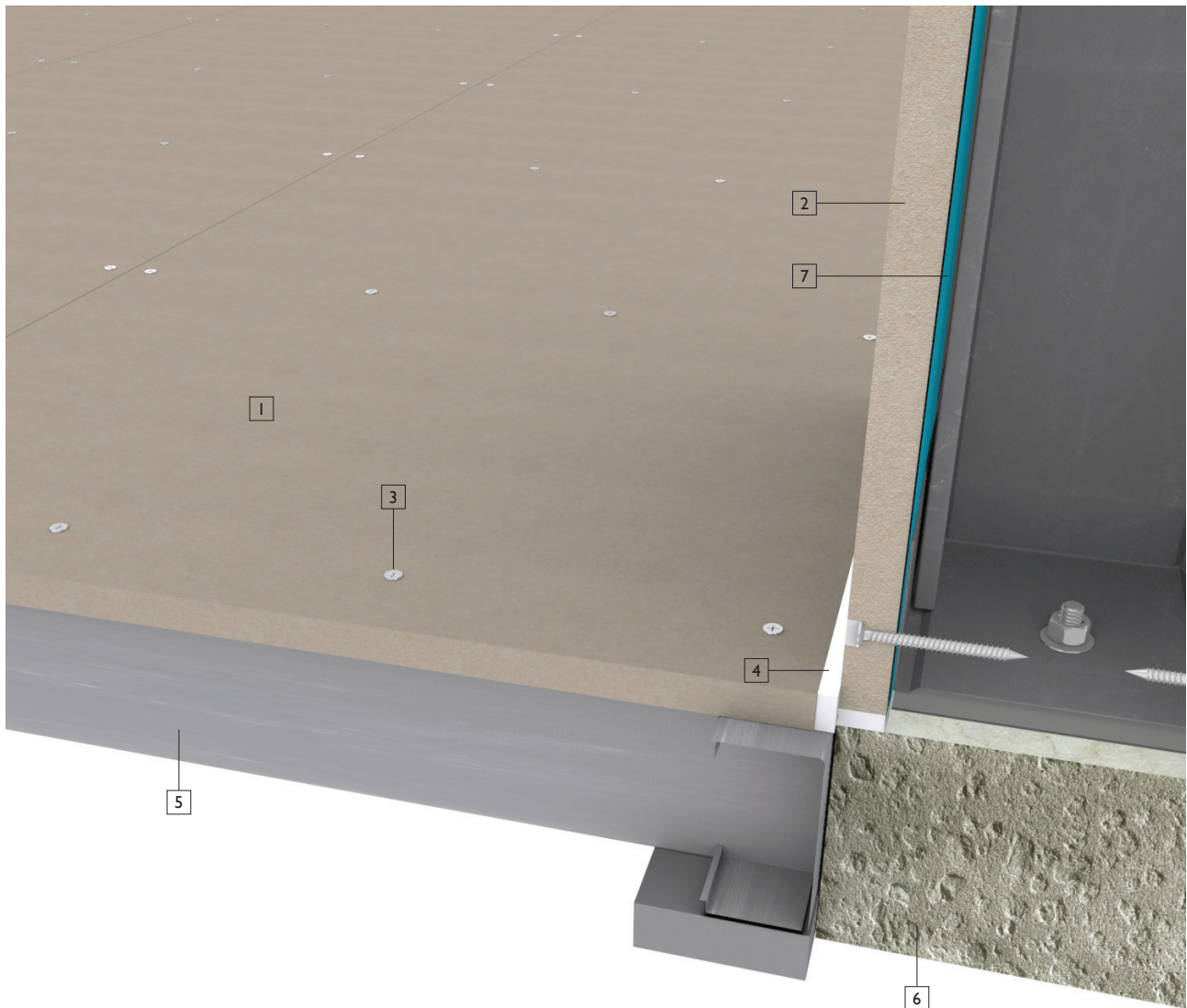

Figure 14
Wall and floor joint

- | | | |
|------------------|-------------------------|---|
| 1. KalsiFloor | 4. Polyurethane sealant | 7. Vapour permeable membrane
(if required) |
| 2. Wall cladding | 5. Steel framing | |
| 3. Screw | 6. Concrete wall | |

Finishing

Based on the room function which correlates to its final structure load, such as dead load and live load to be endured by the floor; note that usage of topcoat, carpet, vinyl and parquet finishing is suggested only for minimal load spaces utilisation such as residential, office or low traffic application.

In case of heavy-duty load area, high performance epoxy coatings to be used for wearing resistance etc.

KalsiFloor surface is generally **NOT RECOMMENDED** to be left exposed and must be covered accordingly with suitable finishing material for assurance in durability and long-lasting desirable aesthetic.

The material itself can tolerate being installed raw/ uncoated as it passes all the weathering and aging tests such as Heat-Rain, Soak-Dry, Warm Water and Freeze-Thaw cycles, however, kindly be advised that it **WILL NOT BE** aesthetically pleasing and could result in permanent damage after prolonged exposure.

Note (Internal Or Semi-External Application ONLY):

If it is to be installed raw, it is at the customer's own consent upon clarifying the risks involved as some project or application has no concern over aesthetic and solely aims for functional need such as backer board, under roofing and etc. There should still be basic consideration in terms of protecting the board from any permanent water ponding condition or extreme (unusually high) exposure.



Painting/ Top Coats

Depending on the level of exposure (interior or exterior), it is advisable to seek paint vendor/ manufacturer on recommendations that take into consideration the following:

- 1) Natural weathering agents such as rain, sun (UV)
- 2) Desired appearance like colour and gloss level (matte, semi-glossy, glossy)
- 3) Other specification like abrasion/ impact/ scratch resistance, anti-skid, chemical resistance etc

General recommendation is applying a minimum 2 layer of quality water-based acrylic coating on top face.

Coatings should be of vapour permeable type.

Other types of coat such as Polyurethane or Epoxy based coating is suitable as well but may require special preparation.

Note to follow instructions or recommendations of the manufacturer of paints/ coating on methods of application and maintenance in order to obtain the best possible installation.

Immediately after installation, boards are supposed to be coated within **90 days** in an external environment.

Ensure the boards are dry, free from dust, grease and other contaminants before applying the coating. Consider sanding if smoother surface is required.

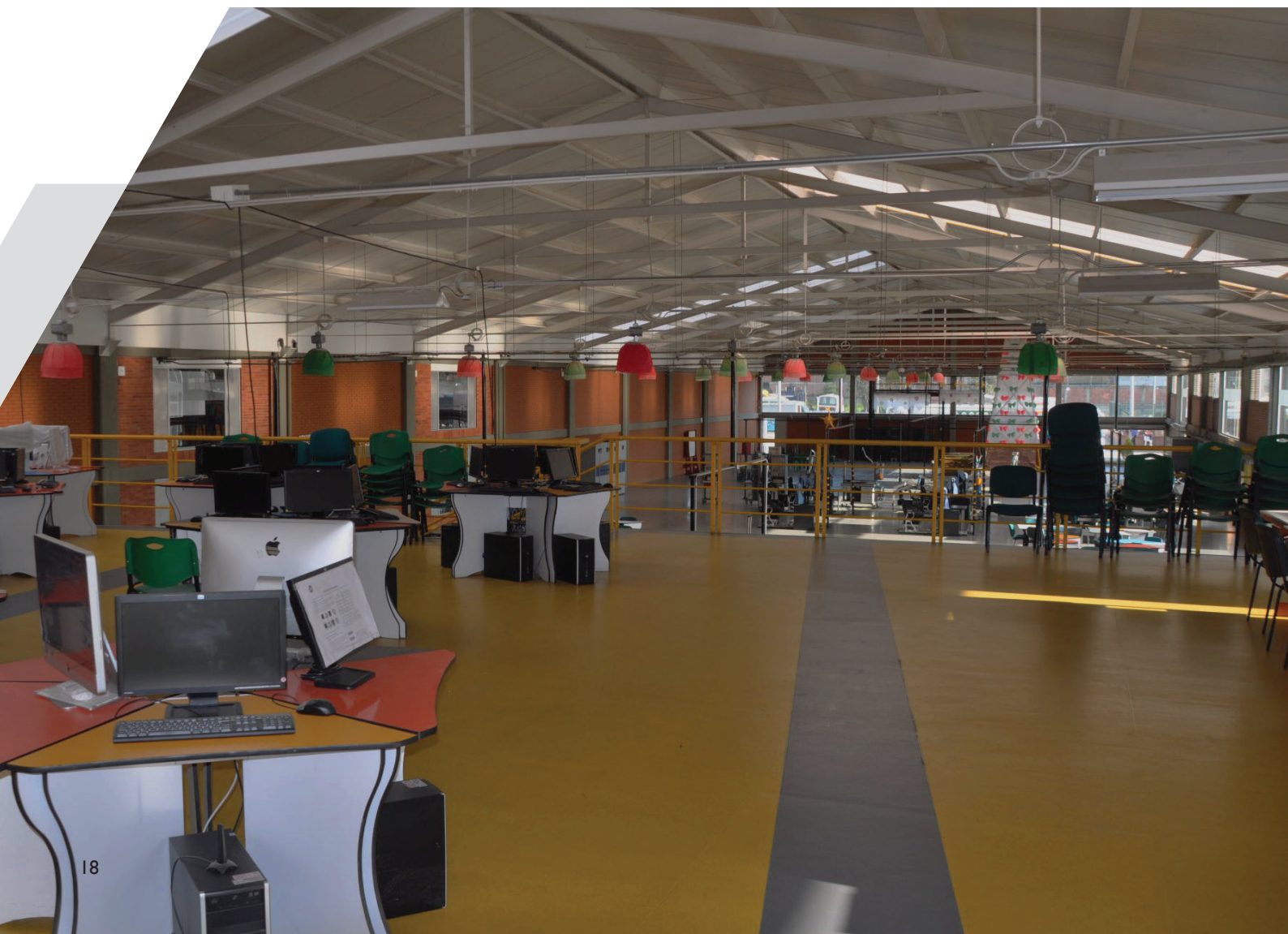



New Zealand Distributor:



Independent Building Supplies Ltd

1/7 Fraser Road, Panmure, Auckland, 1072

☎ +64 0800 367 759

☎ +64 0800 500 549

✉ info@ibs.co.nz

Promat Australia Pty Ltd

1 Scotland Road, SA 5031 Mile End South

☎ 1800 Promat (776 628)

☎ +61 8 8352 1014

✉ PAPL.mail@etexgroup.com

www.kalsi-building-solutions.com



KalsiFloor

Installation Guide

Disclaimer:

The sole purpose of images, references and recommendations in this document is to illustrate the functionality and versatility of the products and solutions from Kalsi and the proven international expertise of Etex Group. Note that the successful performance of the product & solutions depends on numerous factors outside Etex Building Performance Indonesia's control (quality of workmanship, design, handling and storage procedures, etc.)