



Austrian Institute of Construction Engineering  
Schenkenstrasse 4 | T+43 1 533 65 50  
1010 Vienna | Austria | F+43 1 533 64 23  
www.oib.or.at | mail@oib.or.at



# European Technical Assessment

## ETA-16/0309 of 01.09.2016

General part

**Technical Assessment Body issuing the European Technical Assessment**

Österreichisches Institut für Bautechnik (OIB)  
Austrian Institute of Construction Engineering

**Trade name of the construction product**

PROMASEAL®-AG

**Product family to which the construction product belongs**

Fire Stopping and Fire Sealing Product:  
Penetration seal

**Manufacturer**

Promat International NV  
Bormstraat 24  
2830 Tiselt  
Belgium

**Manufacturing plant**

Production plant 12

**This European Technical Assessment contains**

34 pages including Annexes 1 to 3 which form an integral part of this assessment

**This European Technical Assessment is issued in accordance with Regulation (EU) No 305/2011, on the basis of**

Guideline for European technical approval (ETAG) No. 026-2 Fire Stopping and Fire Sealing Products – Part 2: Penetration Seals, edition August 2011, used as European Assessment Document (EAD)

TERVEZÉSI SZIGELLET

## **General part**

This European Technical Assessment is not to be transferred to manufacturers or agents of manufacturer other than those indicated on page 1, or manufacturing plants other than those laid down in the context of this European Technical Assessment.

Translations of this European Technical Assessment in other languages shall fully correspond to the original issued document and should be identified as such.

Communication of this European Technical Assessment, including transmission by electronic means, shall be in full. However, partial reproduction can be made with the written consent of the Österreichisches Institut für Bautechnik. In this case, partial reproduction has to be designated as such.

This European Technical Assessment may be withdrawn by the Österreichisches Institut für Bautechnik, in particular pursuant to information by the Commission according to Article 25 (3) of Regulation (EU) No 305/2011.

## **Specific parts**

### **1. Technical description of the product**

#### **1.1 Definition of the construction product**

The firestop product PROMASEAL®-AG is an intumescent acrylic based sealant to form a penetration seal to reinstate the fire resistance performance of floor and wall constructions, where they have been provided with apertures for the penetration of different installations.

Type of penetration seal PROMASEAL®-AG: Sealants/Mastics.

The colour of firestop sealant PROMASEAL®-AG: grey.

A detailed specification of the product PROMASEAL®-AG is a non-public part of this European Technical Assessment, and deposited at the Österreichisches Institut für Bautechnik.

### **2. Specification of the intended use(s) in accordance with the applicable European Assessment Document (hereinafter EAD)**

#### **2.1 Intended use**

The intended use of PROMASEAL®-AG firestop sealant is to reinstate the fire resistance performance of flexible wall, rigid wall and rigid floor constructions where they are penetrated by different installations.

In the following specified constructions PROMASEAL®-AG is also used in conjunction with non-combustible mineral wool as backfilling material, if applicable.

- (1) The specific elements of construction that PROMASEAL®-AG may be used to provide a penetration seal in, are as follows (details see Annex 3):
  - A) Flexible walls: The wall must have a minimum thickness of 100 mm and comprise timber or steel studs lined on both faces with minimum 2 layers of minimum 12,5 mm thick boards. For timber stud walls there must be a minimum distance of 100 mm of the seal to any stud and the cavity between stud and seal must be closed and minimum 100 mm insulation of class A1 or A2 (in accordance with EN 13501-1) in the cavity between stud and seal.
  - B) Rigid walls: The wall must have a minimum thickness of 100 mm and consist of concrete, aerated concrete or masonry, with a minimum density of 450 kg/m<sup>3</sup>.
  - C) Rigid floors: The floor must have a minimum thickness of 150 mm and consist of aerated concrete or concrete with a minimum density of 650 kg/m<sup>3</sup>.

This ETA does not cover the use of this product as a penetration seal in sandwich panel constructions.

- (2) PROMASEAL®-AG may be used as a penetration seal with the following specific installations or as blank seal:
  - Cables: For further details see Annex 3.
  - Cable bundles: For further details see Annex 3.
  - Plastic pipes: For further details see Annex 3.
  - Metal pipes: For further details see Annex 3.
 The maximum seal sizes in the different compartments (see 2.1.) see Annex 3 of the ETA.

- (3) Distances:

Specimen	Minimum distance (mm)
Cable, cable bundle – Aperture opening	0
Cable – Cable	0
Conduits – Aperture opening	20
Conduits – Conduits	0
Non-combustible insulations – Aperture opening	10
Non-combustible insulations – Non-combustible insulations	0
Plastic pipes – Aperture opening	20

Between all other installations: minimum 100 mm - for further details see Annex 3.

- (4) Supporting distance on both faces of wall constructions: ≤ 250 mm  
 Supporting distance on the upper face of floor constructions: ≤ 250 mm

## 2.2 Use category

The use category of PROMASEAL®-AG is Type Y<sub>1</sub>. Since the requirements for Y<sub>1</sub> are met, also the requirements for type Z<sub>1</sub>, Z<sub>2</sub> and Y<sub>2</sub> are fulfilled.

- Type Y<sub>1</sub>: Products intended for use at temperatures between -20°C and + 70°C, with exposure to UV but no exposure to rain.
- Type Y<sub>2</sub>: Products intended for use at temperatures between -20°C and + 70°C, with no exposure to UV nor rain.
- Type Z<sub>1</sub>: Products intended for use at internal conditions with high humidity, excluding temperatures below 0°C<sup>1</sup>, without exposure to rain or UV.
- Type Z<sub>2</sub>: Products intended for use at internal conditions with humidity classes other than Z<sub>1</sub>, excluding temperatures below 0°C, without exposure to rain or UV.

<sup>1</sup> These uses apply for internal humidity class 5 in acc. with EN ISO 13788

### 2.3 General assumptions

It is assumed that

- a) damages to the penetration seal are repaired accordingly,
- b) the installation of the penetration seal does not effect the stability of the adjacent building element – even in case of fire,
- c) the lintel or floor above the penetration seal is designed structurally and in terms of fire protection such that no additional mechanical load (other than its own weight) is imposed on the penetration seal,
- d) the aperture lining within a flexible wall is supported by the studs (transoms and mullions) in such a way that the mechanical load imposed to the aperture lining by the penetration seal does not affect the stability of the aperture lining and the flexible wall,
- e) the thermal movement in the pipe work will be accommodated in such way that it does not impose a load on the penetration seal,
- f) the installations are fixed to the adjacent building element in accordance with the relevant regulations in such a way that, in case of fire, no additional mechanical load is imposed to the penetration seal,
- g) the support of the installations is maintained for the required period of fire resistance and
- h) Pneumatic dispatch systems, compressed air systems, etc. are switched off by additional means in case of fire (for sealing off plastic composite pipes).

This European Technical Assessment does not address any risks associated with the emission of dangerous liquids or gases caused by failure of the pipe(s) in case of fire nor does it prove the prevention of the transmission of fire through heat transfer via the medium in the pipes.

This European Technical Assessment does not verify the prevention of destruction of adjacent building elements with fire separating function or of the pipes themselves due to distortion forces caused by extreme temperatures. These risks shall be accounted for by taking appropriate measures when designing or installing the pipe work.

The mounting or hanging of the cables/pipes or the layout of the pipe work shall be implemented in such a way that the cables/pipes and the fire resistant building elements shall remain functional within a period of time which corresponds to the fire resistance period required.

The risk of downward spread of fire caused by burning material which drips through a pipe to floors below is not considered in this European Technical Assessment.

The durability assessment does not take account of the possible effect on the penetration seal of substances permeating through the pipe walls.

The assessment does not cover the avoidance of destruction of the penetration seal or of the adjacent building element(s) by forces caused by temperature changes in case of fire. This has to be considered when designing the piping system.

### 2.4 Manufacturing

The European Technical Assessment is issued for the product on the basis of agreed data/information, deposited with the Österreichisches Institut für Bautechnik, which identifies the product that has been assessed and judged. Changes to the product or production process, which could result in this deposited data/information being incorrect, should be notified to the Österreichisches Institut für Bautechnik before the changes are introduced. The Österreichisches Institut für Bautechnik will decide whether or not such changes affect the European Technical Assessment and consequently the validity of the CE marking on the basis of the European Technical Assessment and if so whether further assessment or alterations to the European Technical Assessment, shall be necessary.

## 2.5 Installation

The product shall be installed and used as described in this European Technical Assessment and in accordance to the product data sheet of PROMASEAL®-AG. Additional marking of the penetration seal shall be done in case of national requirements.

The arrangement and installation of PROMASEAL®-AG shall be done in accordance with the details given here and in Annex 2 and 3 for the penetration seal(s).

The installation of PROMASEAL®-AG should be conducted according to the installation manuals as follows:

- Compare the installations with the installations manual if the type is sealable
- Application temperatures should be between +5°C to +40°C.
- Cleaning the opening, surface to which PROMASEAL®-AG will be applied, should be cleaned of oil, wax, dirt, loose debris, grease and dust.
- For very porous substrates the surface should be prewetted with water. PROMASEAL®-AG adheres to the most substrates (plaster, drywall, concrete...) without using a special primer.
- Insert backfilling material and leave a defined gap depth for application of PROMASEAL®-AG.
- Apply PROMASEAL®-AG using a dispenser.
- For smoothing the sealant a spatula or the finger may be used and it is also possible to use a bit of water to support smoothing.
- The used tools may be cleaned with water.

## 3. Performance of the product and references to the methods used for its assessment

Basic requirements for construction works	Essential characteristics	Method of verification	Performance
<b>BWR 2</b>	Reaction to fire	EN 13501-1:2007+A1:2009	See 3.1.1
	Resistance to fire	EN 13501-2:2007+A1:2009	See 3.1.2 and Annex 3
<b>BWR 3</b>	Content and/or release of dangerous substances	European Council Directive 7/548/EEC-Dangerous Substances Directive and Regulation (EC) No 1272/2008	Declaration of conformity by the manufacturer
<b>BWR 7</b>	No Performance Assessed		

### 3.1 Safety in case of fire (BWR 2)

#### 3.1.1 Reaction to fire

The components of construction product PROMASEAL®-AG were assessed according to ETAG 026-Part 2 used as EAD clause 2.4.1 and classified according to EN 13501-1:2007+A1:2009.

Component	Class according to EN 13501-1
PROMASEAL®-AG intumescent firestop sealant	E

### 3.1.2 Resistance to fire

PROMASEAL®-AG has been tested in accordance with EN 1366-3:2009 installed within apertures in flexible walls, rigid walls and rigid floors. For more details of installations see clause 2.1 and Annex 3 of the ETA.

The apertures were penetrated by different installations listed in Annex 3 of the ETA.

As shown in Annex 3, the test results and the direct field of application (acc. to EN 1366-3:2009) PROMASEAL®-AG has been classified in accordance with EN 13501-2:2007+A1:2009.

The seals may only be penetrated by the services described in Annex 3. Other parts must not penetrate the seal.

Appropriate wall and floor constructions for penetration seals see clause 2.1.

The service support construction must be fixed to the building element containing the penetration seal or a suitable adjacent building element, on both sides of the penetration in such a manner that in the case of fire, no additional load is imposed on the seal. Furthermore it is assumed that this support is maintained on the unexposed side, for the required period of fire resistance.

Information on ancillary products, which were tested within the framework of this European Technical Assessment for evaluating resistance to fire, is given in Annex 2.

Specific considerations:

- Plastic pipes must be perpendicular to the seal surface.
- It is assumed that compressed air systems are switched off by other means in the case of fire.
- The function of the pipe seal in case of pneumatic dispatch systems, pressurised air systems etc. is guaranteed only when the systems are shut off in case of fire.
- The assessment does not address any risks associated with leakage of dangerous liquids or gases caused by failure of the pipe(s) in case of fire.
- The durability assessment does not take account of the possible effect of substances permeating through the pipe on the penetration seal.
- The classifications relate to U/C (uncapped inside the furnace/capped outside).
- The risk of spread of fire downwards caused by burning material, which drips through a pipe downwards to floors below, cannot be assessed with tests according to EN 1366-3 and is therefore not part of the assessment of this ETA.

## 3.2 Hygiene, health and environment (BWR 3)

### 3.2.1 Release of dangerous substances

According to the manufacturer's declaration "PROMASEAL®-AG" does not contain dangerous substances detailed in Council Directive 67/548/EEC and Regulation (EC) no 1272/2008 as well as EOTA TR 034 (General ER 3 Checklist for ETAGs/CUAPs/ETAs- Content and/or release of dangerous substances in products/kits), edition March 2012.

A written declaration in this respect was submitted by the ETA-holder.

In addition to the specific clauses relating to dangerous substances contained in this European Technical Assessment, there may be other requirements applicable to the products falling within its scope (e.g. transposed European legislation and national laws, regulations and administrative provisions). In order to meet the provisions of the Construction Products Regulation, these requirements need also to be complied with, when and where they apply.

## 3.6 Sustainable use of natural resources (BWR 7)

No performance assessed.

### **3.7 General aspects relating to fitness for use**

#### **3.7.1 Durability**

PROMASEAL®-AG has been tested in accordance to EOTA TR 024, Table 4.2.4 for the Y<sub>1</sub> use category specified in EOTA ETAG 026-2 and the results of the test have demonstrated suitability for penetration seals intended for use at temperatures between -20°C und +70°C with exposure to UV but without exposure to rain.

## **4 Assessment and verification of constancy of performance (hereinafter AVCP) system applied, with reference to its legal base**

### **4.1 AVCP system**

According to the Decision 1999/454/EC<sup>2</sup>, amended by Decision 2001/596/EC<sup>3</sup> of the European Commission, as amended, the system(s) of assessment and verification of constancy of performance (see Annex V of Regulation (EU) No 305/2011) is 1.

## **5 Technical details necessary for the implementation of the AVCP system, as provided for in the applicable EAD**

### **5.1 Tasks of the manufacturer**

#### **5.1.1 Factory production control**

The manufacturer shall exercise permanent internal control of production. All the elements, requirements and provisions adopted by the manufacturer shall be documented in a systematic manner in the form of written policies and procedures, including records of results performed. This production control system shall insure that the product is in conformity with this European Technical Assessment.

The manufacturer may only use initial/raw/constituent materials stated in the Technical documentation<sup>4</sup> of this European Technical Assessment

For the components, which the ETA-holder does not manufacture by himself, he shall make sure that factory production control carried out by the other manufacturers gives the guarantee of the components compliance with the European Technical Assessment.

The factory production control and the provisions taken by the ETA-holder for components not produced by himself shall be in accordance with the control plan<sup>5</sup> relating to this European Technical Assessment, which is a confidential part of the Technical documentation of this European Technical Assessment.

The results and details of the extent, nature and frequency of controls be performed within the factory production control shall be recorded and evaluated in accordance with the provisions of the control plan.

#### **5.1.2 Other tasks of the manufacturer**

The manufacturer shall provide a Technical data sheet and an installation instruction with the

<sup>2</sup> Official Journal of the European Communities no. L 178, 14.7.1999, p. 52

<sup>3</sup> Official Journal of the European Communities no. L 209, 2.8.2001, p. 33

<sup>4</sup> The technical documentation of this European Technical Assessment has been deposited at the Österreichisches Institut für Bautechnik and, as far as relevant for the tasks of the notified product certification body involved in the assessment and verification of constancy of performance, is handed over to the notified product certification body.

<sup>5</sup> The control plan has been deposited at Österreichisches Institut für Bautechnik and is handed over only to the notified product certification body involved in the assessment and verification of constancy of performance.

following minimum information:

Technical data sheet:

- a) Field of application:
  - 1) Building elements for which the penetration seal is suitable, type and properties of the building elements like minimum thickness, density, and – in case of lightweight constructions – the construction requirements
  - 2) Services which may pass through the penetration seal, type and properties of the services like material, diameter, thickness etc. in case of pipes including insulation materials; necessary/allowed supports/fixings
  - 3) Limits in size, minimum thickness etc. of the penetration seal
  - 4) Environmental conditions covered by this European Technical Assessment
- b) Construction of the penetration seal including the necessary components and additional products (e.g. backfilling material) with clear indication whether they are generic or specific.

Installation instruction:

- a) Steps to be followed
- b) Stipulations on maintenance, repair and replacement

The manufacturer shall, based on a contract, involve a notified product certification body, which is notified for the tasks referred to in clause 4.1 of the ETA in the field of Assessment product. For this purpose, the control plan referred to in clause 5.1 and 5.2 of the ETA shall be handed over by the manufacturer to the notified product certification body involved.

The manufacturer shall make a declaration of conformity, stating that the construction product is in conformity with the provisions of this European Technical Assessment.

5.1.3 Further testing of samples taken at the factory

Testing of samples taken at the factory by the manufacturer is not required.

**5.2 Tasks of notified product certification body**

The notified product certification body shall retain the essential points of its actions referred to clause 5.2.1 to 5.2.3, state the results obtained and conclusions drawn in written report.

These tasks shall be performed in accordance with the provisions laid down in the control plan of this European Technical Assessment.

5.2.1 Determination of the product type

Notified product certification bodies undertaking tasks under Systems 1 shall consider the European Technical Assessment issued for the construction product in question as the assessment of the performance of that product. Notified bodies shall therefore not undertake the tasks referred to in point 1.2 (b)(i), in Annex V of Regulation (EU) No 305/2011, unless there are changes in the manufacture or manufacturing plant. In such cases, the necessary initial type testing has to be agreed between the Österreichisches Institut für Bautechnik and notified product certification body involved.



5.2.2 Initial inspection of the manufacturing plant and of factory production control

The notified product certification body shall ascertain that, in accordance with the control plan, the manufacturing plant, in particular personnel and equipment, and the factory production control are suitable to ensure a continuous and orderly manufacturing of the kit according to the specifications given in clause 2 and in the Annexes of the European Technical Assessment.

5.2.3 Continuous surveillance, assessment and evaluation of factory production control

The notified product certification body shall visit the factory at least once a year for surveillance of the manufacturer.

It has to be verified that the system of factory production control and the specified manufacturing process are maintained taking into account the control plan.

Continuous surveillance and assessment of factory production control have to be performed according to the control plan.

The results of continuous surveillance shall be made available on demand by the notified product certification body or the Österreichisches Institut für Bautechnik. In cases where the provisions of the European Technical Assessment and the control plan are no longer fulfilled, the certificate of constancy of performance shall be withdrawn.

Issued in Vienna on 01.09.2016  
by Österreichisches Institut für Bautechnik

Rainer Mikulits  
Managing Director

TERVEZÉSI

## ANNEX 1

### Reference documents and list of abbreviations

#### 1.1 Reference to standards mentioned in this ETA:

ETAG 026-2 (2011)	Fire stopping and fire sealing products - Part 2: Penetration Seals
EN 13501-1:2007+A1:2009	Fire classification of construction products and building elements - Part 1: Classification using test data from reaction to fire tests
EN 13501-2:2007+A1:2009	Fire classification of construction products and building elements - Part 2: Classification using data from fire resistance tests, excluding ventilation
EN 1363-1:1999	Fire resistance tests - Part 1: General requirements
EN 1366-3:2009	Fire resistance tests for service installations - Part 3: Penetration seals

#### 1.2 Other reference documents:

EOTA TR 024 (2009)	Characterisation, Aspects of Durability and Factory Production Control for Reactive Materials, Components and Products
--------------------	--

TERVEZÉSI SZIGELLET

## ANNEX 2

### DESCRIPTION OF PRODUCT(S) & PRODUCT LITERATURE

#### 2.1 Product:

Product name	Description
PROMASEAL®-AG	Intumescent firestop sealant

Suitable insulation products – reaction to fire	
Non-combustible insulation (mineral wool)	A1 (acc. to EN 13501-1), melting point $\geq 1000$ °C

For backfilling mineral wool with a melting point  $\geq 1000$  °C and a classification to A1 in accordance to EN 13501-1.

#### 2.2 Technical product literature:

- Product data sheet of PROMASEAL®-AG
- Installation manual of PROMASEAL®-AG
- Detailed sketches for PROMASEAL®-AG

TERVEZÉSI SEGÉDLET

**ANNEX 3**  
**RESISTANCE TO FIRE CLASSIFICATION OF PROMASEAL®-AG**

**3.1 Classification acc. to EN 13501-2 for the PROMASEAL®-AG firestop sealant**

Seal sizes in dependence with the supporting construction (see ETA 2.1):

Supporting construction	PROMASEAL®-AG
Flexible walls	≤ 0,03 m <sup>2</sup>
Rigid walls	≤ 0,03 m <sup>2</sup>
Rigid floors	≤ 0,03 m <sup>2</sup>

Classification of the PROMASEAL®-AG intumescent firestop sealant used as blank seal in dependence with the supporting construction (see ETA 2.1):

Supporting construction	Classification
Flexible walls	
- Sealant (thickness 15 mm) on the exposed side	E 120 / EI 90
- Sealant (thickness 15 mm) on the unexposed side	EI 120
- Sealant (thickness 15 mm) applied one-sided	E 120 / EI 90
Rigid walls	
- Sealant (thickness 15 mm) on the exposed side	E 120 / EI 90
- Sealant (thickness 15 mm) on the unexposed side	EI 120
- Sealant (thickness 15 mm) applied one-sided	E 120 / EI 90
Rigid floors	
- Sealant (thickness 15 mm) on the top side	EI 120
- Sealant (thickness 15 mm) on the bottom side	EI 120
- Sealant (thickness 15 mm) applied one-sided	EI 120

Installations may penetrate the penetration seal (details are given in the specific parts in Annex 3):

Specimen
Plastic pipes made of PVC and PP
Metal pipes (with insulations) made of steel, copper, cast iron, Ni-alloys
Cables and cable bundles (sheathed and non-sheathed)
Plastic conduits (with or without cables / cable bundles (sheathed and non-sheathed))

Supporting distances:

Orientation	Maximum distance (mm)
Distance on both faces of wall constructions	250
Distance on the upper face of floor constructions	250

Pipe end configurations:

Tested and classified for metal pipes	Applicable
U/C	C/U, U/C, C/C

### 3.2 Classification acc. to EN 13501-2 for the PROMASEAL®-AG firestop sealant for cables, cable bundles and conduits

*All sheathed cable:*

All sheathed cable types currently and commonly used in building practice in Europe (e.g. control, power, data, optical fibre cables, signal and telecommunication).

*All non-sheathed cable:*

All non-sheathed cables (wires) currently and commonly used in building practice in Europe.

*Tied cable bundle:*

Tied cable bundle (maximum diameter 100 mm), maximum diameter of single cable 21 mm.

*Conduits and conduit bundle:*

Maximum diameter of single conduits 50 mm, bundle maximum 5 pieces. Conduits with or without cables with a maximum diameter of 21 mm.

*PROMASEAL®-AG for gussets:*

The intumescent firestop sealant PROMASEAL®-AG shall be used on the surface cable gussets if smoke tightness is needed. For sealing gussets between conduits, PROMASEAL®-AG shall be used anytime.

*Classification in conjunction of the compartment:*

#### Classification in flexible and rigid wall constructions

PROMASEAL®-AG shall be applied as written in the table below. Use mineral wool (A1 in accordance to EN 13501-1 with melting point  $\geq 1000$  °C, see also Annex 2, clause 2.1) as backfilling material.

Name	Dimension scope Ø...Diameter (mm)	Position of PROMASEAL®-AG	Annular gap Width x depth (mm)	Classification
Cable bundle (single cables $\varnothing \leq 21$ mm, CYKY 4Bx6 or equal products, max. 36 pieces)	$\varnothing \leq 100$	Unexposed side	25 x 20	<b>EI 120</b>
Cable bundle (single cables $\varnothing \leq 21$ mm, CYKY 4Bx6 or equal products, max. 36 pieces)	$\varnothing \leq 100$	Two-sided (Backfilling Polystyrene or higher rated)	25 x 15	<b>E 120</b> <b>EI 90</b>
Cable bundle, all sheathed cable types, Cable group 1 (single cables $\varnothing \leq 21$ mm)	$\varnothing \leq 100$	Unexposed side	20 x 15	<b>E 120</b> <b>EI 90</b>
Cable bundle, all sheathed cable types, Cable group 1 (single cables $\varnothing \leq 21$ mm)	$\varnothing \leq 100$	Exposed side	20 x 15	<b>E 120</b> <b>EI 60</b>
Cable bundle, all sheathed cable types, Cable group 1 (single cables $\varnothing \leq 21$ mm)	$\varnothing \leq 100$	One-sided	20 x 15	<b>E 120</b> <b>EI 60</b>
All sheathed cable types, Cable group 2	$21 \leq \varnothing \leq 50$	One-sided	20 x 15	<b>E 120</b> <b>EI 60</b>
All sheathed cable types, Cable group 3	$50 \leq \varnothing \leq 80$	One-sided	20 x 15	<b>EI 60</b>
All sheathed cable types, Cable group 3	$50 \leq \varnothing \leq 80$	Unexposed side	20 x 15	<b>E 120</b> <b>EI 60</b>
Cable bundle, all sheathed cable types, Cable group 4 (single cables $\varnothing \leq 21$ mm)	$\varnothing \leq 100$	Exposed side	20 x 15	<b>E 120</b> <b>EI 60</b>

Name	Dimension scope Ø...Diameter (mm)	Position of PROMASEAL®-AG	Annular gap Width x depth (mm)	Classification
Cable bundle, all sheathed cable types, Cable group 4 (single cables Ø ≤ 21 mm)	Ø ≤ 100	Unexposed side	20 x 15	<b>EI 120</b>
Cable bundle, all sheathed cable types, Cable group 4 (single cables Ø ≤ 21 mm)	Ø ≤ 100	One-sided	20 x 15	<b>E 120 EI 60</b>
Flexible conduits acc. to EN 61386-21 and EN 61386-22 (tested U/C, with or without cables Ø ≤ 21 mm)	Ø ≤ 50	Two-sided	20 x 25	<b>EI 120-U/C</b>
Bundle of flexible conduits acc. to EN 61386-21 and EN 61386-22 (tested U/C, with or without cables Ø ≤ 21 mm)	Ø ≤ 5 x 50	Two-sided	20 x 25	<b>EI 120-U/C</b>

#### Classification in rigid floor constructions

PROMASEAL®-AG shall be applied as written in the table below. Use mineral wool (A1 in accordance to EN 13501-1 with melting point ≥ 1000 °C, see also Annex 2, clause 2.1) as backfilling material.

Name	Dimension scope Ø...Diameter (mm)	Position of PROMASEAL®-AG	Annular gap Width x depth (mm)	Classification
Cable bundle (single cables Ø ≤ 21 mm, CYKY 4Bx6 or equal products, max. 36 pieces)	Ø ≤ 100	Upper side	25 x 20	<b>EI 120</b>
Cable bundle (single cables Ø ≤ 21 mm, CYKY 4Bx6 or equal products, max. 36 pieces)	Ø ≤ 100	Upper and bottom side (Backfilling Polystyrene or higher rated)	25 x 15	<b>EI 120</b>
Cable bundle, all sheathed cable types, Cable group 1 (single cables Ø ≤ 21 mm)	Ø ≤ 100	Upper side	20 x 15	<b>E 120 EI 60</b>
Cable bundle, all sheathed cable types, Cable group 1 (single cables Ø ≤ 21 mm)	Ø ≤ 100	Bottom side	20 x 15	<b>E 120 EI 60</b>
Cable bundle, all sheathed cable types, Cable group 1 (single cables Ø ≤ 21 mm)	Ø ≤ 100	One-sided	20 x 15	<b>E 120 EI 60</b>
All sheathed cable types, Cable group 2	21 ≤ Ø ≤ 50	One-sided	20 x 15	<b>E 120 EI 60</b>
All sheathed cable types, Cable group 3	50 ≤ Ø ≤ 80	Bottom side	20 x 15	<b>E 90 EI 60</b>
All sheathed cable types, Cable group 3	50 ≤ Ø ≤ 80	Upper side	20 x 15	<b>EI 120</b>
Cable bundle, all sheathed cable types, Cable group 4 (single cables Ø ≤ 21 mm)	Ø ≤ 100	Upper side	20 x 15	<b>E 120 EI 60</b>
Cable bundle, all sheathed cable types, Cable group 4 (single cables Ø ≤ 21 mm)	Ø ≤ 100	Bottom side	20 x 15	<b>E 120 EI 60</b>
Cable bundle, all sheathed cable types, Cable group 4 (single cables Ø ≤ 21 mm)	Ø ≤ 100	One-sided	20 x 15	<b>E 120 EI 60</b>

Name	Dimension scope Ø...Diameter (mm)	Position of PROMASEAL®-AG	Annular gap Width x depth (mm)	Classification
Flexible conduits acc. to EN 61386-21 and EN 61386-22 (tested U/C, with or without cables Ø ≤ 21 mm)	Ø ≤ 50	Upper and bottom side	20 x 25	<b>EI 120-U/C</b>
Bundle of flexible conduits acc. to EN 61386-21 and EN 61386-22 (tested U/C, with or without cables Ø ≤ 21 mm)	Ø ≤ 5 x 50	Upper and bottom side	20 x 25	<b>EI 120-U/C</b>

### 3.3 Classification acc. to EN 13501-2 for the PROMASEAL®-AG firestop sealant for plastic pipes

Plastic pipes may penetrate the PROMASEAL®-AG penetration seal.

*Specification of the plastic pipes:* See section below.

#### Classification in flexible and rigid wall constructions

PROMASEAL®-AG shall be applied as written in the table below. Use mineral wool (A1 in accordance to EN 13501-1 with melting point ≥ 1000 °C, see also Annex 2, clause 2.1) as backfilling material.

Name	Dimension scope Ø...Diameter (mm) t <sub>D</sub> ...Pipe wall thickness (mm)	Position of PROMASEAL®-AG	Annular gap Width x depth (mm)	Classification
PVC-U pipe	Ø 110 / t <sub>D</sub> 3,2	Two-sided	20 x 25	<b>EI 120-U/C</b>
PP pipe	Ø 50 / t <sub>D</sub> 1,8	Two-sided	20 x 20	<b>EI 120-U/C</b>

The classifications for PVC pipes are applicable for pipes in acc. to EN 1452-2, DIN 8061 and DIN 8062. The classifications for PP pipes are applicable for pipes in acc. to EN ISO 15494, DIN 8077 and DIN 8078.

#### Classification in rigid floor constructions

PROMASEAL®-AG shall be applied as written in the table below. Use mineral wool (A1 in accordance to EN 13501-1 with melting point ≥ 1000 °C, see also Annex 2, clause 2.1) as backfilling material.

Name	Dimension scope Ø...Diameter (mm) t <sub>D</sub> ...Pipe wall thickness (mm)	Position of PROMASEAL®-AG	Annular gap Width x depth (mm)	Classification
PVC-U pipe	Ø 110 / t <sub>D</sub> 3,2	Upper and bottom side	20 x 25	<b>EI 120-U/C</b>
PP pipe	Ø 50 / t <sub>D</sub> 1,8	Upper and bottom side	20 x 20	<b>EI 120-U/C</b>

The classifications for PVC pipes are applicable for pipes in acc. to EN 1452-2, DIN 8061 and DIN 8062. The classifications for PP pipes are applicable for pipes in acc. to EN ISO 15494, DIN 8077 and DIN 8078.

### 3.4 Classification acc. to EN 13501-2 for the PROMASEAL®-AG firestop sealant for metal pipes with non-combustible insulation

Steel and copper pipes with non-combustible insulation may penetrate the PROMASEAL®-AG penetration seal.

*Specification of the non-combustible insulation:*  
See sections steel and copper below.

Metal pipes with non-combustible insulation according to following possibilities:

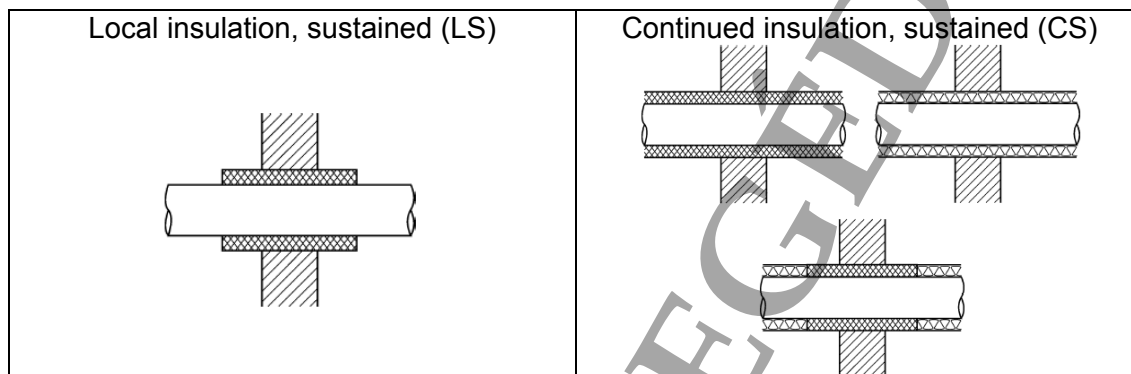

LS cover LS and CS.

#### Steel pipes

##### Classification in flexible and rigid wall constructions

Specification of insulation	Thresholds
Non-combustible insulation	Reaction to fire A2 <sub>L</sub> in accordance to EN 13501-1
Non-combustible insulation	Reaction to fire A1 in accordance to EN 13501-1 used for pipe diameter Ø 48/ t <sub>D</sub> 1 - 14,2
Insulation thickness	≥ 30 mm
Insulation density	≥ 40 kg/m <sup>3</sup>
Total insulation length	≥ 550 mm
Case of insulation	LS, CS

Name	Dimension scope Ø...Diameter (mm) t <sub>D</sub> ...Pipe wall thickness (mm)	Position of PROMASEAL®-AG	Annular gap Width x depth (mm)	Classification
Steel pipes with ins.	Ø 18 - 48 / t <sub>D</sub> 1 - 14,2	Two-sided	20 x 25	<b>EI 120-U/C</b>

The field of application given for metal pipes with lower heat conductivity ( $\lambda \leq 58$  W/mK) and a melting point of minimum 1100°C (e.g. stainless steel, cast iron, Ni alloys (NiCr, NiMo and NiCu alloys) and Ni.

##### Classification in rigid floor constructions

Specification of insulation	Thresholds
Non-combustible insulation	Reaction to fire A2 <sub>L</sub> in accordance to EN 13501-1
Non-combustible insulation	Reaction to fire A1 in accordance to EN 13501-1 used for pipe diameter Ø 48/ t <sub>D</sub> 1 - 14,2
Insulation thickness	≥ 30 mm
Insulation density	≥ 40 kg/m <sup>3</sup>
Total insulation length	≥ 550 mm
Case of insulation	LS, CS



Name	Dimension scope Ø...Diameter (mm) t <sub>D</sub> ...Pipe wall thickness (mm)	Position of PROMASEAL®-AG	Annular gap Width x depth (mm)	Classification
Steel pipes with ins.	Ø 18 - 48 / t <sub>D</sub> 1 - 14,2	Upper and bottom side	20 x 25	<b>EI 120-U/C</b>

The field of application given for metal pipes with lower heat conductivity ( $\lambda \leq 58$  W/mK) and a melting point of minimum 1100°C (e.g. stainless steel, cast iron, Ni alloys (NiCr, NiMo and NiCu alloys) and Ni.

## Copper pipes

### Classification in flexible and rigid wall constructions

Specification of insulation	Thresholds
Non-combustible insulation	Reaction to fire A1 in accordance to EN 13501-1
Insulation thickness	≥ 30 mm
Insulation density	≥ 40 kg/m <sup>3</sup>
Total insulation length	≥ 550 mm
Case of insulation	LS, CS

Name	Dimension scope Ø...Diameter (mm) t <sub>D</sub> ...Pipe wall thickness (mm)	Position of PROMASEAL®-AG	Annular gap Width x depth (mm)	Classification
Copper pipes with ins.	Ø 18 / t <sub>D</sub> 1 - 14,2	Two-sided	20 x 25	<b>EI 120-U/C</b>

The field of application given for copper pipes is also valid for other metal pipes with lower heat conductivity ( $\lambda \leq 380$  W/mK) and a melting point of minimum 1083 °C (e.g. stainless steel, cast iron, Ni alloys (NiCr, NiMo and NiCu alloys) and Ni.

### Classification in rigid floor constructions

Specification of insulation	Thresholds
Non-combustible insulation	Reaction to fire A1 in accordance to EN 13501-1
Insulation thickness	≥ 30 mm
Insulation density	≥ 40 kg/m <sup>3</sup>
Total insulation length	≥ 550 mm
Case of insulation	LS, CS





Name	Dimension scope Ø...Diameter (mm) t <sub>D</sub> ...Pipe wall thickness (mm)	Position of PROMASEAL®-AG	Annular gap Width x depth (mm)	Classification
Copper pipes with ins.	Ø 18 / t <sub>D</sub> 1 - 14,2	Upper and bottom side	20 x 25	<b>EI 120-U/C</b>

The field of application given for copper pipes is also valid for other metal pipes with lower heat conductivity ( $\lambda \leq 380$  W/mK) and a melting point of minimum 1083 °C (e.g. stainless steel, cast iron, Ni alloys (NiCr, NiMo and NiCu alloys) and Ni.

### 3.5 Distances for the PROMASEAL®-AG firestop sealant penetration seal

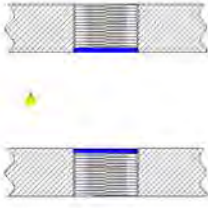
Specimen	Minimum distance (mm)
Cable – Aperture opening	0
Cable bundle – Aperture opening	0
Cable – Cable	0
Conduits – Aperture opening	20
Conduits – Conduits	0
Non-combustible insulation – Aperture opening	10
Non-combustible insulation – Non-combustible insulation	0
Plastic pipes – Aperture opening	20
Between all other installations	100
Supporting distance on both faces of wall constructions	250
Supporting distance on the upper face of floor constructions	250

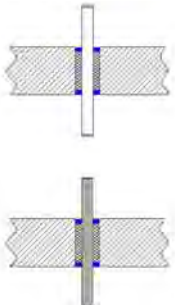
TERVEZÉSI SEGÉDLET

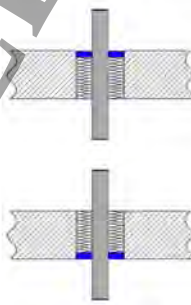
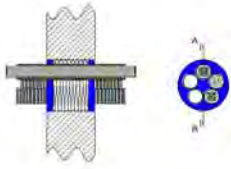
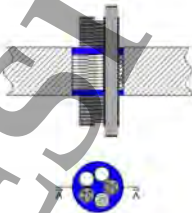
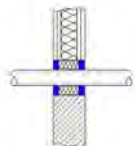
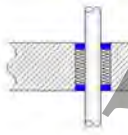
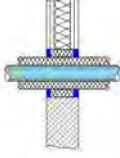
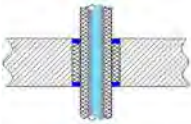
 <p>710.01</p>	 <p>710.02</p>	 <p>710.03</p>
 <p>710.04</p>	 <p>710.05</p>	 <p>710.06</p>
 <p>710.07</p>	 <p>710.08</p>	 <p>710.09</p>
 <p>710.10</p>	 <p>710.11</p>	 <p>710.12</p>
<p><b>Promat</b> PROMAT GmbH St. Peter-Strasse 25 4021 Linz / Austria Phone: +43 732 6912-3621 Fax: +43 732 6912-3740 www.promat.at technik@promat.at © Promat GmbH</p>	<p>Overview of PROMASEAL® -AG solutions Part 1 of 2</p> <p>scale: without drawing format: A4 date: 04.04.2016 division: Technical appl.</p>	<p>modified by/ion: drawn by: KÖRBLER drawing number: 710.001</p>

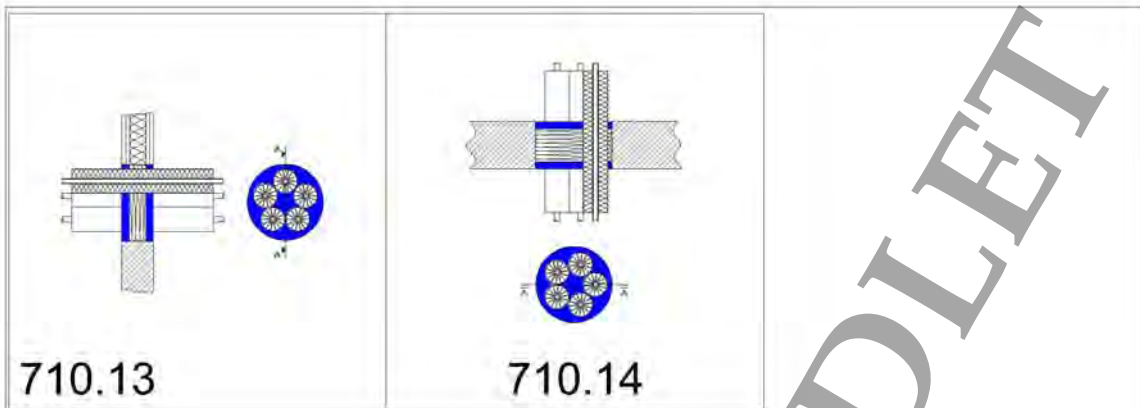

ERVEZÉSI SEGÉDLET

 <b>PROMAT GmbH</b> St.-Peter-Str. 25 4021 Linz / Austria Phone: +43 732 6912-3621 Fax: +43 732 6912-3740 www.promat.at technik@promat.at © Promat GmbH	Overview of PROMASEAL® -AG solutions Part 2 of 2				modified by/on:
	scale: without	drawing format: A4	date: 04.04.2016	division: Technical appl.	drawn by: KÖRBLER
				drawing number: 710.002	

Technical advice and information is given in good faith. Boundary conditions and installation conditions are to be checked on site. All rights, especially germ. Remain copyright and patent laws reserved. Technical documentation (drawings, calculations, design proposals, etc.) and patterns remain the property of Promat®. For failure to reach a goods business, the extent services provided are the seller in the event to pay buyers side using appropriate. Please refer to our delivery and payment.

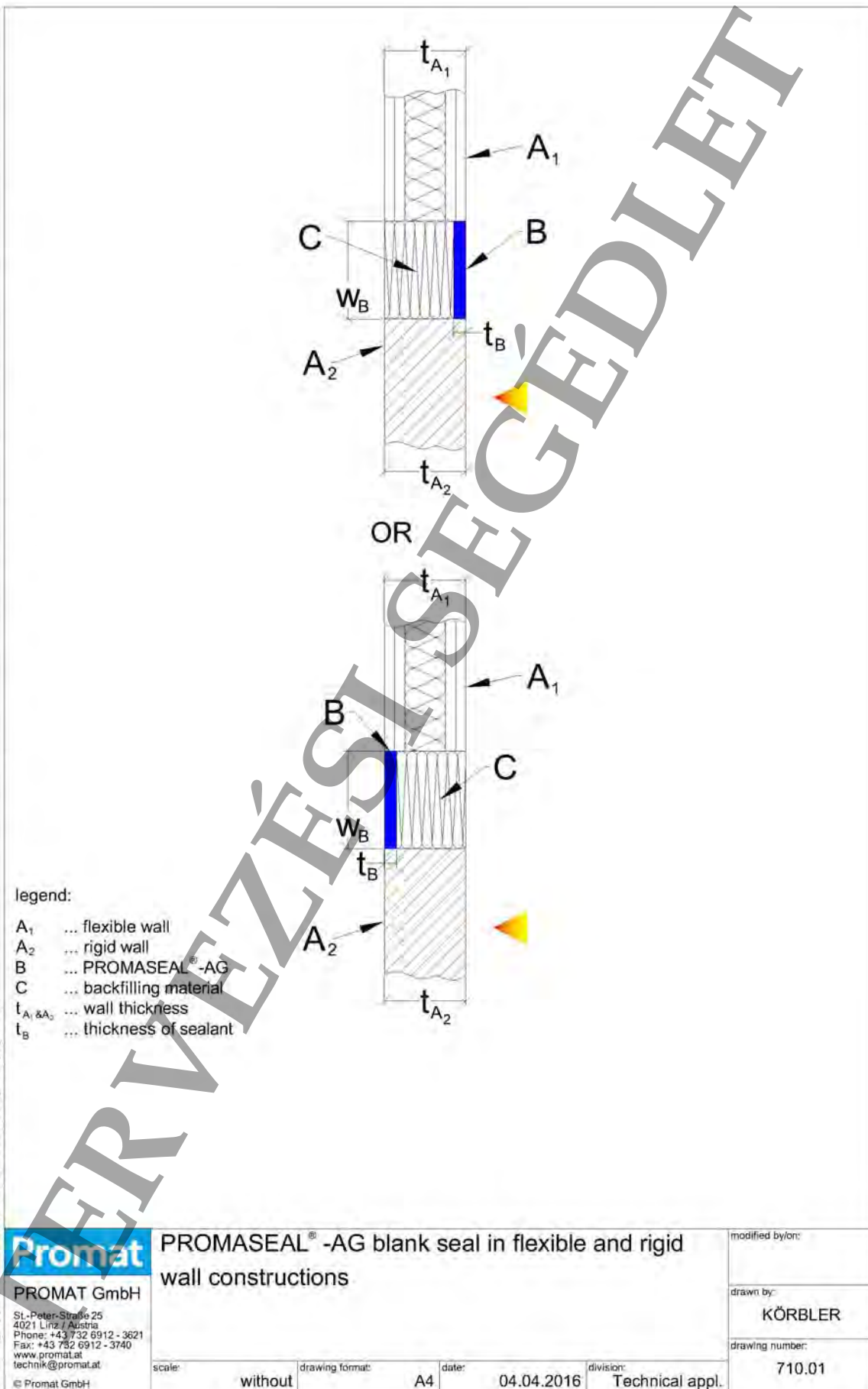

Technical advice and information is given in good faith. Boundary conditions and installation conditions are to be checked on site. All rights, especially germ. Remain copyright and patent laws reserved. Technical documentation (drawings, calculations, design proposals, etc.) and patterns remain the property of Promat®. For failure to reach a goods business, the extent services provided are the seller in the event to pay buyers side using appropriate. Please refer to our delivery and payment.

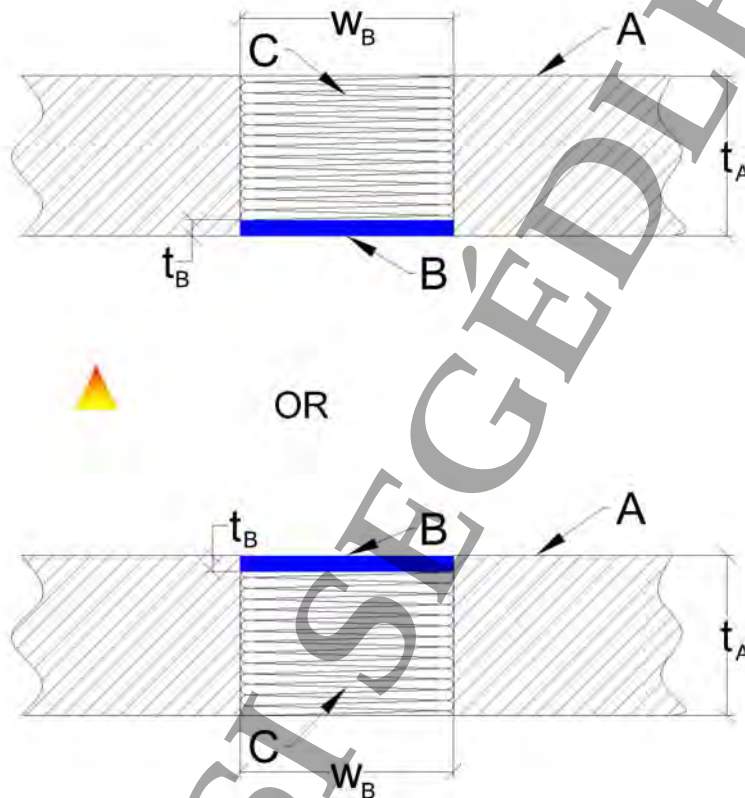

legend:

- A ... rigid floor
- B ... PROMASEAL®-AG
- C ... backfilling material
- $t_A$  ... floor thickness
- $t_B$  ... thickness of sealant

**Promat**

PROMAT GmbH

St.-Peter-Strasse 25  
4021 Linz / Austria  
Phone: +43 732 6912 - 3621  
Fax: +43 732 6912 - 3740  
www.promat.at  
technik@promat.at

© Promat GmbH

PROMASEAL® -AG blank seal in rigid floor  
constructions

modified by/on:

drawn by:

KÖRBLER

drawing number:

710.02

scale:

without

drawing format:

A4

date:

04.04.2016

division:

Technical appl.

Technical advice and information is given in good faith. Boundary conditions and installation conditions are to be checked on site. All rights, especially germ. Remain copyright and patent laws reserved. Technical documentation (drawings, calculations, design proposals, etc.) and patterns remain the property of Promat®. For failure to reach a goods business, the extent services provided are the seller in the event to pay buyers side using appropriate. Please refer to our delivery and payment.

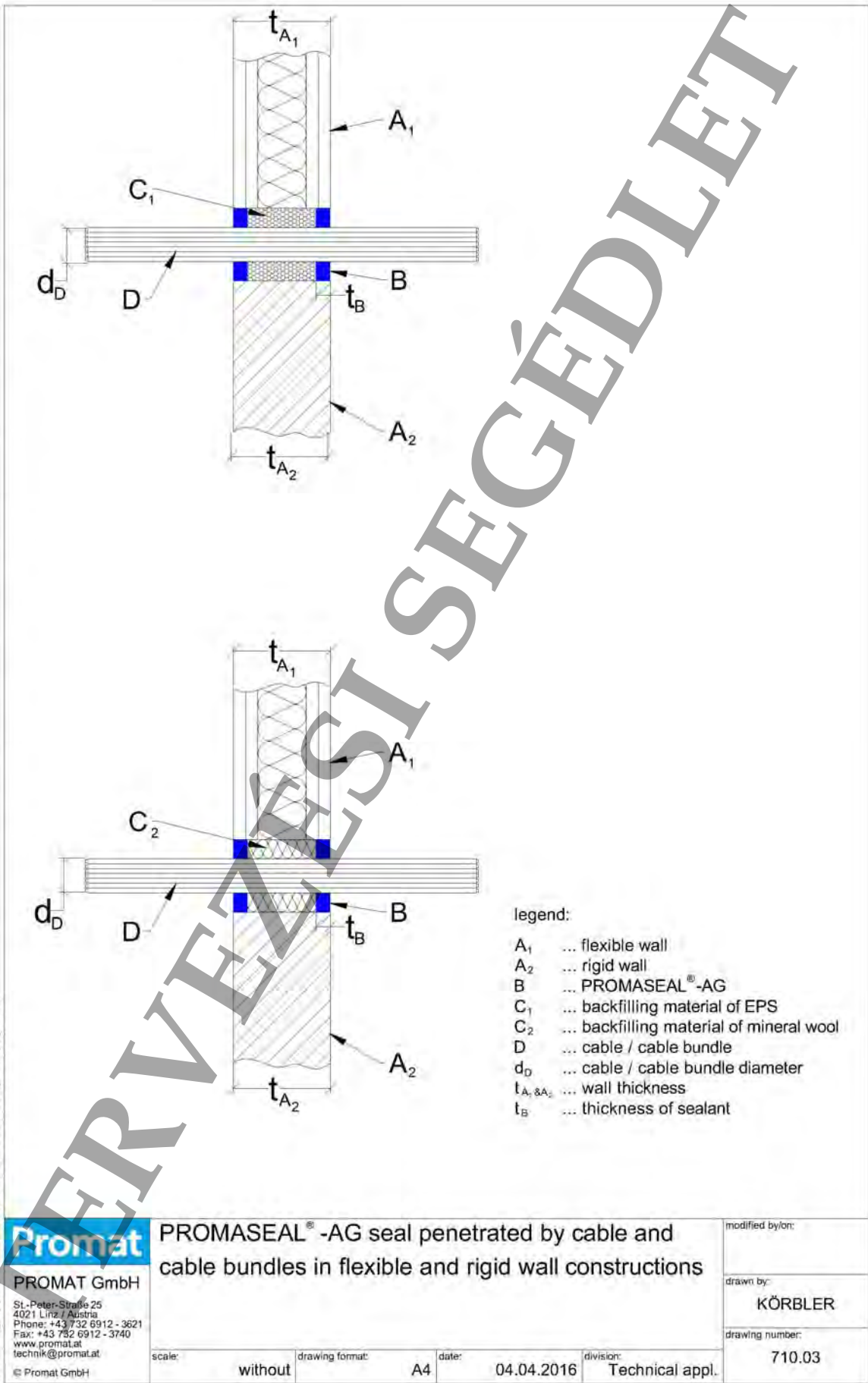

Technical advice and information is given in good faith. Boundary conditions and installation conditions are to be checked on site. All rights, especially germ. Remain copyright and patent laws reserved. Technical documentation (drawings, calculations, design proposals, etc.) and patterns remain the property of Promat®. For failure to reach a goods business, the extent services provided are the seller in the event to pay buyers side using appropriate. Please refer to our delivery and payment.

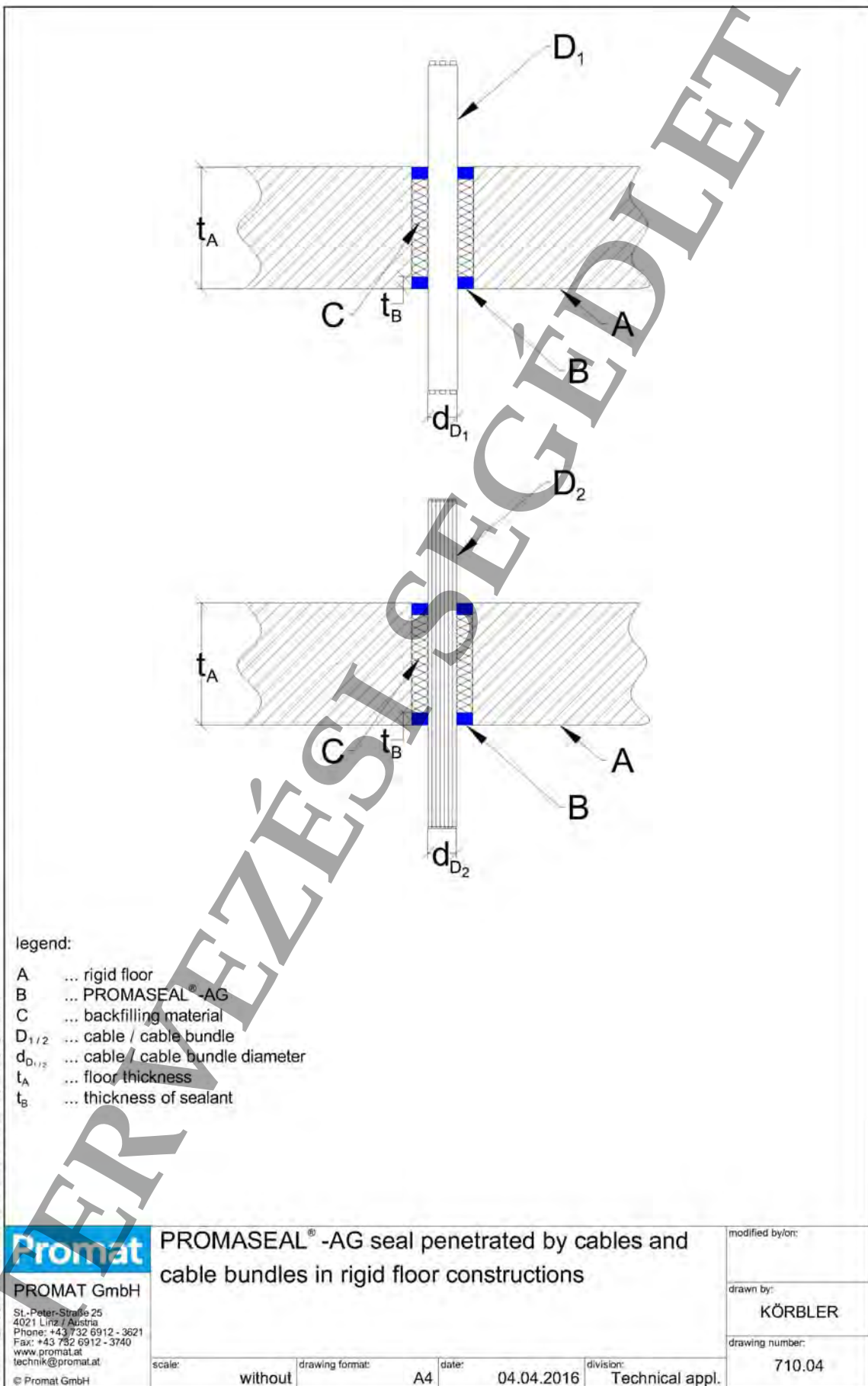



Technical advice and information is given in good faith. Boundary conditions and installation conditions are to be checked on site. All rights, especially germ. Remain copyright and patent laws reserved. Technical documentation (drawings, calculations, design proposals, etc.) and patterns remain the property of Promat®. For failure to reach a goods business, the extent services provided are the seller in the event to pay buyers side using appropriate. Please refer to our delivery and payment.

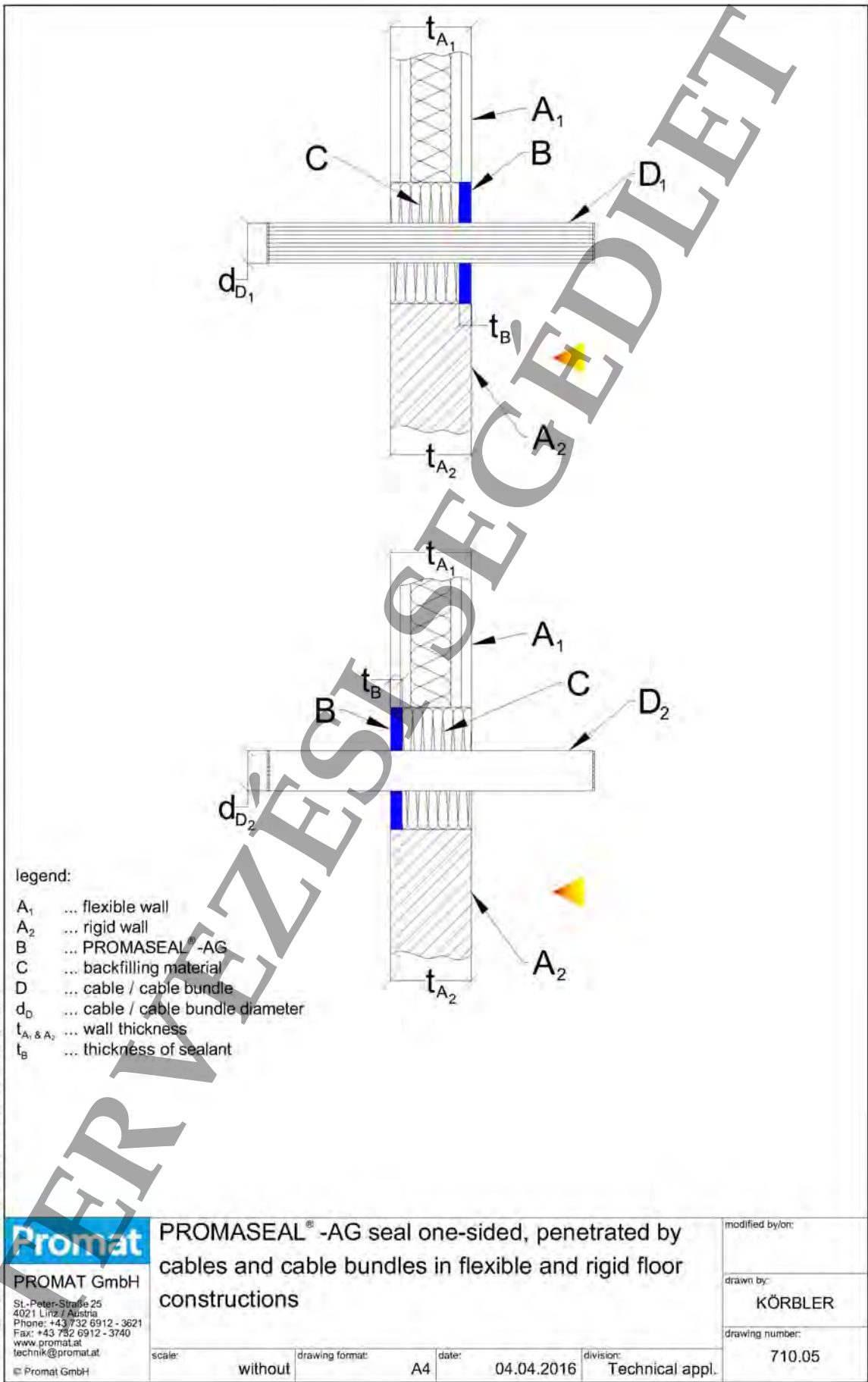

Technical advice and information is given in good faith. Boundary conditions and installation conditions are to be checked on site. All rights, especially germ. Remain copyright and patent laws reserved. Technical documentation (drawings, calculations, design proposals, etc.) and patterns remain the property of Promat®. For failure to reach a goods business, the extent services provided are the seller in the event to pay buyers side using appropriate. Please refer to our delivery and payment.

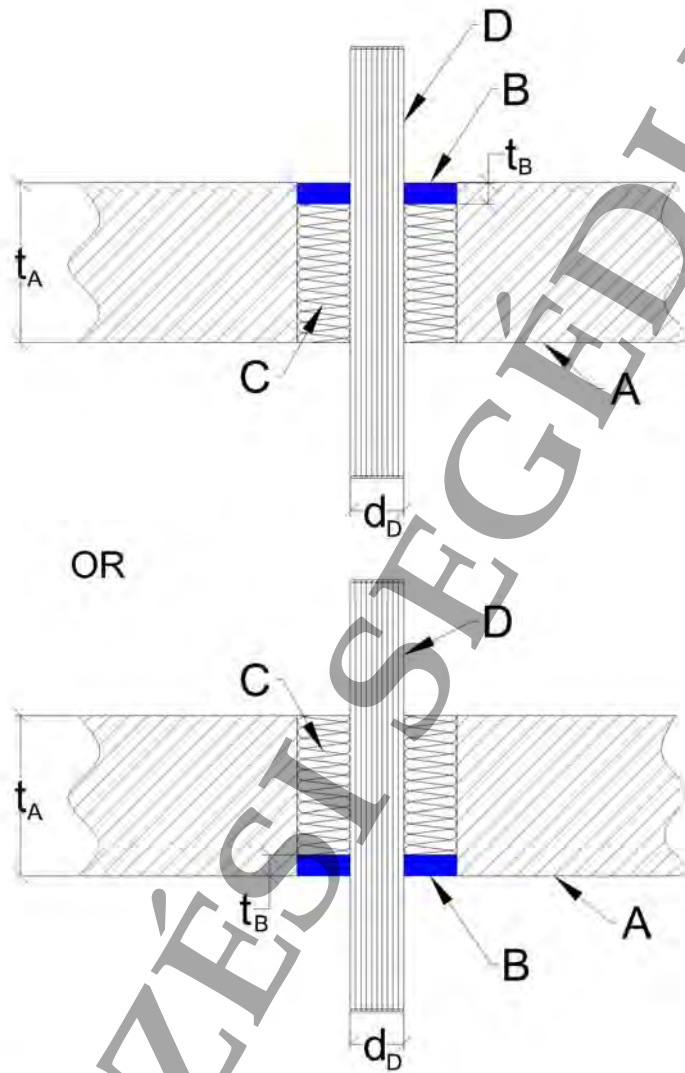

legend:

- A ... rigid floor
- B ... PROMASEAL® -AG
- C ... backfilling material
- D ... cable / cable bundle
- $d_D$  ... cable / cable bundle diameter
- $t_A$  ... floor thickness
- $t_B$  ... thickness of sealant

**Promat**

PROMAT GmbH

St.-Peter-Strasse 25  
4021 Linz / Austria  
Phone: +43 732 6912 - 3621  
Fax: +43 732 6912 - 3740  
www.promat.at  
technik@promat.at

© Promat GmbH

PROMASEAL® -AG seal one-sided, penetrated by  
cables and cable bundles in rigid floor constructions

modified by/on:

drawn by:  
KÖRBLER

drawing number:  
710.06

scale:	without	drawing format:	A4	date:	04.04.2016	division:	Technical appl.
--------	---------	-----------------	----	-------	------------	-----------	-----------------

Technical advice and information is given in good faith. Boundary conditions and installation conditions are to be checked on site. All rights, especially germ. Remain copyright and patent laws reserved. Technical documentation (drawings, calculations, design proposals, etc.) and patterns remain the property of Promat®. For failure to reach a goods business, the extent services provided are the seller in the event to pay buyers side using appropriate. Please refer to our delivery and payment.

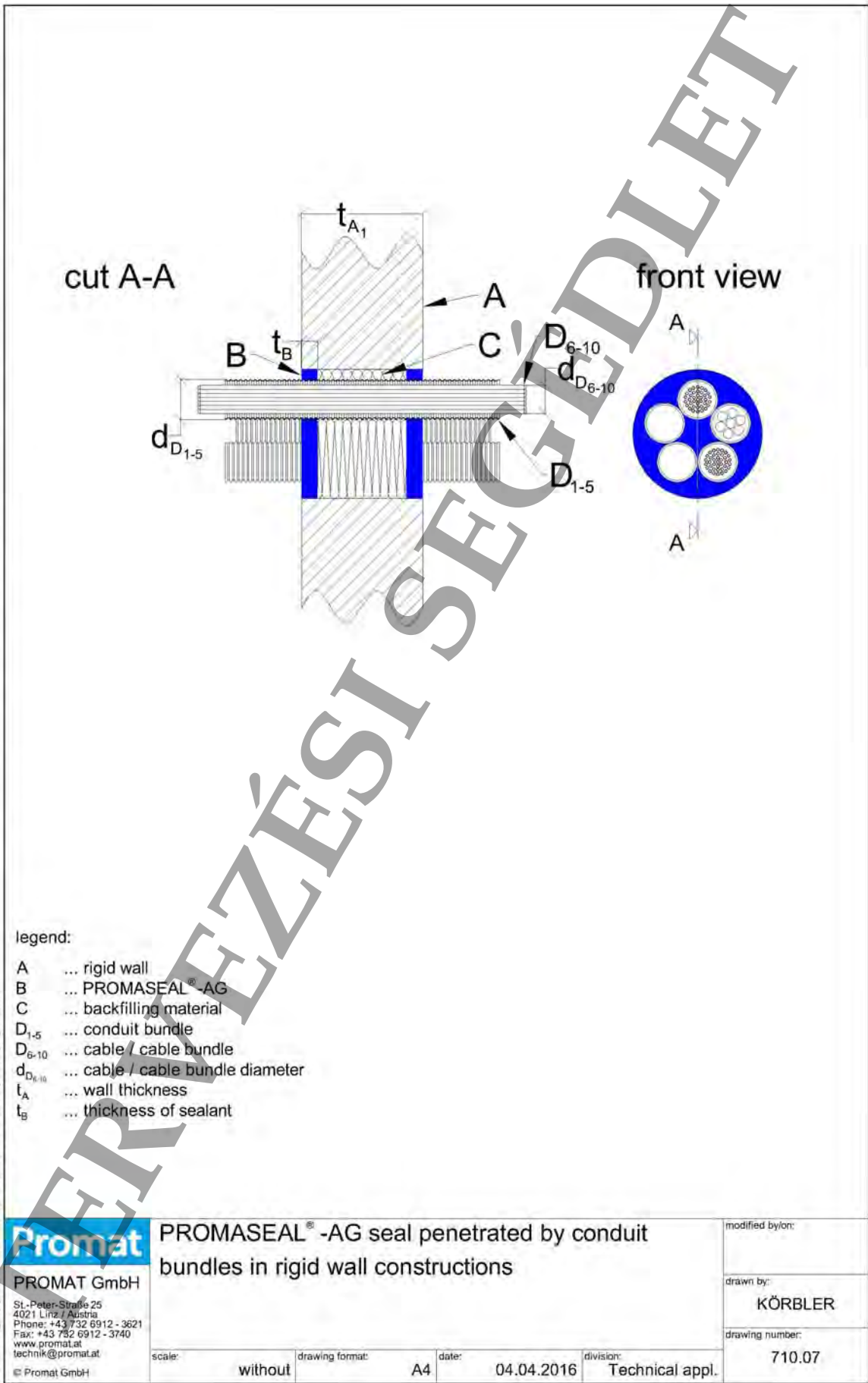

Technical advice and information is given in good faith. Boundary conditions and installation conditions are to be checked on site. All rights, especially germ. Remain copyright and patent laws reserved. Technical documentation (drawings, calculations, design proposals, etc.) and patterns remain the property of Promat®. For failure to reach a goods business, the extent services provided are the seller in the event to pay buyers side using appropriate. Please refer to our delivery and payment.

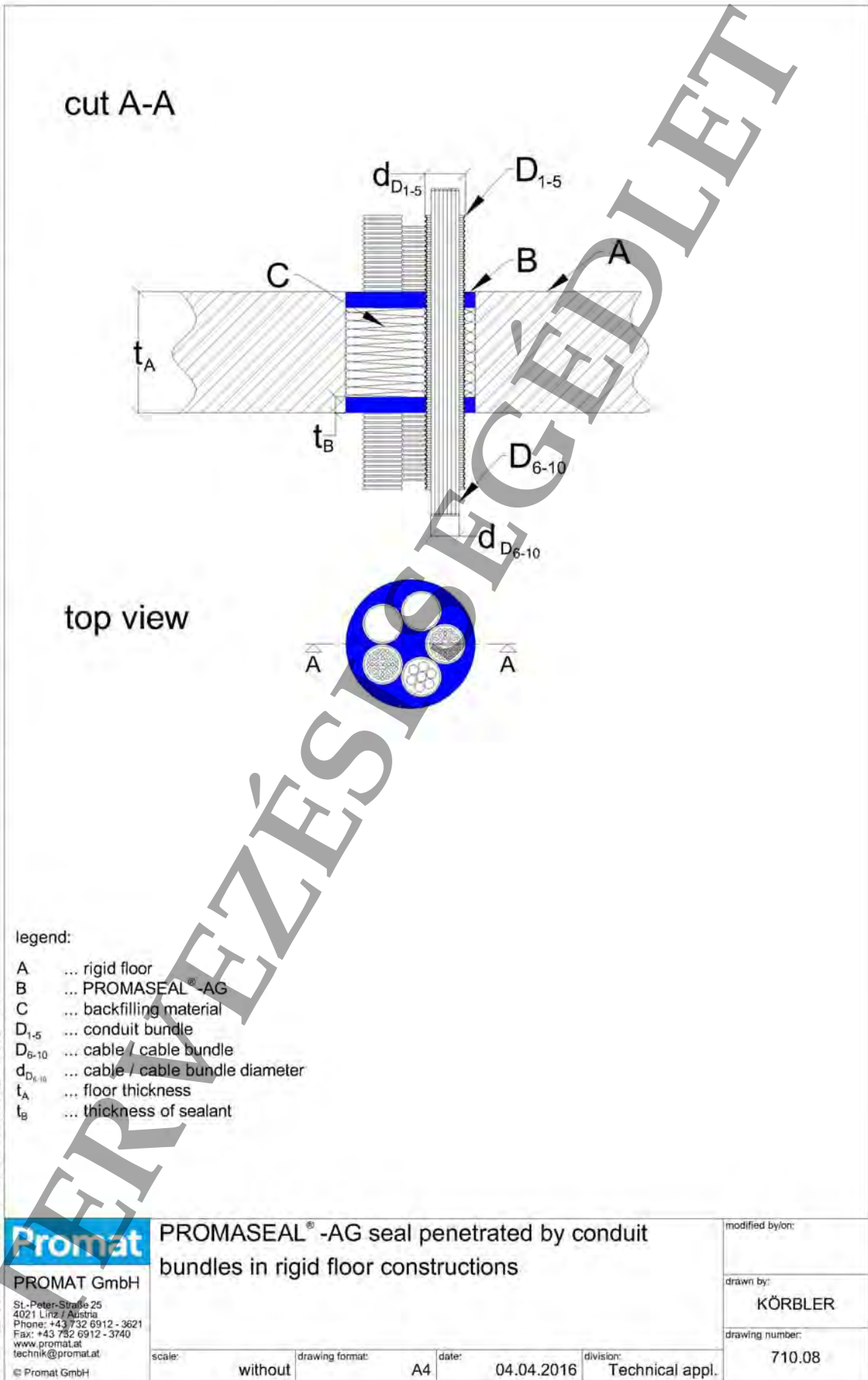

Technical advice and information is given in good faith. Boundary conditions and installation conditions are to be checked on site. All rights, especially germ. Remain copyright and patent laws reserved. Technical documentation (drawings, calculations, design proposals, etc.) and patterns remain the property of Promat®. For failure to reach a goods business, the extent services provided are the seller in the event to pay buyers side using appropriate. Please refer to our delivery and payment.

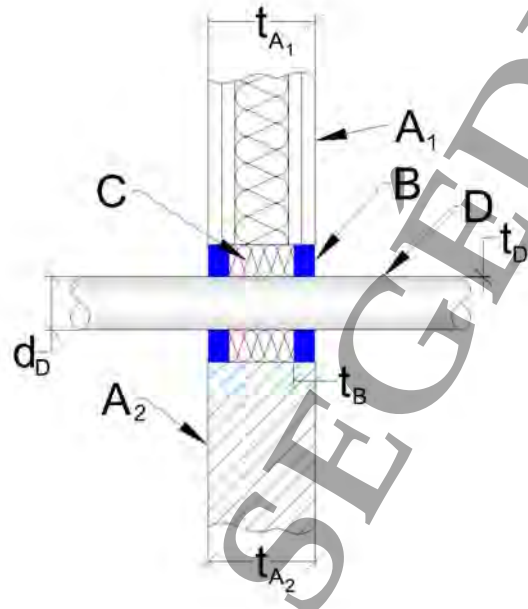

legend:

- A<sub>1</sub> ... flexible wall
- A<sub>2</sub> ... rigid wall
- B ... PROMASEAL®-AG
- C ... backfilling material
- D ... plastic pipe
- d<sub>D</sub> ... plastic pipe diameter
- t<sub>A<sub>1</sub> & A<sub>2</sub></sub> ... wall thickness
- t<sub>B</sub> ... thickness of sealant
- t<sub>D</sub> ... pipe wall thickness



PROMAT GmbH

St.-Peter-Strasse 25  
4021 Linz / Austria  
Phone: +43 732 6912 - 3621  
Fax: +43 732 6912 - 3740  
www.promat.at  
technik@promat.at

© Promat GmbH

PROMASEAL® -AG seal penetrated by plastic pipes  
in flexible and rigid wall constructions

modified by/on:

drawn by:  
KÖRBLER

drawing number:  
710.09

scale:	without	drawing format:	A4	date:	04.04.2016	division:	Technical appl.
--------	---------	-----------------	----	-------	------------	-----------	-----------------

Technical advice and information is given in good faith. Boundary conditions and installation conditions are to be checked on site. All rights, especially germ. Remain copyright and patent laws reserved. Technical documentation (drawings, calculations, design proposals, etc.) and patterns remain the property of Promat®. For failure to reach a goods business, the extent services provided are the seller in the event to pay buyers side using appropriate. Please refer to our delivery and payment.

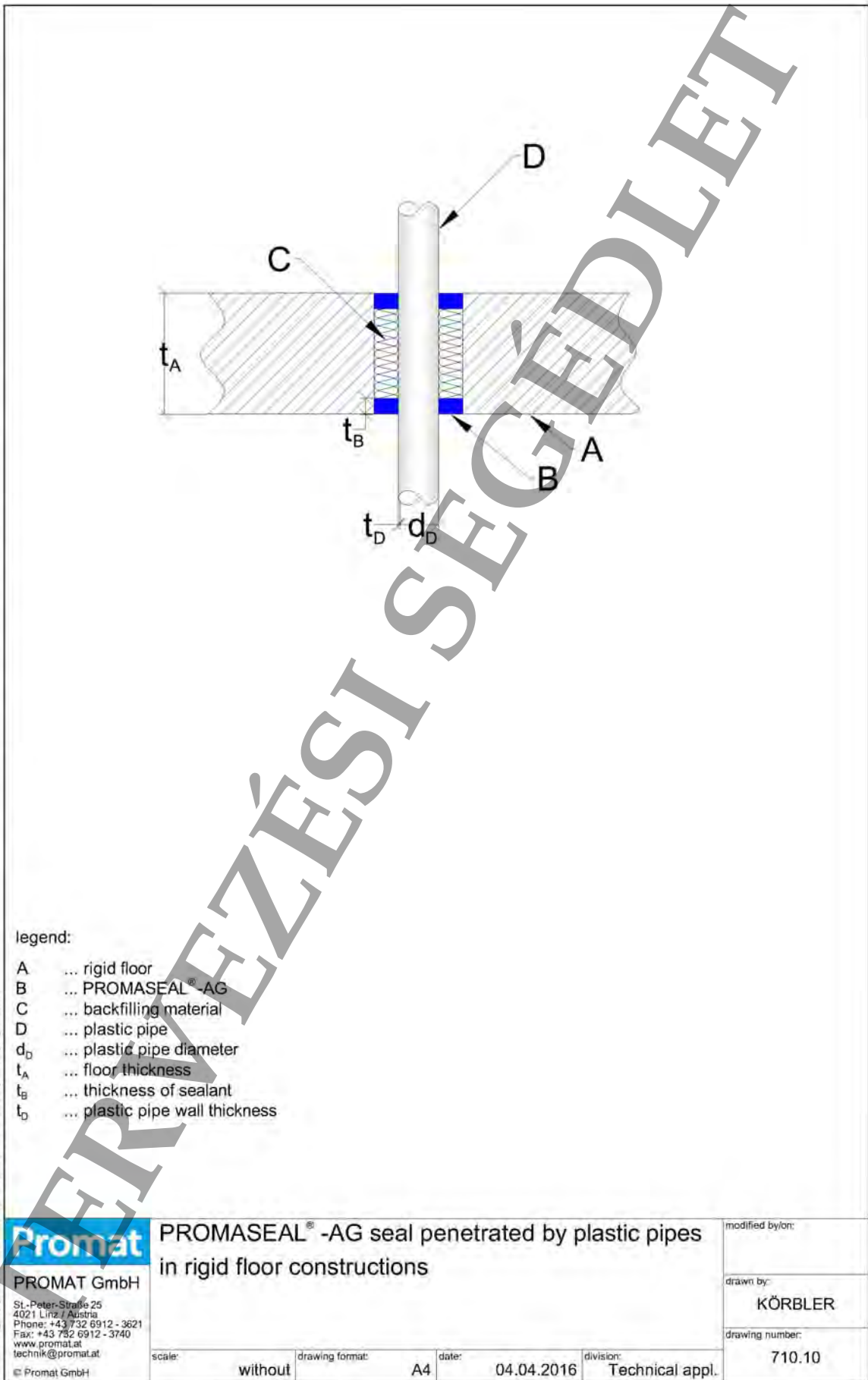

legend:

- A ... rigid floor
- B ... PROMASEAL® -AG
- C ... backfilling material
- D ... plastic pipe
- $d_D$  ... plastic pipe diameter
- $t_A$  ... floor thickness
- $t_B$  ... thickness of sealant
- $t_D$  ... plastic pipe wall thickness

**Promat**

**PROMAT GmbH**

St.-Peter-Strasse 25  
4021 Linz / Austria  
Phone: +43 732 6912 - 3621  
Fax: +43 732 6912 - 3740  
www.promat.at  
technik@promat.at

© Promat GmbH

**PROMASEAL® -AG seal penetrated by plastic pipes  
in rigid floor constructions**

modified by/on:

drawn by:

**KÖBLER**

drawing number:

**710.10**

scale:

**without**

drawing format:

**A4**

date:

**04.04.2016**

division:

**Technical appl.**

Technical advice and information is given in good faith. Boundary conditions and installation conditions are to be checked on site. All rights, especially gem. Remain copyright and patent laws reserved. Technical documentation (drawings, calculations, design proposals, etc.) and patterns remain the property of Promat®. For failure to reach a goods business, the extent services provided are the seller in the event to pay buyers side using appropriate. Please refer to our delivery and payment.

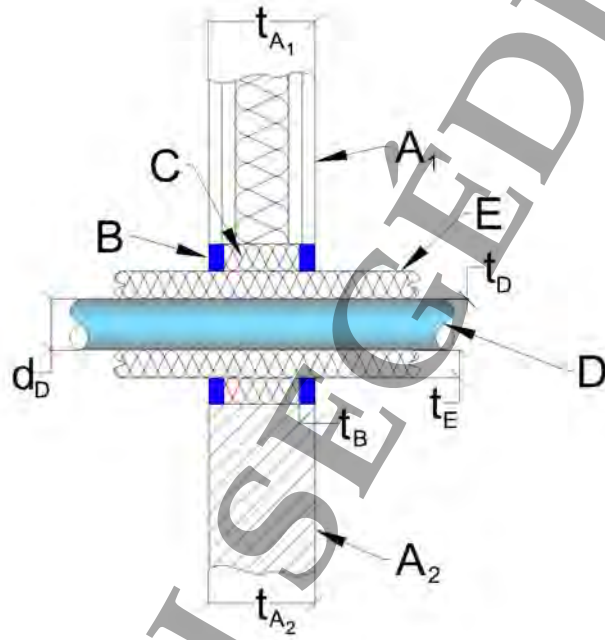

legend:

- A<sub>1</sub> ... flexible wall
- A<sub>2</sub> ... rigid wall
- B ... PROMASEAL® -AG
- C ... backfilling material
- D ... metal pipe
- E ... mineral wool insulation
- d<sub>D</sub> ... metal pipe diameter
- t<sub>A<sub>1</sub> & A<sub>2</sub></sub> ... wall thickness
- t<sub>B</sub> ... thickness of sealant
- t<sub>D</sub> ... pipe wall thickness
- t<sub>E</sub> ... thickness of insulation



PROMAT GmbH

St.-Peter-Strasse 25  
4021 Linz / Austria  
Phone: +43 732 6912 - 3621  
Fax: +43 732 6912 - 3740  
www.promat.at  
technik@promat.at

© Promat GmbH

PROMASEAL® -AG seal penetrated by metal pipes  
in flexible and rigid wall constructions

modified by/on:

drawn by:  
KÖRBLER

drawing number:  
710.11

scale:	without	drawing format:	A4	date:	04.04.2016	division:	Technical appl.
--------	---------	-----------------	----	-------	------------	-----------	-----------------

Technical advice and information is given in good faith. Boundary conditions and installation conditions are to be checked on site. All rights, especially germ. Remain copyright and patent laws reserved. Technical documentation (drawings, calculations, design proposals, etc.) and patterns remain the property of Promat®. For failure to reach a goods business, the extent services provided are the seller in the event to pay buyers side using appropriate. Please refer to our delivery and payment.

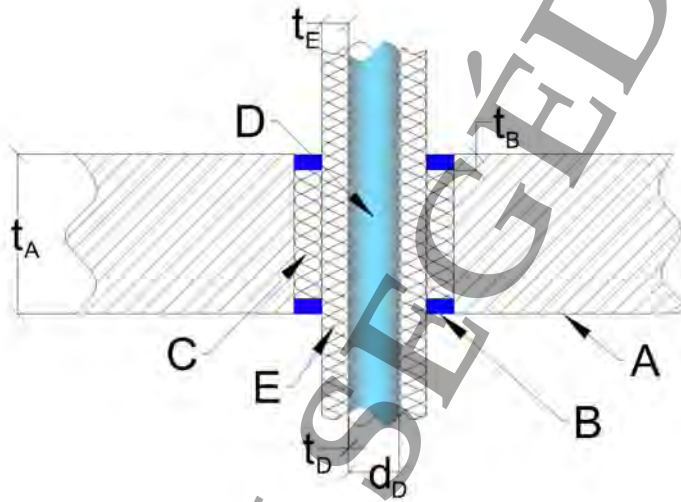

legend:

- A ... rigid floor
- B ... PROMASEAL® -AG
- C ... backfilling material
- D ... metal pipe
- E ... mineral wool insulation
- $d_B$  ... metal pipes diameter
- $t_A$  ... floor thickness
- $t_B$  ... thickness of sealant
- $t_D$  ... metal pipe wall thickness
- $t_E$  ... insulation thickness



PROMAT GmbH

St.-Peter-Strasse 25  
4021 Linz / Austria  
Phone: +43 732 6912 - 3621  
Fax: +43 732 6912 - 3740  
www.promat.at  
technik@promat.at

© Promat GmbH

PROMASEAL® -AG seal penetrated by metal pipes  
in rigid floor constructions

modified by/on:

drawn by:  
KÖRBLER

drawing number:  
710.12

scale:	without	drawing format:	A4	date:	04.04.2016	division:	Technical appl.
--------	---------	-----------------	----	-------	------------	-----------	-----------------



Technical advice and information is given in good faith. Boundary conditions and installation conditions are to be checked on site. All rights, especially germ. Remain copyright and patent laws reserved. Technical documentation (drawings, calculations, design proposals, etc.) and patterns remain the property of Promat®. For failure to reach a goods business, the extent services provided are the seller in the event to pay buyers side using appropriate. Please refer to our delivery and payment.

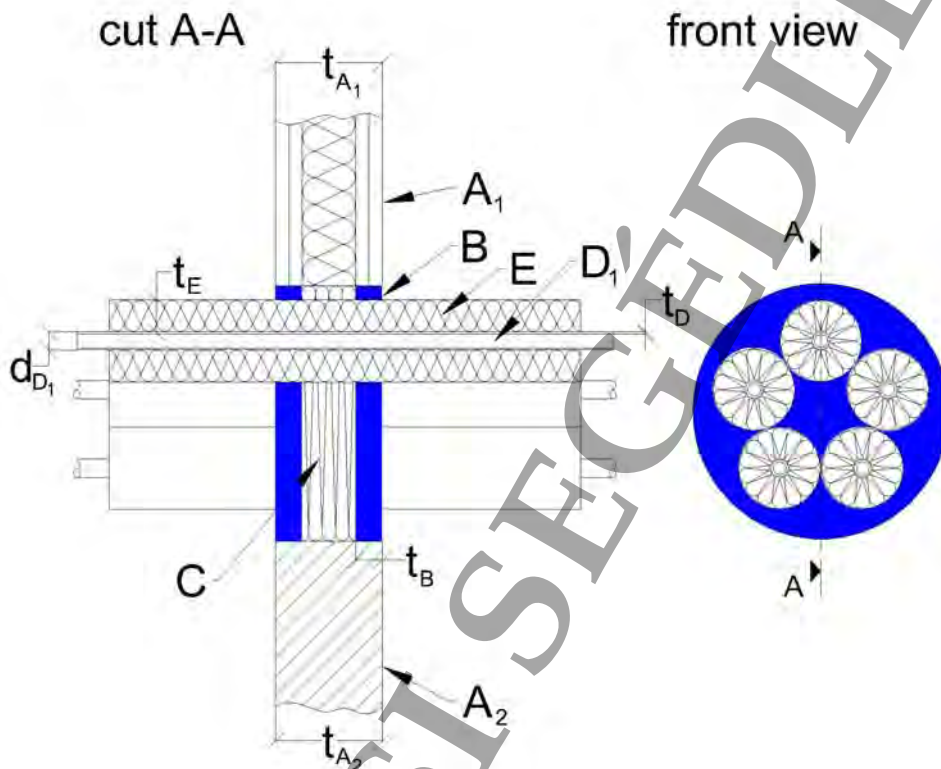

legend:

- A<sub>1</sub> ... flexible wall
- A<sub>2</sub> ... rigid wall
- B ... PROMASEAL® -AG
- C ... backfilling material
- D<sub>1-5</sub> ... metal pipes
- E<sub>1-5</sub> ... mineral wool insulation
- d<sub>D1-5</sub> ... metal pipe diameter
- t<sub>A1 & A2</sub> ... wall thickness
- t<sub>B</sub> ... thickness of sealant
- t<sub>D1-5</sub> ... pipe wall thickness
- t<sub>E</sub> ... thickness of insulation

**Promat**

PROMAT GmbH

St.-Peter-Strasse 25  
4021 Linz / Austria  
Phone: +43 732 6912 - 3621  
Fax: +43 732 6912 - 3740  
www.promat.at  
technik@promat.at

© Promat GmbH

PROMASEAL® -AG seal penetrated by metal pipe  
bundles in flexible and rigid wall constructions

modified by/on:

drawn by:

KÖRBLER

drawing number:

710.13

scale:

without

drawing format:

A4

date:

04.04.2016

division:

Technical appl.

Technical advice and information is given in good faith. Boundary conditions and installation conditions are to be checked on site. All rights, especially gen. Remain copyright and patent laws reserved. Technical documentation (drawings, calculations, design proposals, etc.) and patterns remain the property of Promat®. For failure to reach a goods business, the extent services provided are the seller in the event to pay buyers side using appropriate. Please refer to our delivery and payment.

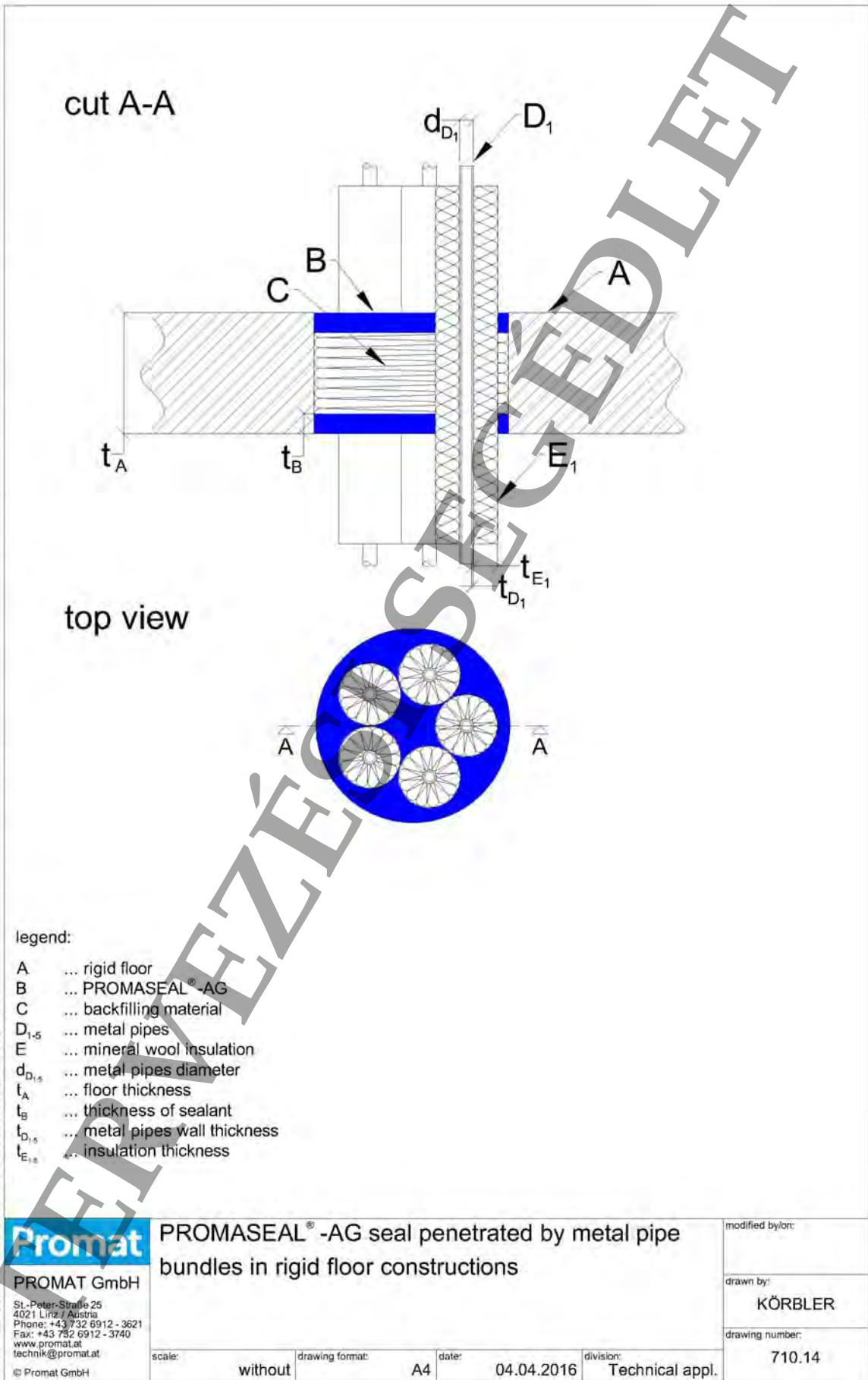

blank page

**TERVEZÉSI SEGÉDLET**

blank page

**TERVEZÉSI SEGÉDLET**