

[Go to Content](#)

Content	Detail No.	Page
General information		<u>3</u>
Components		<u>4</u>
Support frame		<u>7</u>
Ventilation		<u>8</u>
Vertical joint	<u>1</u>	<u>10</u>
Intermediate support	<u>2</u>	<u>10</u>
Vertical control joint	<u>3</u>	<u>11</u>
Vertical joint at angle	<u>4</u>	<u>11</u>
Open horizontal joint junction with vertical joint	<u>5</u>	<u>12</u>
Open horizontal movement joint	<u>6</u>	<u>13</u>
Baffled horizontal movement joint	<u>7</u>	<u>13</u>
Base detail – Ground floor	<u>8</u>	<u>14</u>
Base detail – Covered area (not exposed to direct precipitation)	<u>9</u>	<u>14</u>
Base detail – Balcony	<u>10</u>	<u>15</u>
Base detail – Flat roof abutment / Parapet	<u>11</u>	<u>15</u>
Window head – Option 1	<u>12</u>	<u>16</u>
Window sill – Option 1	<u>13</u>	<u>16</u>
Window head – Option 2	<u>14</u>	<u>17</u>
Window sill – Option 2	<u>15</u>	<u>17</u>
Window head – Flush window	<u>16</u>	<u>18</u>
Window sill – Flush window	<u>17</u>	<u>18</u>
Window head – With sunscreen	<u>18</u>	<u>19</u>
Window head – With shutter	<u>19</u>	<u>20</u>
Window jamb – Option 1	<u>20</u>	<u>21</u>
Window jamb – Metal flashing	<u>21</u>	<u>21</u>
Window jamb – Option 2	<u>22</u>	<u>22</u>
Capping	<u>23</u>	<u>23</u>
External corner	<u>24</u>	<u>24</u>
External corner with wind barrier	<u>25</u>	<u>25</u>
Internal corner	<u>26</u>	<u>26</u>
Abutment	<u>27</u>	<u>26</u>
Junction with other facade material – Head detail	<u>28</u>	<u>27</u>
Junction with other facade material – Base	<u>29</u>	<u>27</u>
Segmented façade – Radius < 12 m	<u>30</u>	<u>28</u>
Curved façade – Radius ≥ 12 m	<u>31</u>	<u>28</u>
Soffit/ceiling–wall junction	<u>32</u>	<u>29</u>
Wall–soffit/ceiling junction	<u>33</u>	<u>30</u>
Junction with panels with concealed fixings	<u>34</u>	<u>31</u>

## General information

This document provides generic construction details for EQUITONE façade systems with UNI Screw panel face fixings on timber batten support frame to assist with the design of EQUITONE façade.

This document is not designed to serve as an installation guide and is intended to be used in conjunction with the relevant EQUITONE Planning and Application Guide and other technical and installation documents.

The details included in this document only illustrate general principles for detailing of EQUITONE at different typical interfaces; and are not to be relied upon for weatherproofing and fire safety compliance with local regulations. The weatherproofing and fire performance of any project specific detail or application shall be evaluated by the project engineer or consultant.

Any components related to wind barriers, fire safety, moisture management and weather proofing including but not limited to membranes, flashings, water seals and sealants, airtightness tapes, horizontal and/or vertical fire barriers, etc, will need to be applied according to local regulations, project requirements and relevant standards.

The support frame, fixings, flashings, and the like shall be of adequate corrosion resistance appropriate to the corrosivity category of the project location.

All dimensions in this document are in millimetre (mm).

The information in this guide is comprehensive but not exhaustive, and the reader will need to satisfy themselves that the contents of this guide are suitable for their intended application. It is the responsibility of the project consultants (designer, architect, and engineers) to ensure that the information and details provided in this document are appropriate for the project.

The information in this document is correct at the time of issuing. However, due to our committed program of continuous material and system development we reserve the right to amend or alter the information contained in this document without prior notice. Please visit [www.equitone.com](http://www.equitone.com) to ensure you have the most current version.

This document is supplied in good faith and no liability can be accepted for any loss or damage resulting from its use. Images and construction details contained in this document are not to a specific scale, are indicative and for illustration purposes only and should not be used as final construction drawings.

This document is protected by international copyright laws. Reproduction and distribution in whole or in part without prior written permission is strictly prohibited. EQUITONE and logos are trademarks of Etex NV or an affiliate thereof. Any use without authorisation is strictly prohibited and may violate trademark laws.



Please visit [www.equitone.com](http://www.equitone.com) for contact details and further information and technical documents.

# Components

## Materials



EQUITONE [linea]

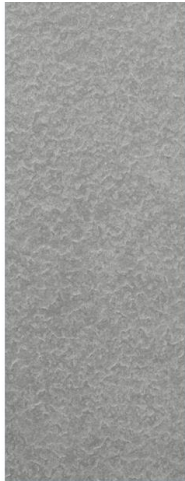

EQUITONE [lunara]



EQUITONE [tectiva]



EQUITONE [natura],  
[natura] PRO



EQUITONE [pictura]



EQUITONE [textura]

## Maximum usable panel sizes

EQUITONE [linea]  
EQUITONE [lunara]  
EQUITONE [tectiva]

10 mm  
10 mm  
8 and 10 mm

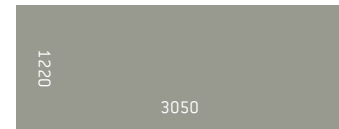
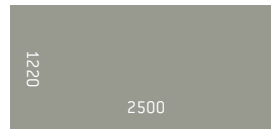

EQUITONE [natura]  
EQUITONE [natura] PRO  
EQUITONE [pictura]  
EQUITONE [textura]

8 and 12 mm  
8 and 12 mm  
8 and 12 mm  
8 and 12 mm

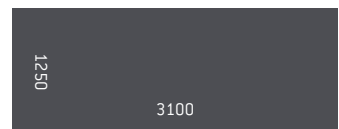
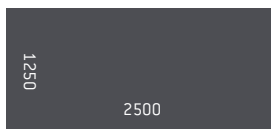

[Go to Content](#)

**Panel fixings: UNI-Screw**

Colour matched and available in the following materials and grades:

Stainless Steel A2 - Material number 1.4567

Available with additional protective coating (C5 acc. ISO 12944-2 ) for use in e. g. coastal areas

Stainless Steel A4 - Material number 1.4401

Available with additional protective coating (C5 acc. ISO 12944-2 ) for use in e. g. coastal areas

UNI-Screws have a drillpoint.

The screw has a Torx TTAP20 socket cap.



**Screw collar**

Stainless Steel 304 ( A2 ) -Material number 1.4567

Must be used together with UNI-Screw when fixing EQUITONE [natura] PRO and EQUITONE [pictura].



Each panel thickness has its own corresponding UNI-Screw.

Panel type	Screw type
8 mm EQUITONE [natura]	5,5x40 DP K15 UNI-Screw
8 mm EQUITONE [natura] PRO	
8 mm EQUITONE [pictura]	
8 mm EQUITONE [textura]	
EQUITONE [tectiva]	
EQUITONE [linea]	
EQUITONE [lunara]	
12 mm EQUITONE [natura]	5,5x50 DP K15 UNI-Screw
12 mm EQUITONE [natura] PRO	
12 mm EQUITONE [pictura]	
12 mm EQUITONE [textura]	

[Go to Content](#)

Panel hole size is 7 mm, drilled with 7 mm EQUITONE drill bit.

UNI-Screw recommended panel edge distance:

From the edge parallel to support frame: 25 – 100 mm (Bare minimum 20 mm)

From the edge perpendicular to support frame: 70 – 100 mm

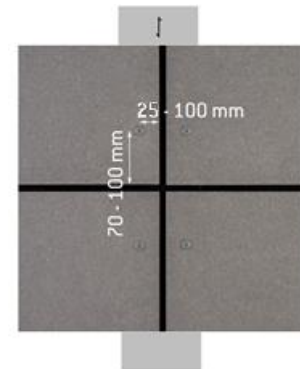

### EPDM tape

Black UV resistant EPDM used over timber battens Used to protect the timber against moisture ingress.

Available as flat tape or as tape with ridges in different widths to suit a range of support frame batten widths.

Flat tape: 70 mm, 110 mm and 130 mm

Ribbed tape: 45 mm and 90 mm

Thickness:  $\geq 1$  mm

0.75 mm thick EPDM- flat tape can only be used to cover the battens behind corner profiles.



### Perforated Closure

Aluminium perforated profile used to close the cavity entry and outlet to prevent the entry of birds and vermin.

Available in four different widths to suit a range of cavity thicknesses and two different colours: uncoated aluminium and black coated aluminium.

The perforation rate is approximately 35 %.



### Baffle

Black coated aluminium baffle used to close and form expressed panel horizontal joint.

The profile has a thickness of 0.6 mm



## Support frame

Batten dimensions are valid only for Uni-screws with Drill-Point. For Uni-screws with Sharp-Point, batten widths need to be increased according to local regulations and relevant standards.

### Timber battens

Minimum thickness: 32 mm

Minimum width for intermediate batten: 50 mm

Minimum width for vertical joint support: 110 mm or 2 times 55 mm

Edge distance from batten end: minimum 40 mm

Note: The above values are recommended minimums and could be greater according to local regulations and standards, local standard sizes of battens and static calculation.

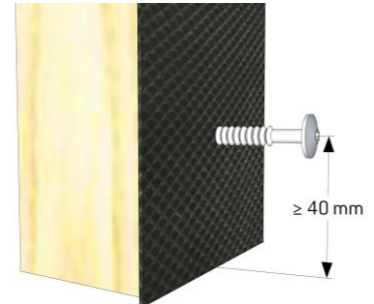

### Timber batten fixings

The details in this document don't include batten fixings.

There are various number of fixings methods, very often based on local habits and construction methods:

- Adjustable brackets placed alternately to the left and the right of the vertical batten
- Construction with counter battens
- U-shaped batten holders
- Window frame dowel (distance screws)
- Batten holders with spacer

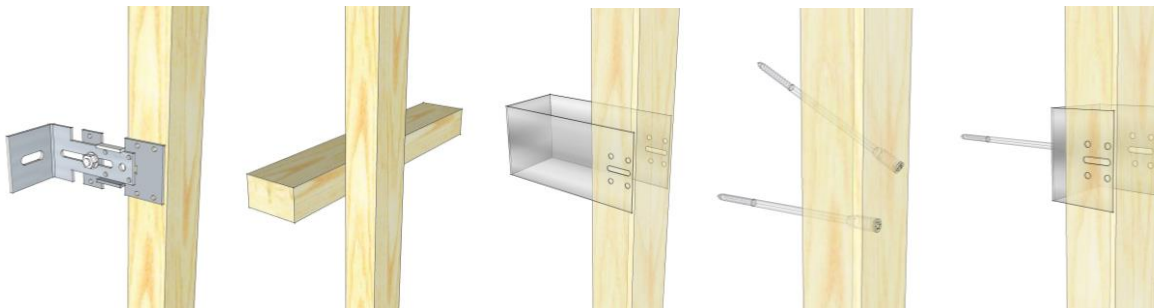

### Notes

The cladding support frame and its connection to the substructure shall be designed and selected by the project engineer in accordance with the relevant standards. The support frame maximum deflection under the influence of load shall be limited to  $\text{Span}/300$  with a maximum of 4 mm, excluding the influence of creep.

Timber framing must comply with local standards.

The minimum recommended grade of structural batten is Class C24 according to EN 14081-1. Local specific requirements must be adhered to as well.

Timber batten must be sufficiently durable for the application in accordance with applicable local regulations.

Timber shall be seasoned or have reached an equilibrium moisture content of 20% or less at the time of installation.

Unseasoned timber is not recommended.

## Ventilation

A ventilated facade is a kind of two stage construction, an inner structure with a protective outer skin, and the cladding panel or rainscreen. A ventilated facade consists of an insulated and weathertight structure, a ventilated cavity formed with a cladding support frame and the cladding panel.

The bare minimum clear gap (cavity width) for ventilation behind the panels is 20 mm and may need to be increased based on the vertical distance between ventilation inlet and outlet. Typical cavity width will be governed by the framing dimensions and be approximately 30 to 60 mm.

Air must be allowed to enter the cavity from bottom of the façade, window head, soffit, slab junctions, and the like, and exit from top of the façade, capping, window sill, slab and soffit interfaces, and the like.

The size of inlets and outlets should be executed as stipulated in this document and the Planning & Application Guide or according to local standards and building regulations. The following requirements are bare minimums.

### Ventilation without perforated closure

The size of ventilation inlet and outlet should be between 10 and 20 mm ( $\geq 100$  cm<sup>2</sup>/m) and may need to be increased depending on local regulations and/or the vertical distance between them (cladding height).

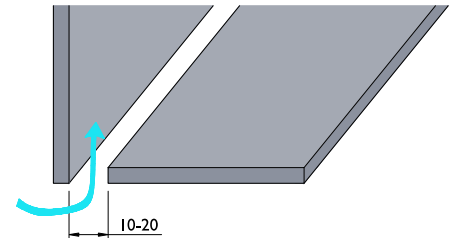

### Ventilation with perforated closure

If by local regulations the use of a perforated closure is required e. g. to vermin proof the cavity then the size of the inlet and outlet must be increased depending on the open area percentage of the used profile to achieve a bare minimum open area of more than 100 cm<sup>2</sup>/m. E.g., in case of a 35 % perforated closure the minimum open gap should be minimum 30 mm

The minimum open area may need to be increased depending on local regulations and/or the vertical distance between the ventilation inlet and outlet (cladding height)

The perforated angle should be less than 0.8 mm in thickness when placed between EQUITONE and the support frame

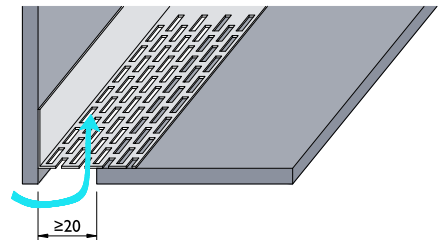



Important points to consider (Do's and Don'ts)

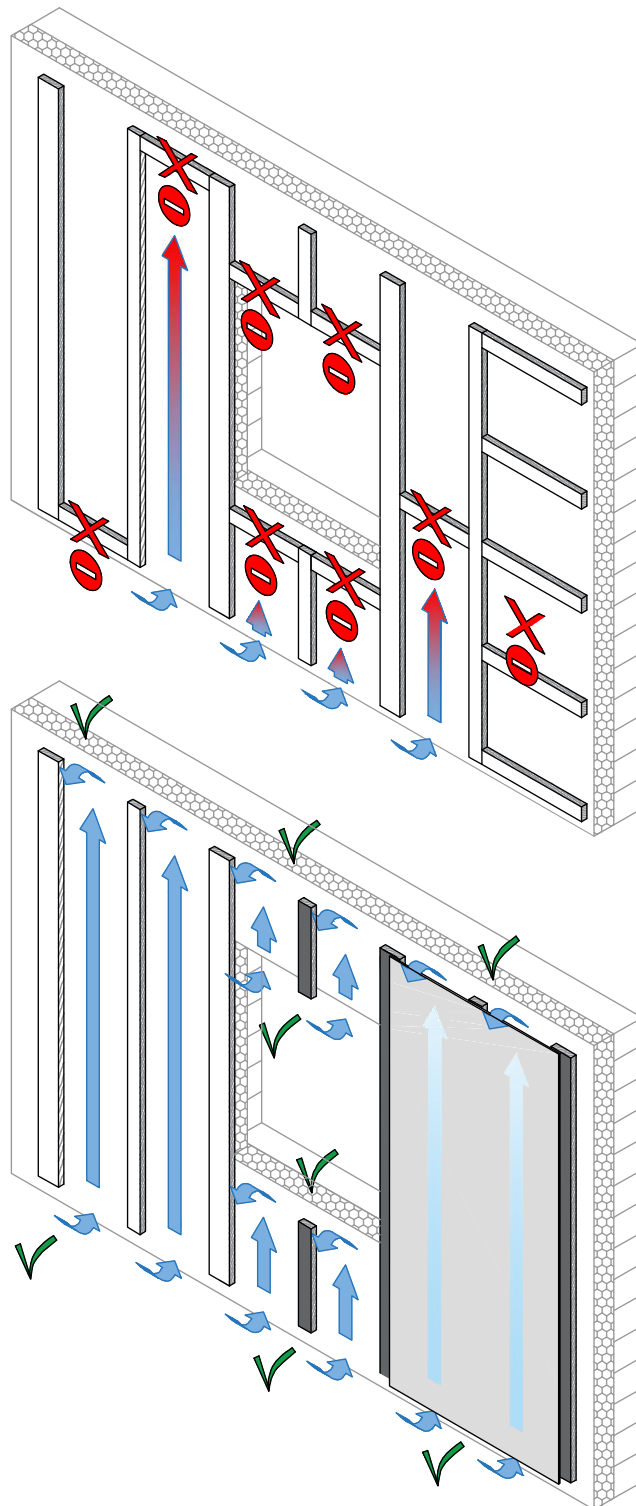

1. EQUITONE facade panel
2. EPDM
3. Timber support frame
4. UNI-Screw
5. Alternative ribbed EPDM<sup>(2)</sup>
6. Screw collar

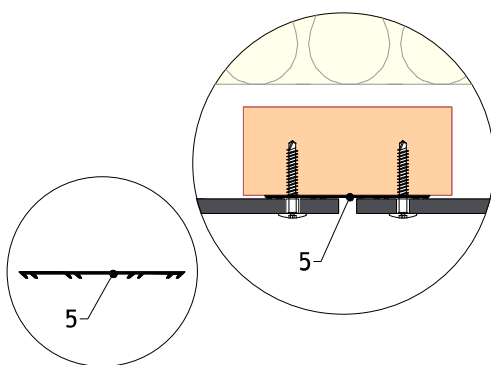

EQUITONE UNI-Screw DP  
with collar  
for EQUITONE [natura] PRO  
and EQUITONE [pictura]

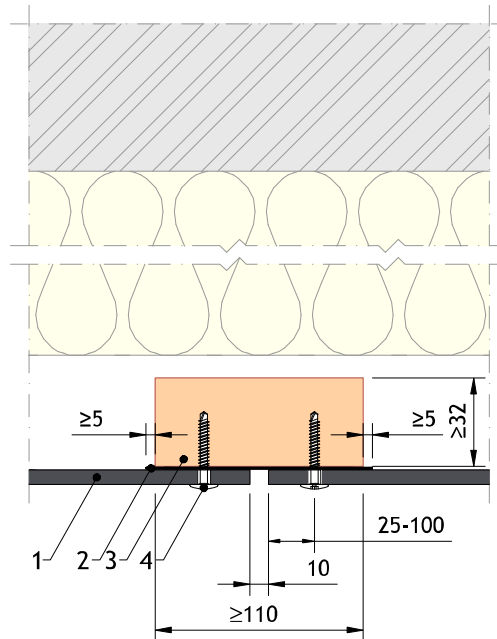
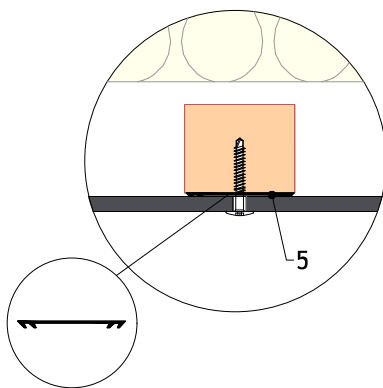
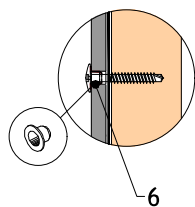

Detail 1 - Vertical joint

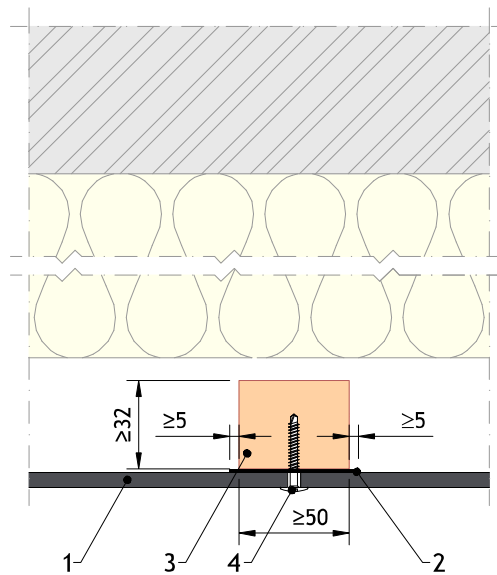

Detail 2 - Intermediate support

Notes:

- 1) Flat EPDM should always overhang the batten by minimum 5 mm at each side.
- 2) In the case of open horizontal joints the ribbed EPDM should cover the batten completely and preferably overhang the batten by 5 mm at each side.
- 3) In case of ribbed EPDM the screw should be located between the ridges.

1. EQUITONE facade panel
2. EPDM
3. Timber support frame
4. UNI-Screw
5. Optional EPDM or flashing<sup>(2)</sup>

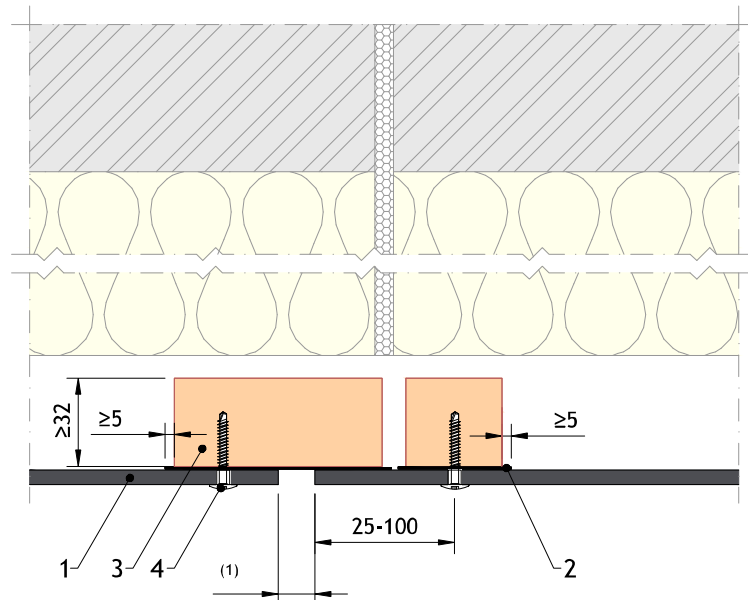

Detail 3 - Vertical control joint

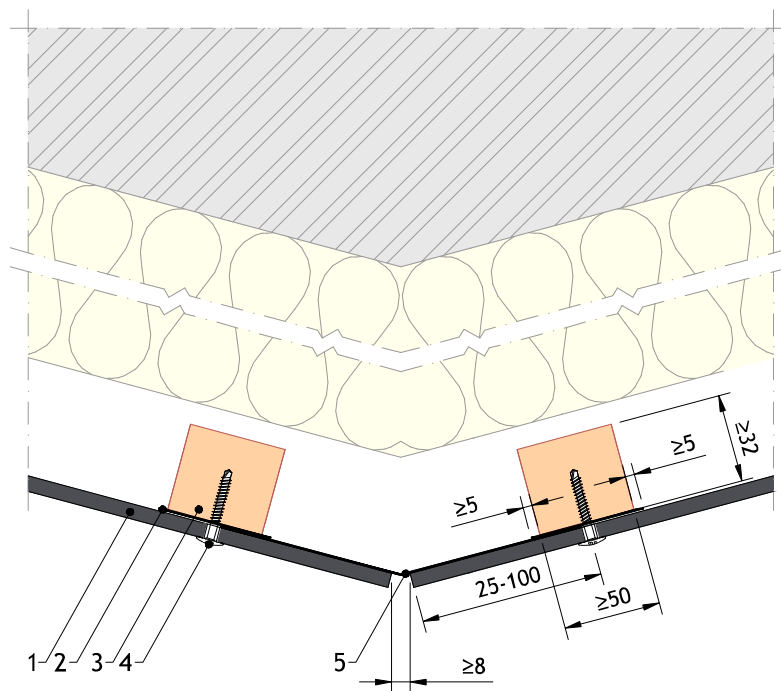

Detail 4 - Vertical joint at angle

Notes:

- 1) The width of the the facade control joint should be equal or greater than the building control joint.
- 2) Flashings to close the joints may not be thicker as 0.8 mm.
- 3) If an EPDM is used to close the joint, the battens must be close to the corner to provide a solid support.

1. EQUITONE facade panel
2. EPDM
3. Timber support frame
4. UNI-Screw
5. Optional horizontal joint profile
6. Screw collar

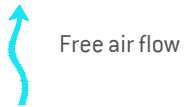

EQUITONE UNI-Screw DP  
with collar  
for EQUITONE [natura] PRO  
and EQUITONE [pictura]

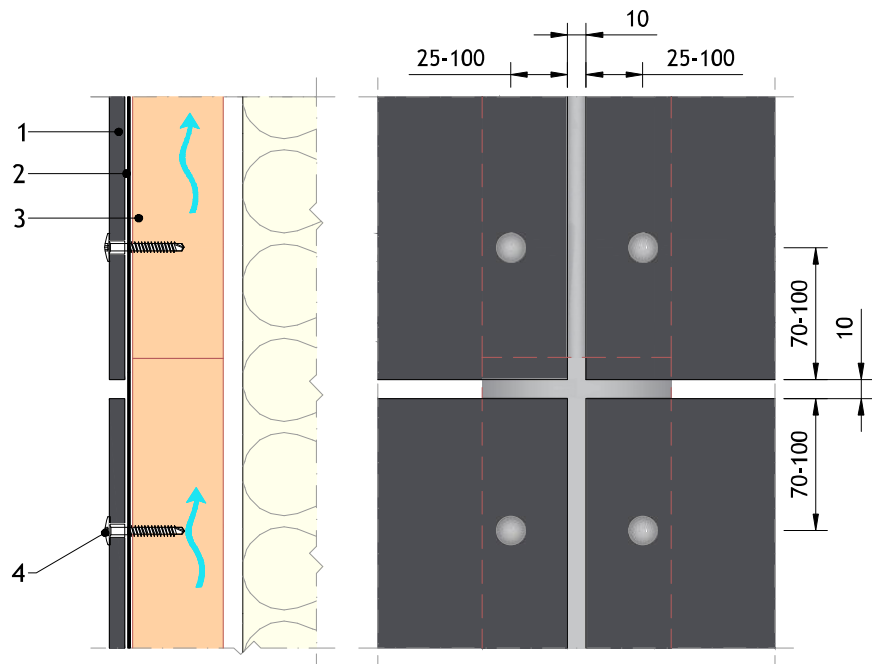
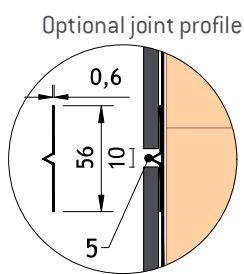
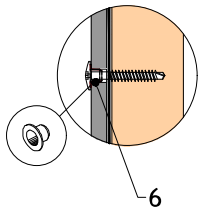

Detail 5 - Open horizontal joint junction with vertical joint

Note:

In the case of open horizontal joints the joint in the timber battens should be behind the upper panel.

1. EQUITONE facade panel
2. EPDM
3. Timber support frame
4. UNI-Screw
5. Optional horizontal joint profile

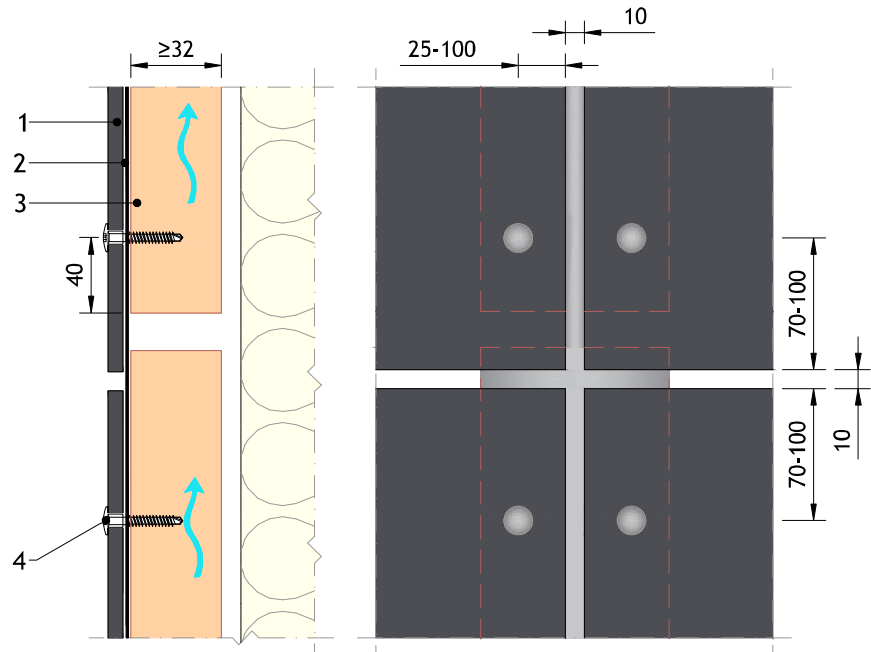
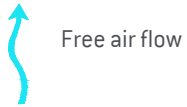

Detail 6 - Open horizontal movement joint

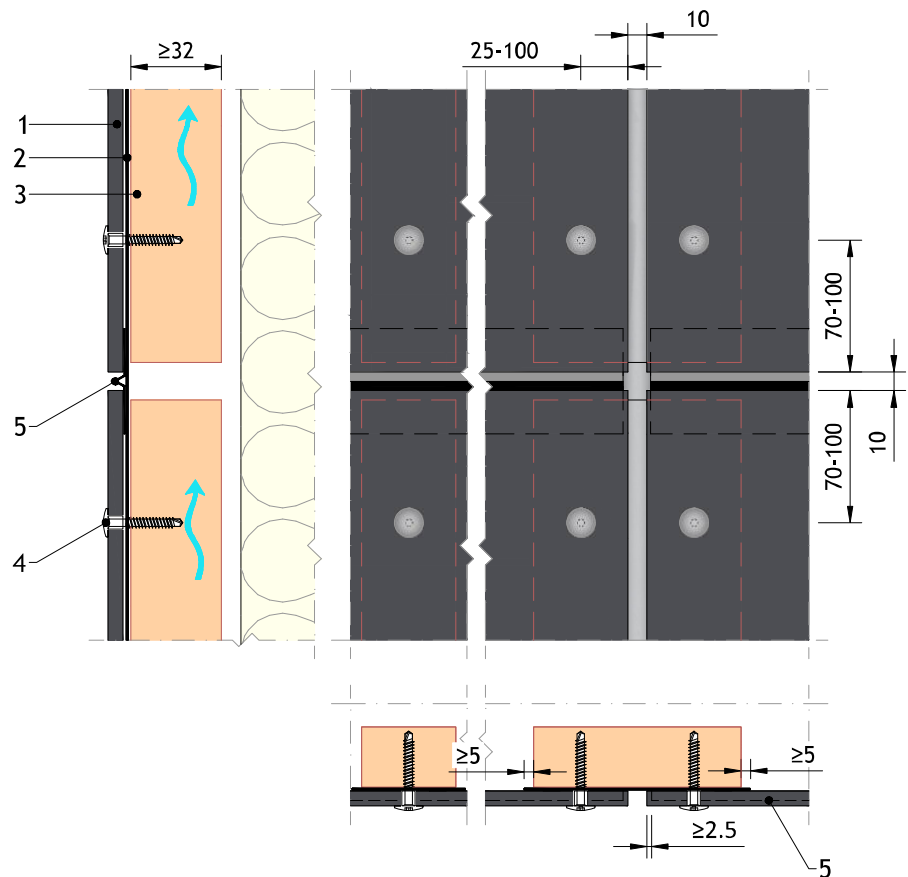

Detail 7 - Baffled horizontal movement joint

1. EQUITONE facade panel
2. EPDM
3. Timber support frame
4. UNI-Screw
5. Perforated closure
6. Skirting<sup>(2)</sup> in EQUITONE [tectiva], EQUITONE [pictura], EQUITONE [textura]
7. Hard insulation suitable for use below ground level

Free air flow

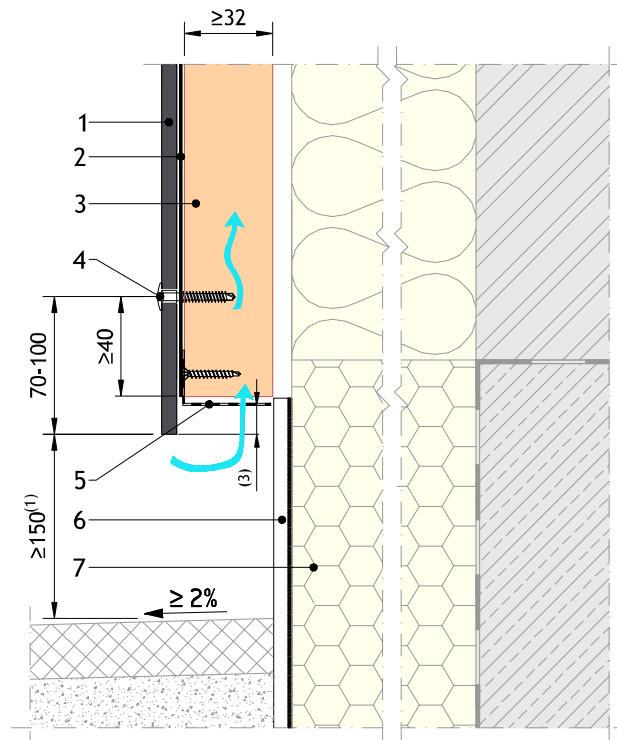
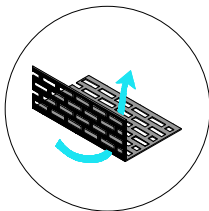
Detail 8 - Base detail – Ground floor

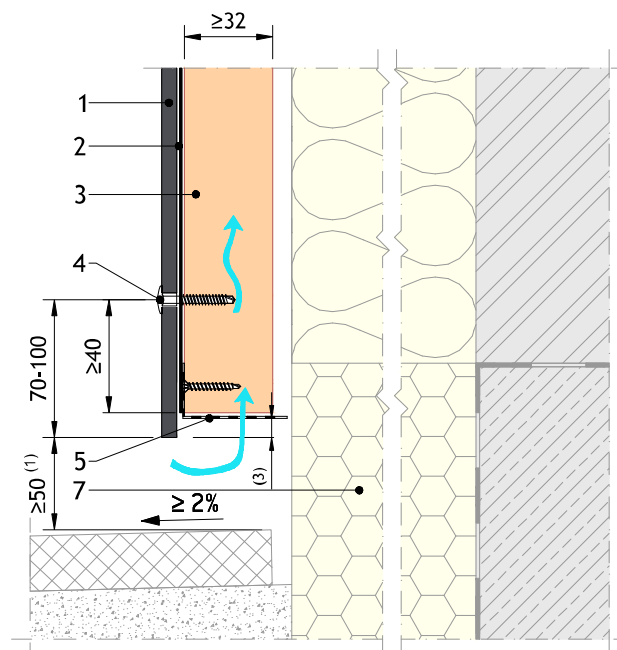

Detail 9 - Base detail – Covered area

Notes:

- 1) The distance to ground level is recommended at minimum 150 mm. A smaller ground clearance is possible, but it may increase the risk of water marks and panel staining caused by splash back.
- 2) The skirting board could be concrete, natural stone, render, metal flashing or EQUITONE.
- 3) The facade panel should preferably overhang more than 10 mm below the ventilation profile to create a drip edge.

1. EQUITONE facade panel
2. EPDM
3. Timber support frame
4. UNI-Screw
5. Perforated closure
6. Balcony floor

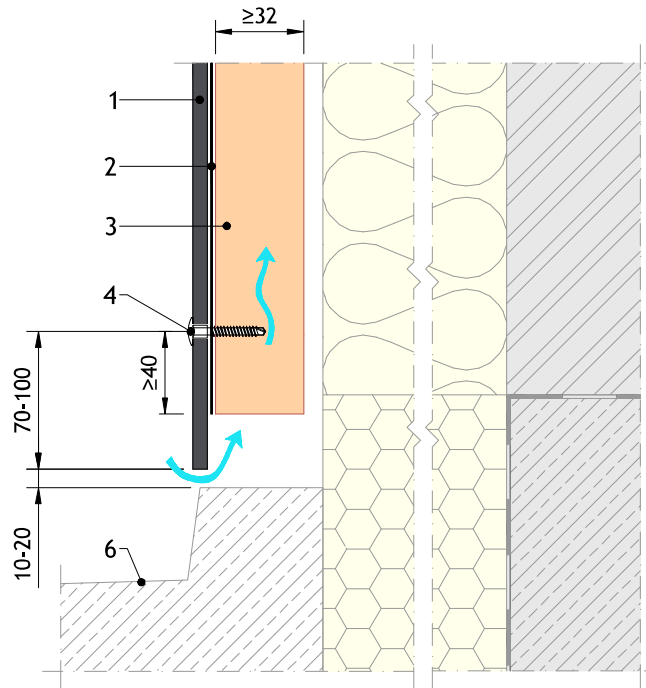
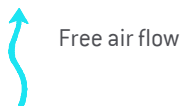

Detail 10 - Base detail – Balcony

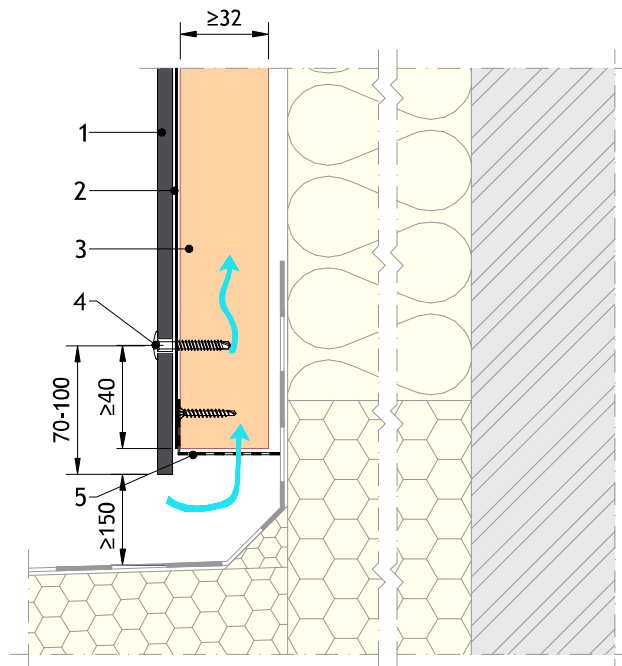
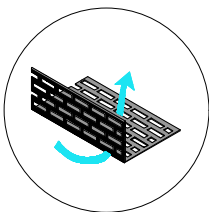

Detail 11 - Base detail – Flat roof abutment / Parapet

1. EQUITONE facade panel
2. EPDM
3. Timber support frame
4. UNI-Screw
5. Perforated closure

Free air flow

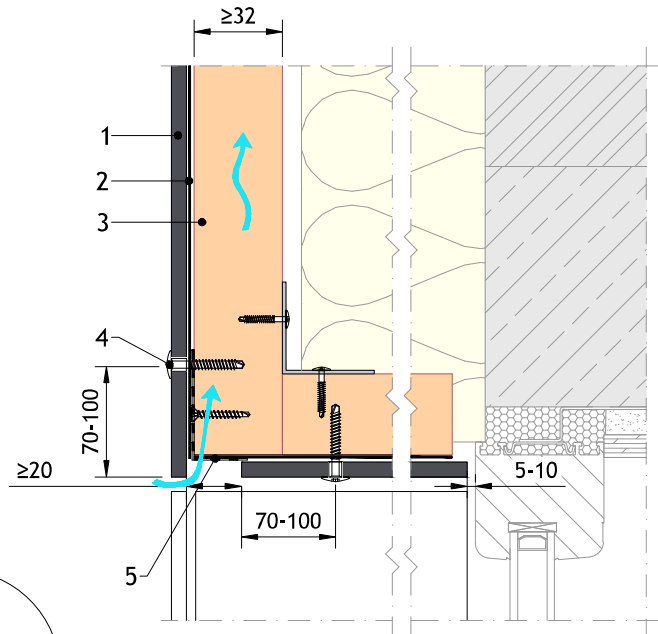
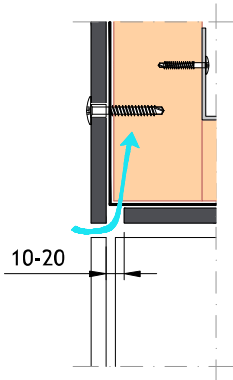
Detail 12 - Window head – Option 1

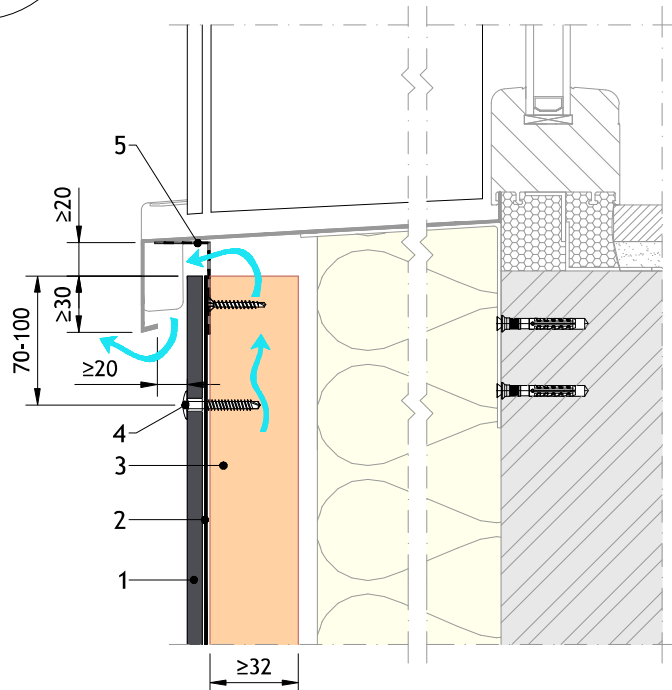
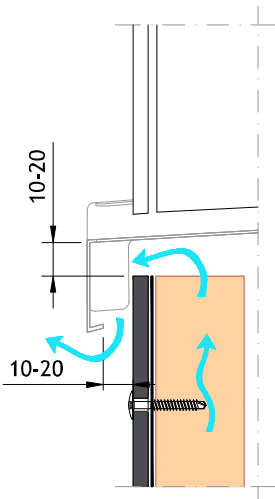
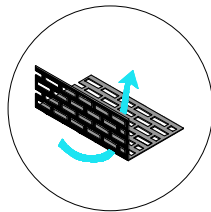

Detail 13 - Window sill – Option 1

Notes:

- 1) When no perforated closure is used at the ventilation inlet, the inlet opening should be between 10 and 20 mm.
- 2) The ventilation inlet should be increased depending on building height and local legislation. When the inlet is wider than 20 mm, a perforated closure is recommended. Total perforation should have a minimum of 100 cm<sup>2</sup>/m.



1. EQUITONE facade panel
2. EPDM
3. Timber support frame
4. UNI-Screw

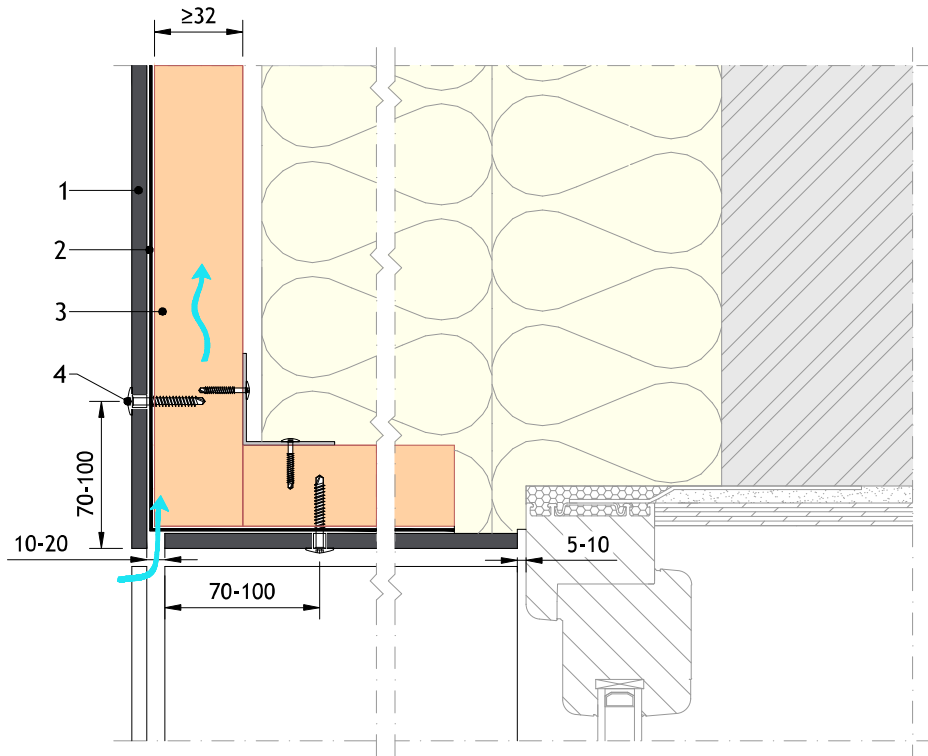
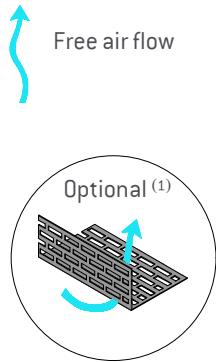

Detail 14 - Window head – Option 2

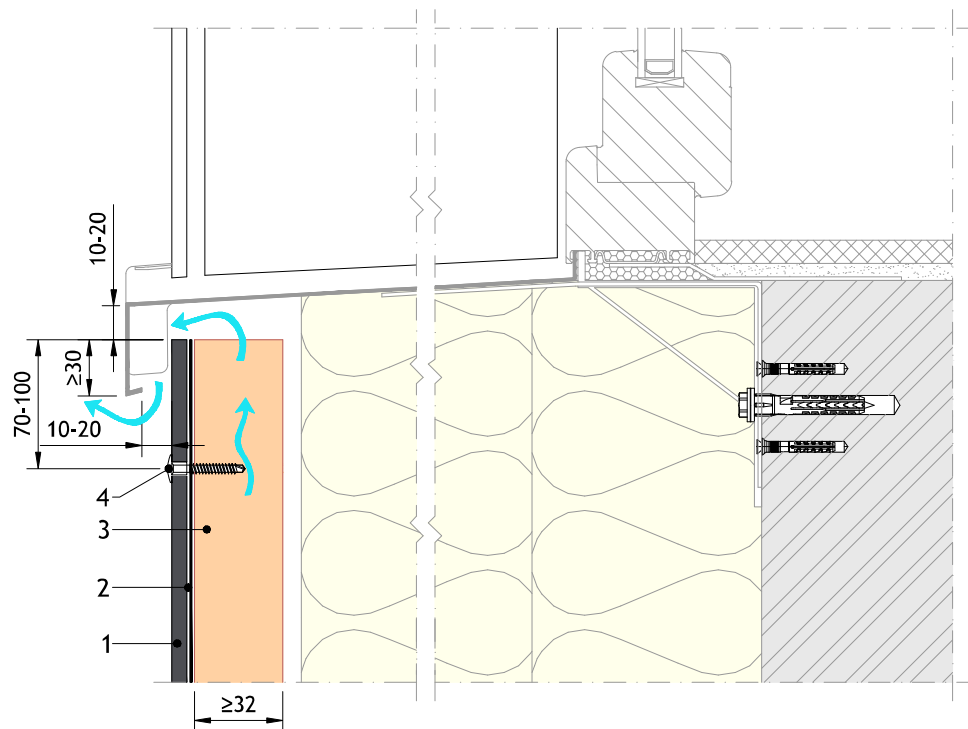

Detail 15 - Window sill – Option 2

Note:

- 1) The ventilation inlet should be increased depending on building height and local legislation. When the inlet is wider than 20 mm, a perforated closure is recommended. Total perforation should have a minimum of 100 cm<sup>2</sup>/m.

1. EQUITONE facade panel
2. EPDM
3. Timber support frame
4. UNI-Screw
5. Aluminium flashing

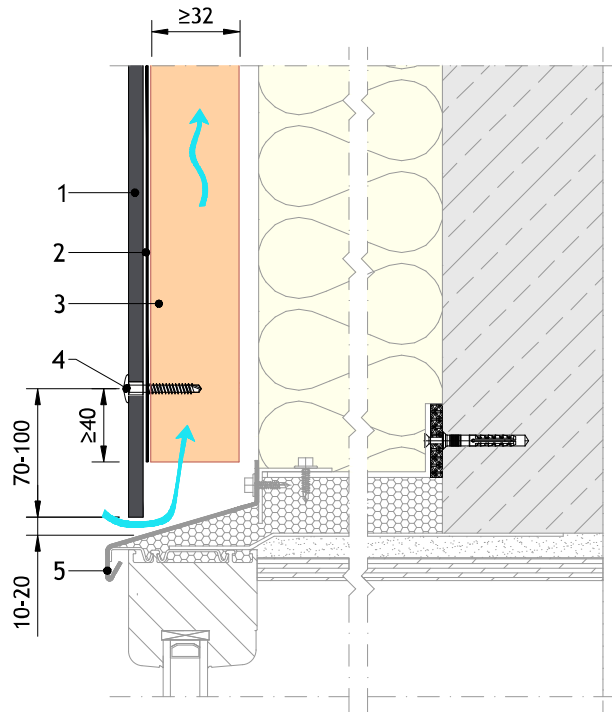
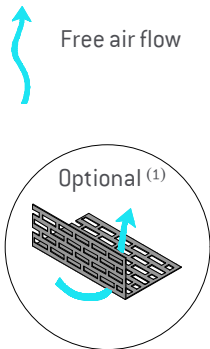

Detail 16 - Window head – Flush window

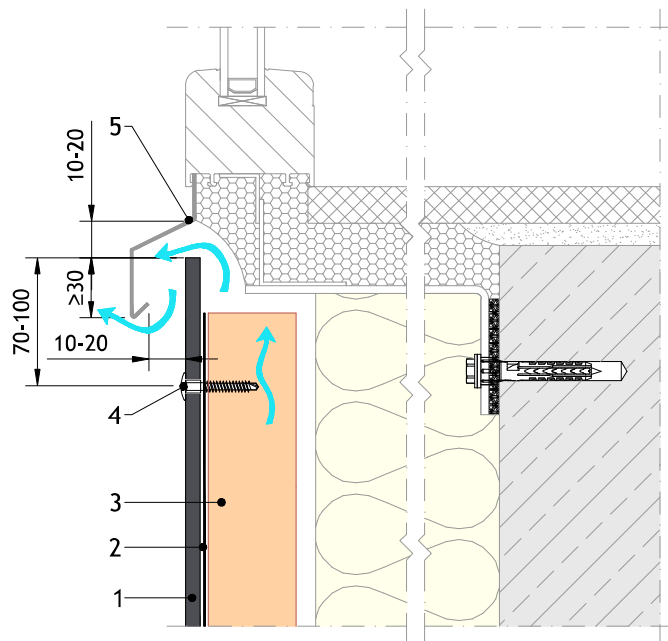

Detail 17 - Window sill – Flush window

Note:

- 1) The ventilation inlet should be increased depending on building height and local legislation. When the inlet is wider than 20 mm, a perforated closure is recommended. Total perforation should have a minimum of 100 cm<sup>2</sup>/m.

1. EQUITONE facade panel
2. EPDM
3. Timber support frame
4. UNI-Screw
5. Perforated closure

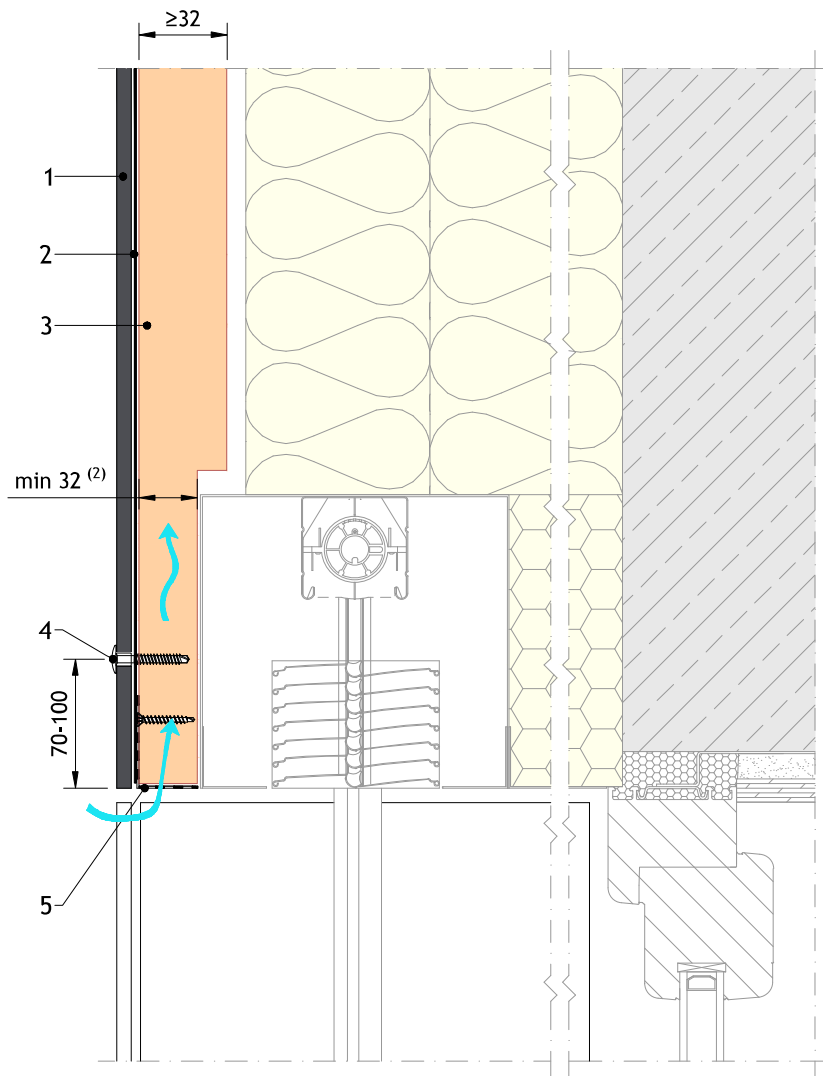
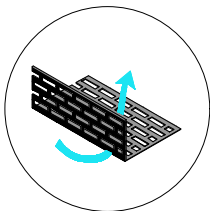
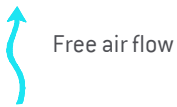

Detail 18 - Window head – With sunscreen

Notes:

- 1) The ventilation inlet should be increased depending on building height and local legislation. When the inlet is wider than 20 mm, a perforated closure is recommended. Total perforation should have a minimum of 100 cm<sup>2</sup>/m.
- 2) The reduced section of the support battens must be taken into account during static calculations.

1. EQUITONE facade panel
2. EPDM
3. Timber support frame
4. UNI-Screw
5. Perforated closure

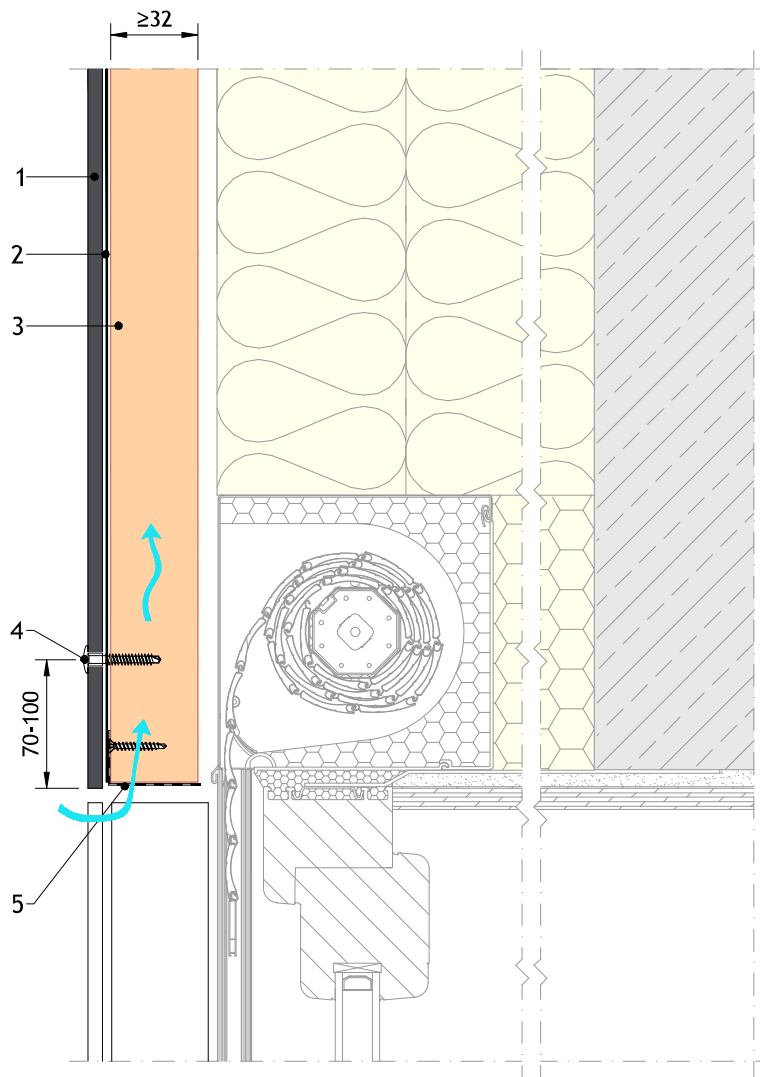
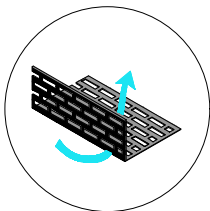
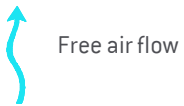

Detail 19 - Window head – With shutter

Note:

The ventilation inlet should be increased depending on building height and local legislation. When the inlet is wider than 20 mm, a perforated closure is recommended. Total perforation should have a minimum of 100 cm<sup>2</sup>/m.

1. EQUITONE facade panel
2. EPDM
3. Timber support frame
4. UNI-Screw

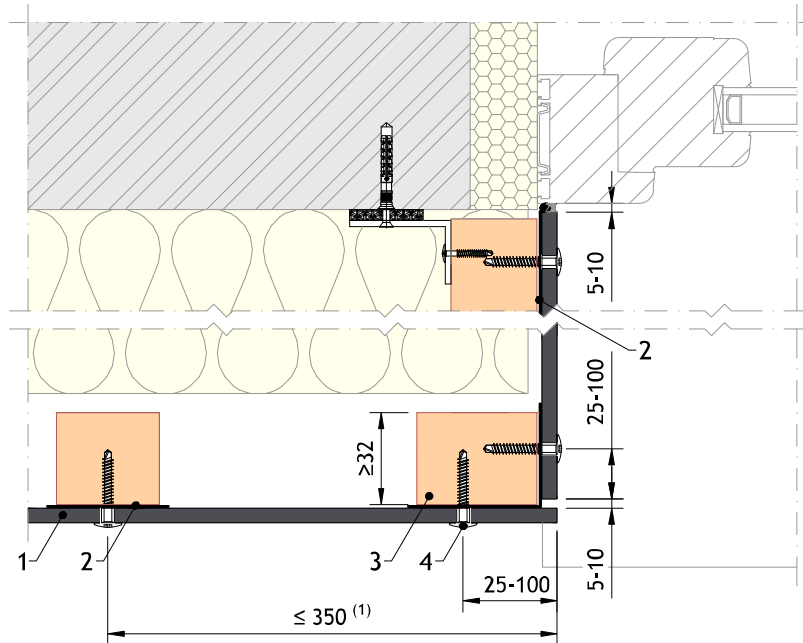

Detail 20 - Window jamb – Option 1

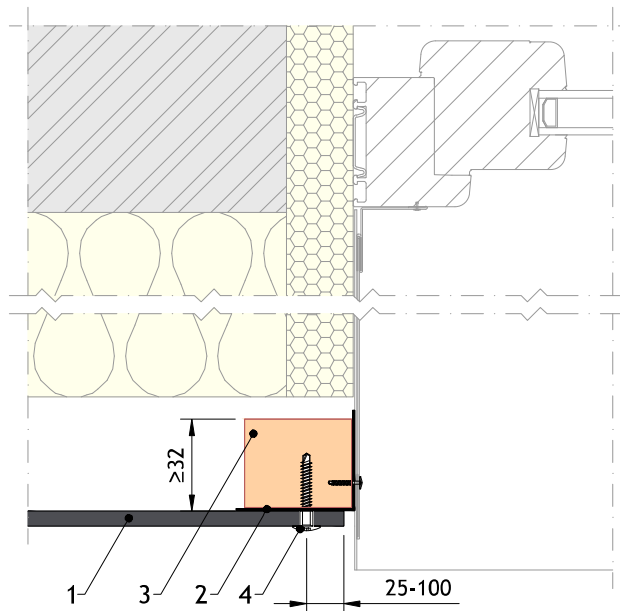

Detail 21 - Window jamb – Metal flashing

Note:

- 1) Panels with single span (panels with 2 columns of fixings) cannot be fixed to a floating angle like shown in the detail.

1. EQUITONE facade panel
2. EPDM
3. Timber support frame
4. UNI-Screw

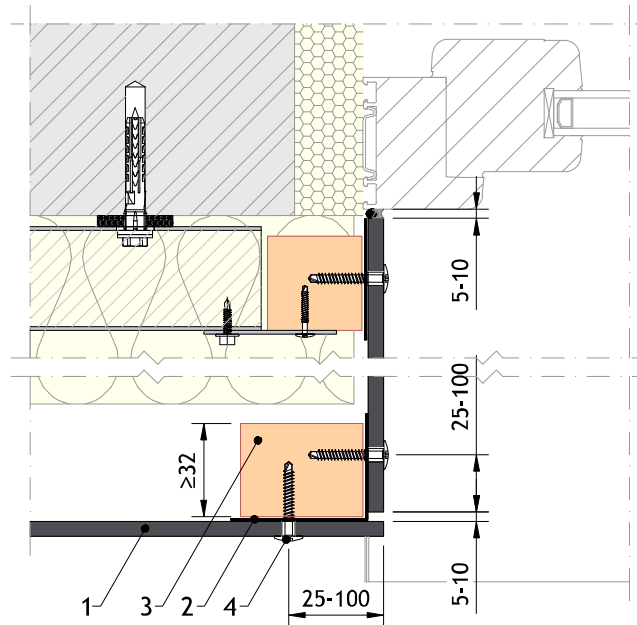

Detail 22 - Window jamb – Option 2

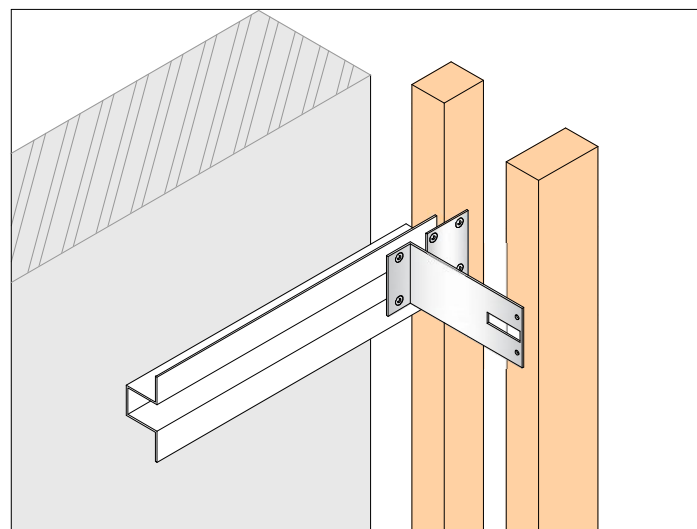

Isometric view of the support frame

1. EQUITONE facade panel
2. EPDM
3. Timber support frame
4. UNI-Screw

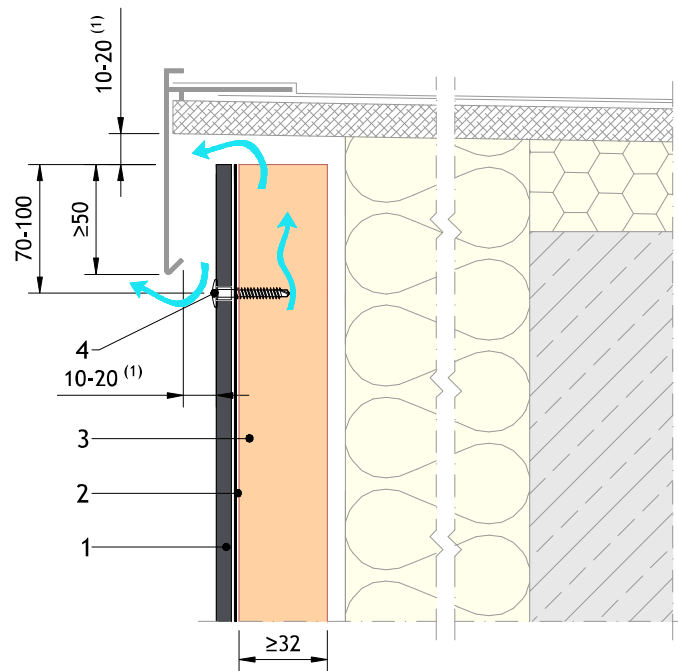
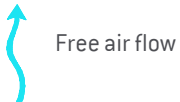

Detail 23 - Capping

## Notes:

- 1) When perforated closures are used underneath the capping the ventilation outlet opening between panel and capping should be a minimum of 30 mm.
- 2) The ventilation inlet should be increased depending on building height and local legislation. When the inlet is wider than 20 mm, a perforated closure is recommended. Total perforation should have a minimum of 100 cm<sup>2</sup>/m.

1. EQUITONE facade panel
2. EPDM
3. Timber support frame
4. UNI-Screw
5. Counter batten

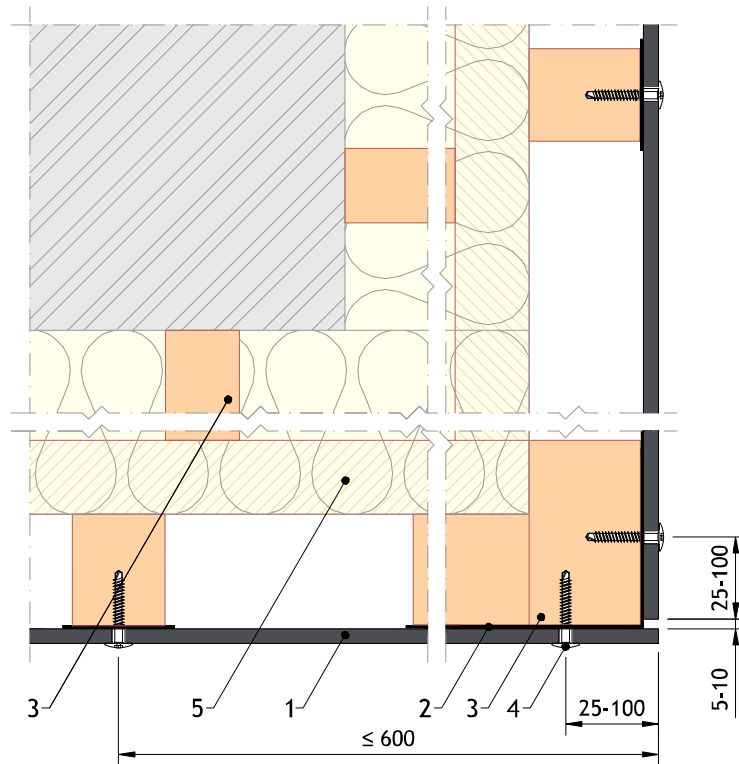

Detail 24 - External corner

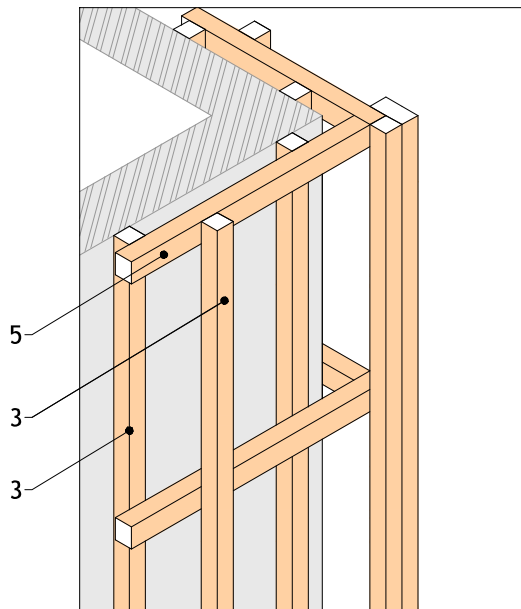

Isometric view of the support frame



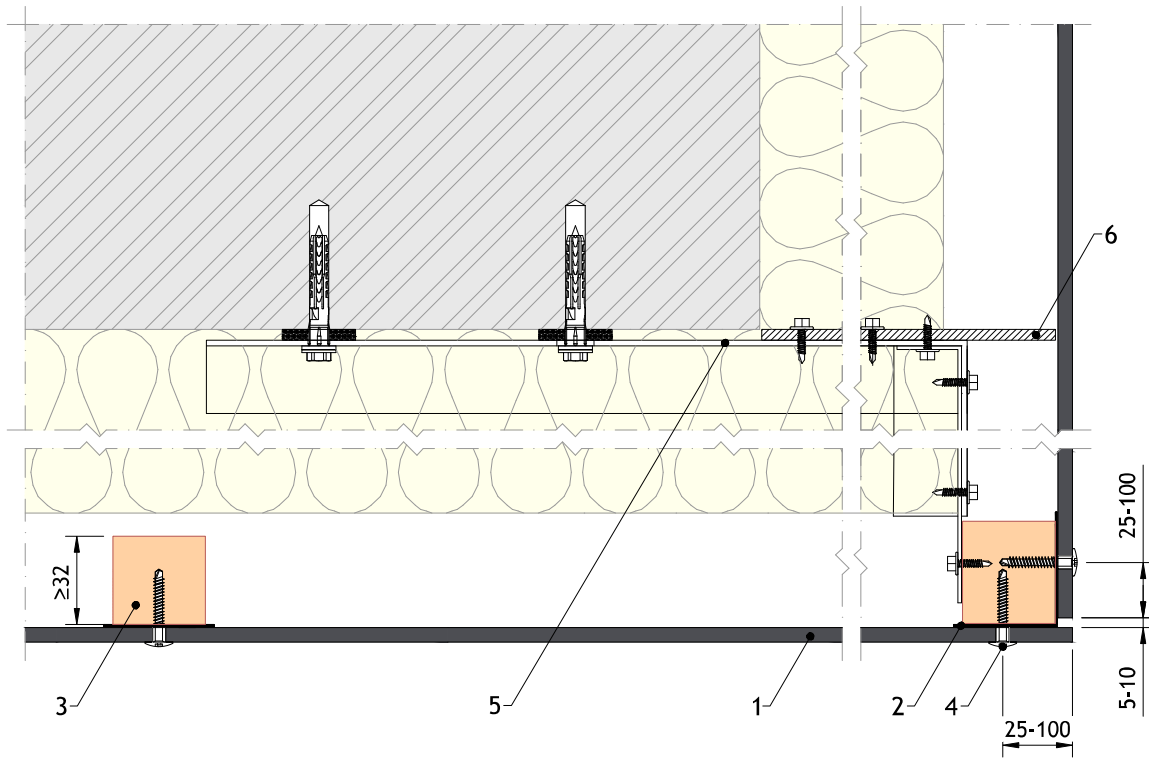

Detail 25 - External corner with wind barrier

- 1. EQUITONE facade panel
- 2. EPDM
- 3. Timber support frame
- 4. UNI-Screw
- 5. Metal bracket system
- 6. Wind barrier [metal or fibre-cement]

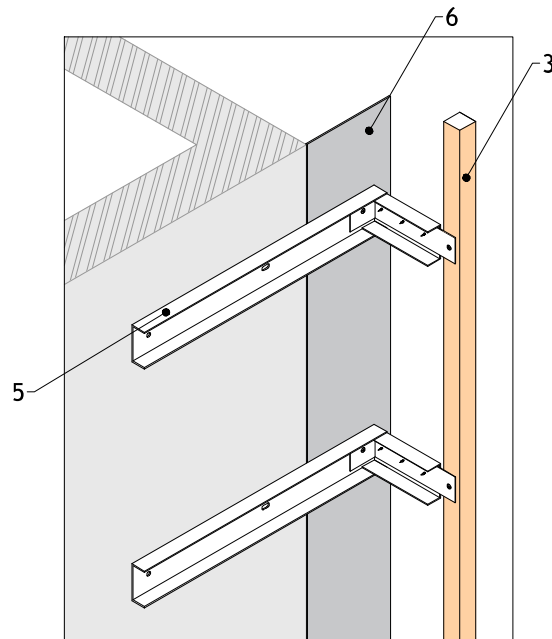

Isometric view of the support frame

Note:

The installation of wind barrier is subject to local standards and building regulation.

1. EQUITONE facade panel
2. EPDM
3. Timber support frame
4. UNI-Screw

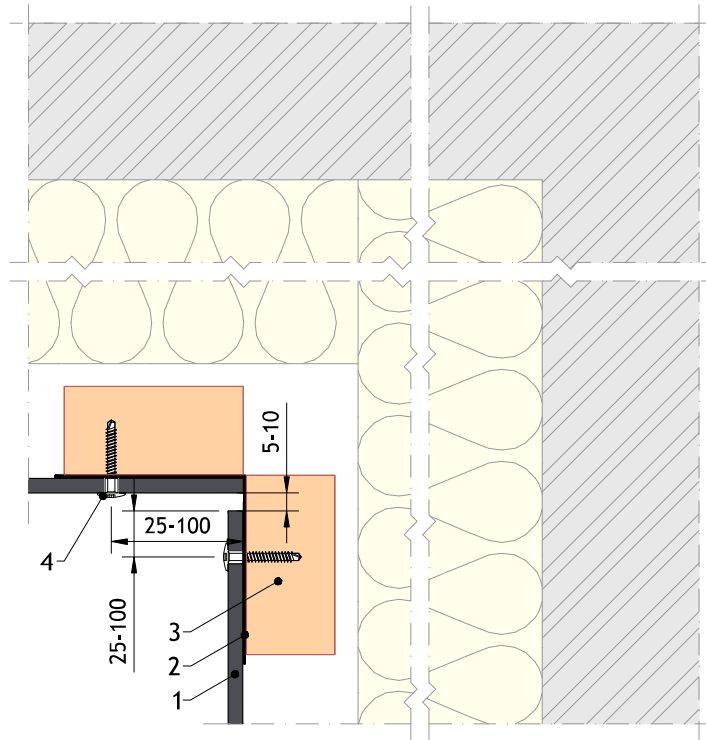

Detail 26 - Internal corner

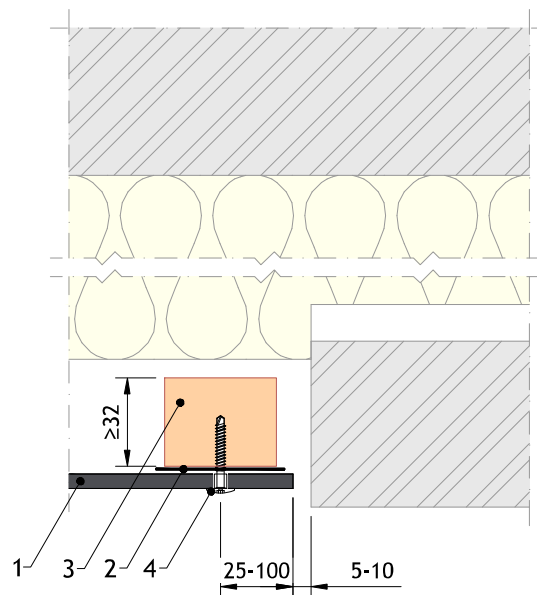

Detail 27 - Abutment

1. EQUITONE facade panel
2. EPDM
3. Timber support frame
4. UNI-Screw
5. Perforated closure
6. Aluminium flashing
7. Adjacent facade system

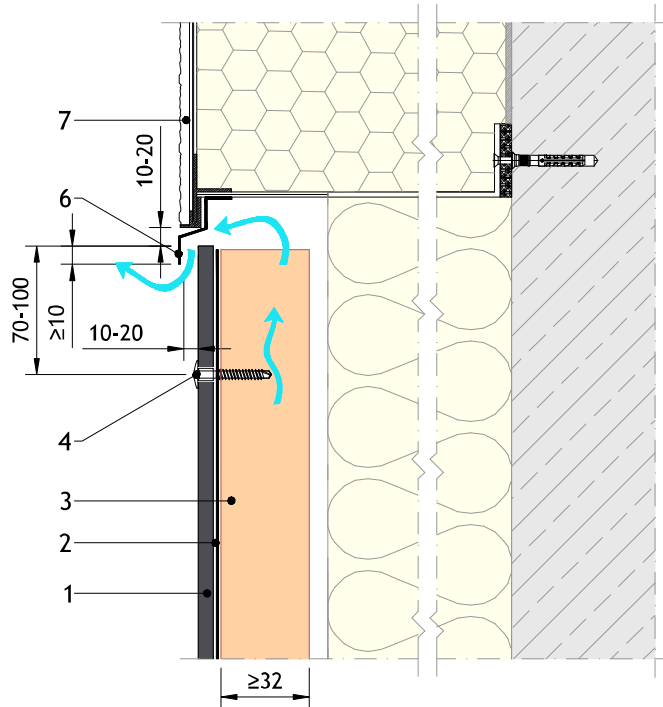
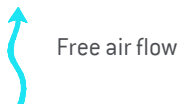

Detail 28 - Junction with other facade material – Head detail

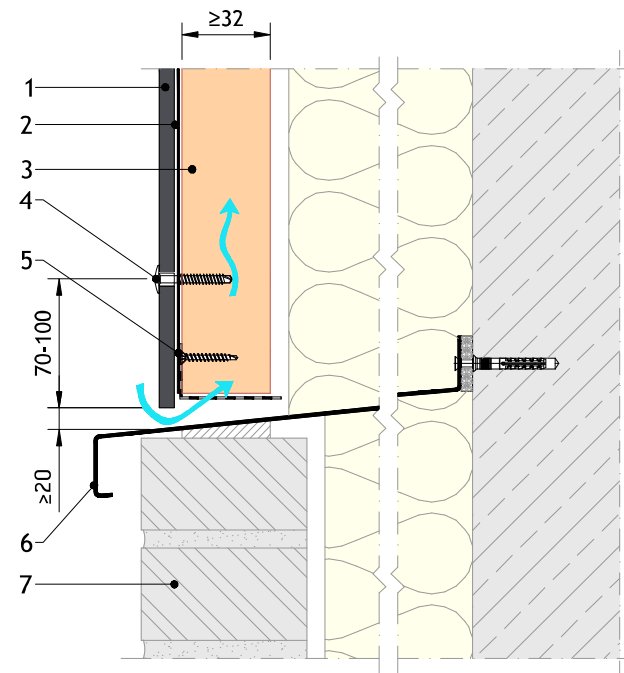
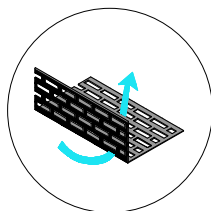

Detail 29 - Junction with other facade material – Base

Note:

The ventilation inlet should be increased depending on building height and local legislation. When the inlet is wider than 20 mm, a perforated closure is recommended. Total perforation should have a minimum of 100 cm<sup>2</sup>/m.

1. EQUITONE facade panel
2. EPDM
3. Timber support frame
4. UNI-Screw
5. Optional EPDM or flashing<sup>(3)</sup>

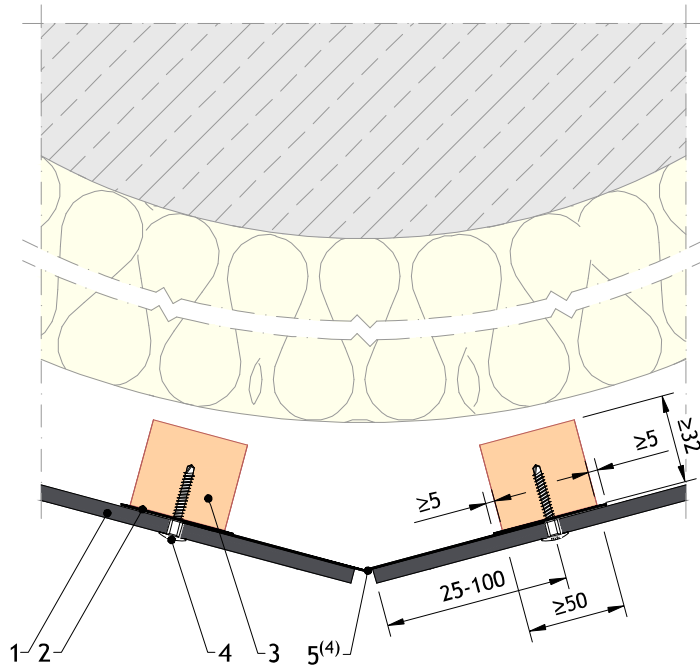

Detail 30 - Segmented façade – Radius < 12 m

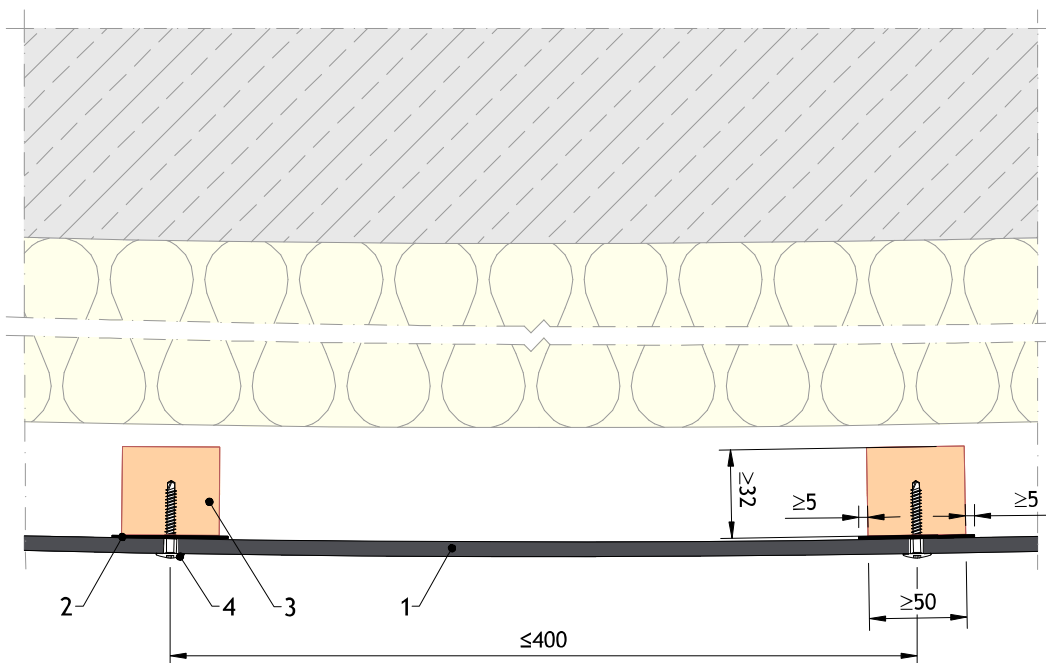

Detail 31 - Curved façade – Radius ≥ 12 m

Notes:

- 1) The minimum radius for curved facade is 12.0 m, the framing centers should be reduced to a maximum of 400 mm.
- 2) For smaller radii the facade should be executed as segmented facade.
- 3) Flashings to close the joints may not be thicker than 0.8 mm.
- 4) If an EPDM is used to close the joint, the battens must be close to the corner to provide a solid support.

1. EQUITONE facade panel
2. EPDM
3. Timber support frame
4. UNI-Screw
5. Perforated closure

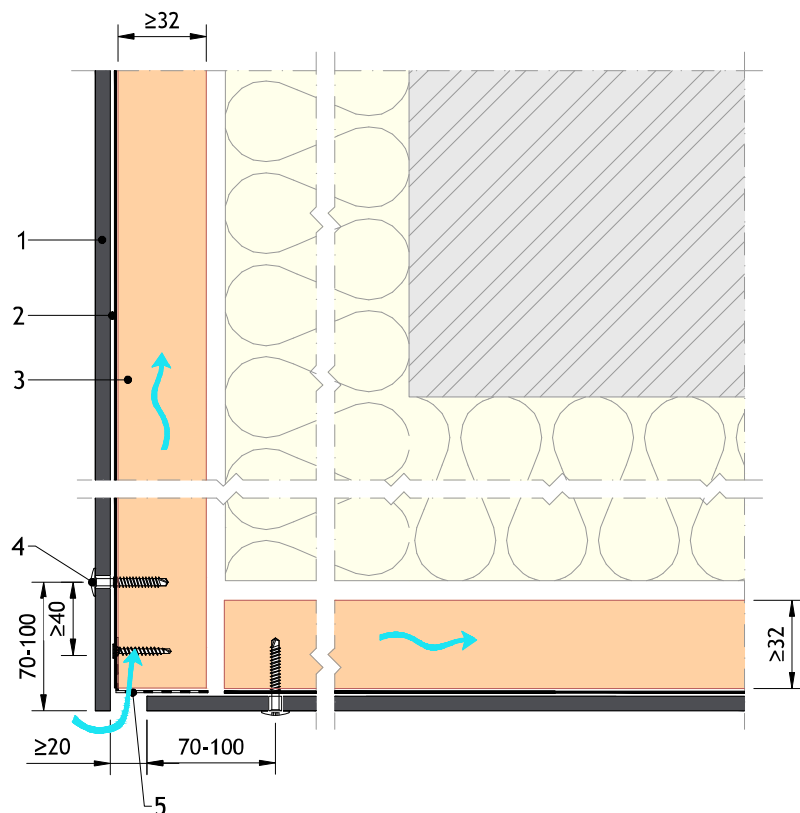
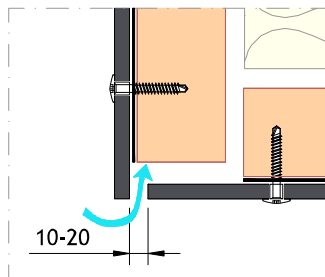
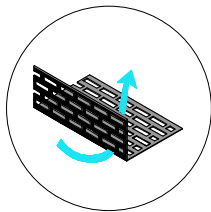
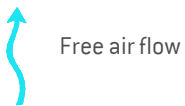

Detail 32 - Soffit/ceiling-wall junction

Notes:

- 1) The maximum centre-spacing between the UNI-Screws in a ceiling application is 400 mm.
- 2) When no perforated closure is used at the ventilation inlet, the inlet opening should be between 10 and 20 mm. Total perforation should have a minimum of 100 cm<sup>2</sup>/m.
- 3) The ventilation inlet should be increased depending on building height and local legislation. When the inlet is wider than 20 mm, a perforated closure is recommended.

1. EQUITONE facade panel
2. EPDM
3. Timber support frame
4. UNI-Screw

Free air flow

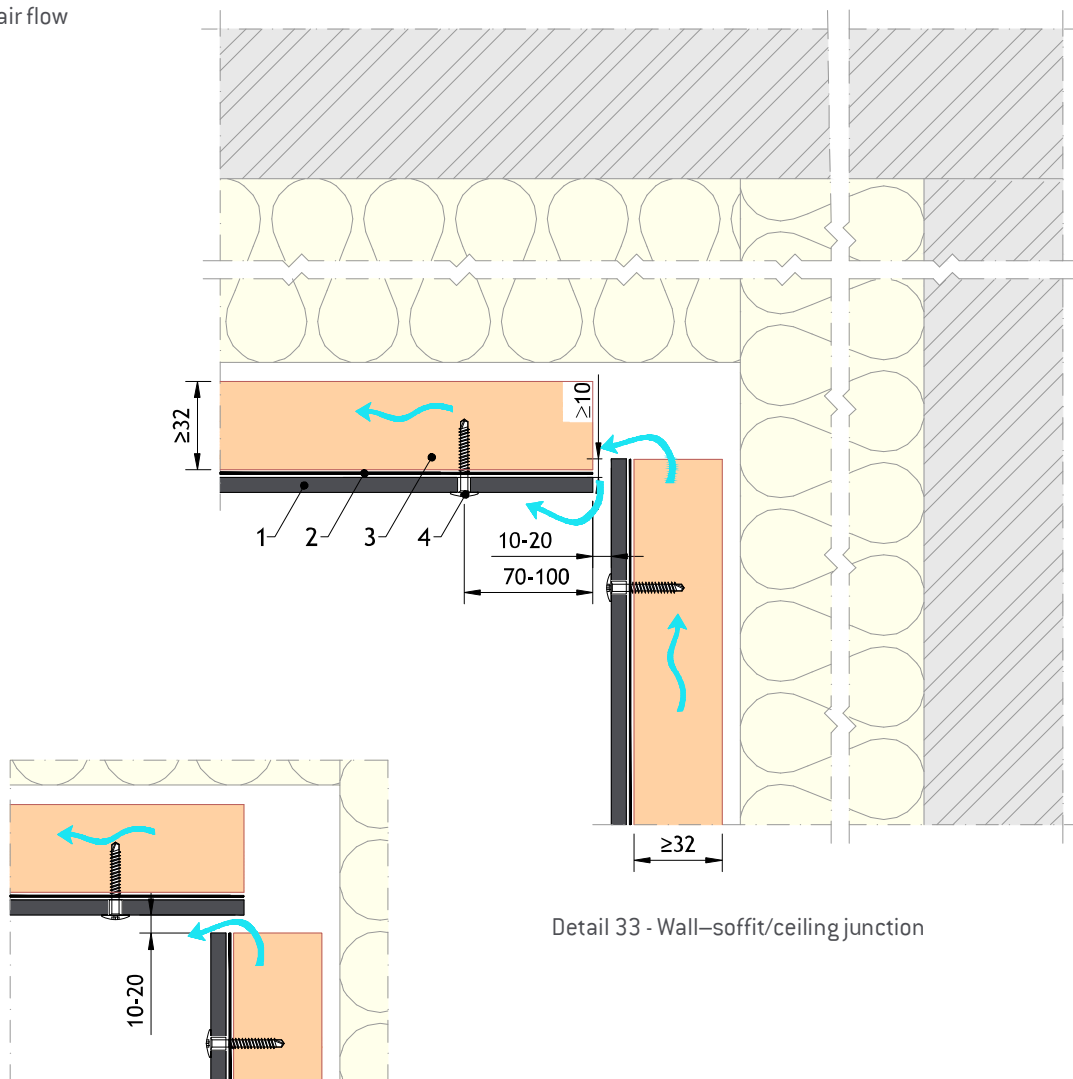



Detail 33 - Wall-soffit/ceiling junction

Notes:

- 1) The maximum centre-spacing between the UNI-Screws in a ceiling application is 400 mm.
- 2) When no perforated closure is used at the ventilation inlet, the inlet opening should be between 10 and 20 mm. Total perforation should have a minimum of 100 cm<sup>2</sup>/m.
- 3) The ventilation inlet should be increased depending on building height and local legislation. When the inlet is wider than 20 mm, a perforated closure is recommended.

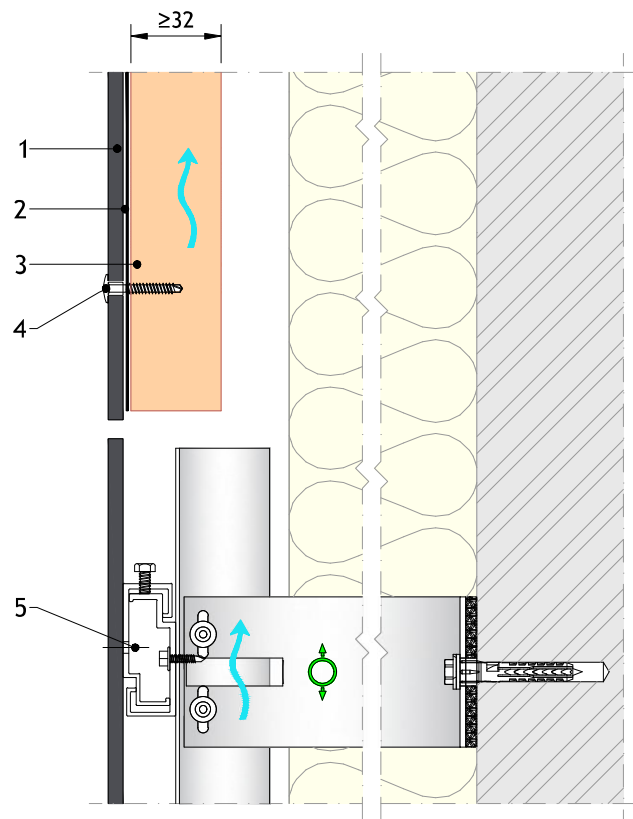
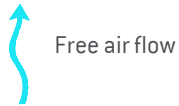
1. EQUITONE facade panel
2. EPDM
3. Timber support frame
4. UNI-Screw
5. Concealed fixing system



Detail 34 - Junction with panels with concealed fixings

Notes:

- 1) Check the construction details for concealed fixing for more information.
- 2) Depending on the specified concealed fixing system the minimum panel thickness could vary from 8 to 12 mm as applicable.
- 3) Special attention must be taken to the alignment of the panels with concealed fixing and the ones with face fixings.

---

#### Disclaimer

The information in this document is correct at time issuing. However, due to our committed program of continuous material and system development we reserve the right to amend or alter the information contained therein without prior notice. Please visit [www.equitone.com](http://www.equitone.com) to ensure you have the most current version. All figures contained in this document are illustrations and should not be used as construction drawings. This information is supplied in good faith and no liability can be accepted for any loss or damage resulting from its use. This document is protected by international copyright laws. Reproduction and distribution in whole or in part without prior written permission is strictly prohibited. EQUITONE and logos are trademarks of Etex NV or an affiliate thereof. Any use without authorisation is strictly prohibited and may violate trademark laws.



[www.equitone.com](http://www.equitone.com)