

[Go to Content](#)

Content	Detail No.	Page
General information		3
Components		4
Support frame		7
Ventilation		8
Vertical joint at top rail	1	10
Intermediate panel hanger	2	10
Vertical control joint	3	11
Vertical joint at angle	4	11
Fixed and gliding points of support frame	5	12
Open horizontal joint junction with vertical joint	6	13
Base detail – Ground floor	7	14
Base detail – Covered area (not exposed to precipitation)	8	14
Base detail – Balcony	9	15
Base detail – Flat roof abutment / Parapet	10	15
Window head – Option 1	11	16
Window sill – Option 1	12	16
Window head – Option 2	13	17
Window sill – Option 2	14	17
Window head – Flush window	15	18
Window sill – Flush window	16	18
Window head – With sunscreen	17	19
Window head – With shutter	18	20
Window jamb – Metal flashing	19	21
Window jamb	20	22
Capping	21	23
Capping – Hidden ventilation	22	23
External corner	23	24
External corner with wind barrier	24	25
Internal corner	25	26
Abutment	26	26
Junction with other facade material – Head detail	27	27
Junction with other facade material – Base	28	27
Segmented façade	29	28
Soffit/ceiling–wall junction	30	29
Wall–soffit/ceiling junction	31	30
Junction with panels with face fixings	32	31

## General information

This document provides generic construction details for EQUITONE façade systems with concealed panel fixings to assist with the design of EQUITONE façade.

This document is not designed to serve as an installation guide and is intended to be used in conjunction with the relevant EQUITONE Planning and Application Guide and other technical and installation documents.

The details included in this document only illustrate general principles for detailing of EQUITONE at different typical interfaces; and are not to be relied upon for weatherproofing and fire safety compliance with local regulations. The weatherproofing and fire performance of any project specific detail or application shall be evaluated by the project engineer or consultant.

Any components related to wind barriers, fire safety, moisture management and weather proofing including but not limited to membranes, flashings, water seals and sealants, airtightness tapes, horizontal and/or vertical fire barriers, etc, will need to be applied according to local regulations, project requirements and relevant standards.

The support frame, fixings, flashings, and the like shall be of adequate corrosion resistance appropriate to the corrosivity category of the project location.

All dimensions in this document are in millimetre (mm).

The information in this guide is comprehensive but not exhaustive, and the reader will need to satisfy themselves that the contents of this guide are suitable for their intended application. It is the responsibility of the project consultants (designer, architect, and engineers) to ensure that the information and details provided in this document are appropriate for the project.

The information in this document is correct at the time of issuing. However, due to our committed program of continuous material and system development we reserve the right to amend or alter the information contained in this document without prior notice. Please visit [www.equitone.com](http://www.equitone.com) to ensure you have the most current version.

This document is supplied in good faith and no liability can be accepted for any loss or damage resulting from its use. Images and construction details contained in this document are not to a specific scale, are indicative and for illustration purposes only and should not be used as final construction drawings.

This document is protected by international copyright laws. Reproduction and distribution in whole or in part without prior written permission is strictly prohibited. EQUITONE and logos are trademarks of Etex NV or an affiliate thereof. Any use without authorisation is strictly prohibited and may violate trademark laws.



Please visit [www.equitone.com](http://www.equitone.com) for contact details and further information and technical documents.

# Components

## Materials



EQUITONE [linea]

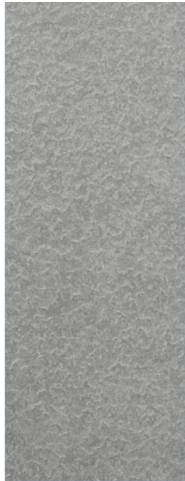

EQUITONE [lunara]



EQUITONE [tectiva]



EQUITONE [natura],  
[natura] PRO



EQUITONE [pictura]



EQUITONE [textura]

## Maximum usable panel sizes

EQUITONE [linea]  
EQUITONE [lunara]  
EQUITONE [tectiva]

10 mm  
10 mm  
8 and 10 mm

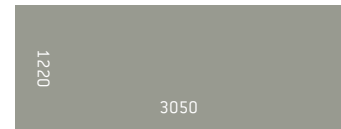

EQUITONE [natura]  
EQUITONE [natura] PRO  
EQUITONE [pictura]  
EQUITONE [textura]

8 and 12 mm  
8 and 12 mm  
8 and 12 mm  
8 and 12 mm

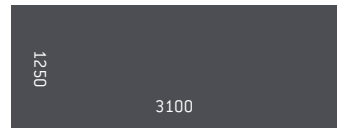
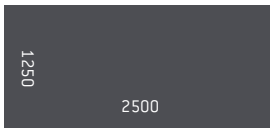

[Go to Content](#)

**Panel fixings**

SFS I TUF-S anchor  
 Stainless Steel 316 - grade A4  
 Material number 1.4401

Refer to Concealed fixing Planning and Application Guide for further information.  
 SFS TUF-S is available in various sizes suiting different panel thicknesses.  
 Panel edge distance: 50 mm to 100 mm  
 Each panel hanger is fixed with 2 SFS TUF-S fixings respecting 30 mm centre distance



For 8 mm and 10 mm EQUITONE panels

Anchor type	Embedment depth (mm)
TUF-S-6xL	5.5
TUF-S-6xL	5.0

For 12 mm EQUITONE panels

Anchor type	Embedment depth (mm)
TUF-S-6xL	8.5

The length of the anchor is determined as follows: L = embedment depth + hanger thickness.  
 E.g., 5,5 mm + 3,5 mm = 9,0 mm

Fischer I FZP-K undercut anchor (Tergo+)  
 Stainless Steel 316 - grade A4  
 Material number 1.4401

Refer to Concealed fixing Planning and Application Guide for further information.  
 FZP-K is available in various sizes with different washer colours suiting different panel thicknesses. The locknut is included.  
 Panel edge distance: 50 mm to 100 mm



For 8 mm and 10 mm EQUITONE panels

Anchor type	Colour washer	Embedment depth (mm)	Thread length
FZP-K-T 11x6 M6/T/10 PA	red	6	10
FZP-K-T 11x6 M6/T/13 PA	red	6	13

For 12 mm EQUITONE panels

Anchor type	Colour washer	Embedment depth (mm)	Thread length
FZP-K-T 11x8 M6/T/10 PA	yellow	8	10
FZP-K-T 11x8 M6/T/13 PA	yellow	8	13

Note  
 The standard thread length of 10 mm will suit most applications. The longer bolt of 13 mm is used when a bigger clamping range is required.

Keil I Tergo undercut anchor  
 Stainless Steel 316L - grade A4  
 Material number 1.4404

Refer to Concealed fixing Planning and Application Guide for further information.  
 Keil I Tergo undercut anchor is available for 12 mm thick panels.  
 Edge distance: 100 mm



For 12 mm EQUITONE panels

Anchor type	Panel insertion depth (mm)
Ø8/10mm - M6x10,5	h <sub>s</sub> =8,0

[Go to Content](#)**Panel hanger**

Aluminium hangers are fixed onto rear of EQUITONE panel with special concealed fixings. There are two types of hangers – a standard one & an adjustable one.

The latter only applies to the top row panel fixings (hangers) and allows perfect levelling of the panel.

The shape of the hanger depends on the type of concealed anchor (diameter, number, and shape of hole).

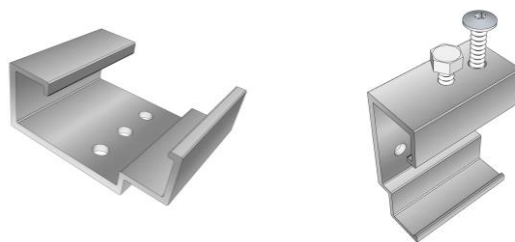
**Horizontal rails**

Aluminium horizontal rails onto which EQUITONE panel is mounted. The rails have to be fixed according the fixed and gliding points principle (only one fixed point per rail).

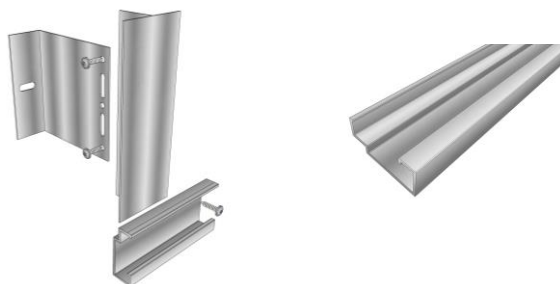
**Position of fixed and gliding points**

The configuration of the panel hangers on each panel must comply with the following principle.

Two adjustable panel hangers on both ends of the top row of hangers that allow perfect levelling of the panel. These two hangers will take the full dead load of the panel. One of these hangers shall also serve as a horizontal fixed point to prevent movement. The fixed point should be executed according the sub construction manufacturer guidelines. The fixed-point panel hanger should always be on the same location in all panels of a facade, they could be all on the left side or all on the right side of the panels.

All other hangers are standard hangers and will be subjected to wind load only.

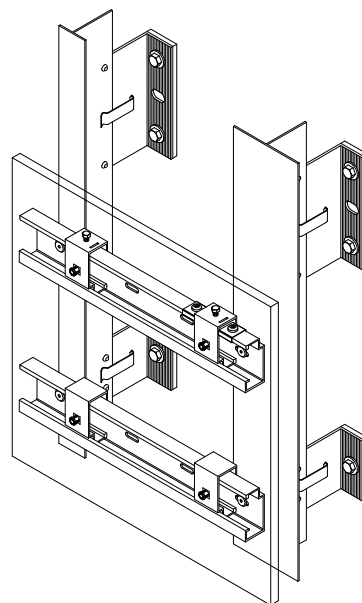
**Perforated Closure**

Aluminium perforated profile used to close the cavity entry and outlet to prevent the entry of birds and vermin.

Available in four different widths to suit a range of cavity thicknesses and two different colours: uncoated aluminium and black coated aluminium.

The perforation rate is approximately 35 %.



## Support frame

The construction details in this document are shown as an example with aluminium T- and L-profiles.

Vertical profiles

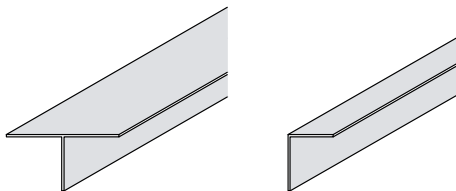

Gliding point bracket

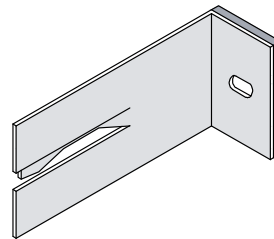

Fixed point bracket

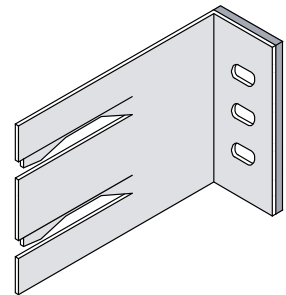

### Other shapes of profiles

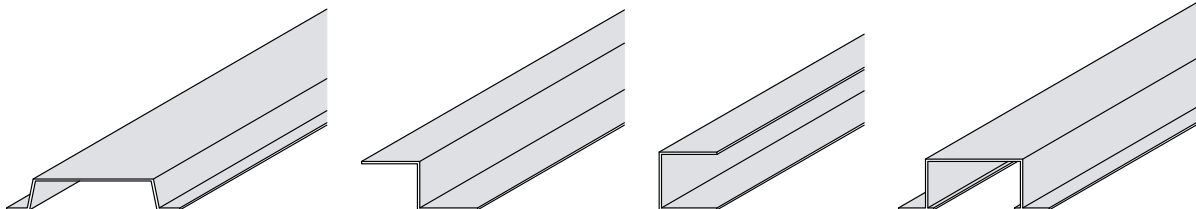

The cladding support frame and its connection to the substructure shall be designed and selected by the project engineer in accordance with the relevant standards. The support frame maximum deflection under the influence of load shall be limited to  $\text{Span}/300$  with a maximum of 4 mm.

## Ventilation

A ventilated façade is a kind of two stage construction, an inner structure with a protective outer skin, and the cladding panel or rainscreen. A ventilated façade consists of an insulated and weathertight structure, a ventilated cavity formed with a cladding support frame and the cladding panel.

The bare minimum clear gap (cavity width) for ventilation behind the panels is 20 mm and may need to be increased based on the vertical distance between ventilation inlet and outlet. Typical cavity width will be governed by the framing dimensions and be approximately 30 to 60 mm.

Air must be allowed to enter the cavity from bottom of the façade, window head, soffit, slab junctions, and the like, and exit from top of the façade, capping, window sill, slab and soffit interfaces, and the like.

The size of inlets and outlets should be executed as stipulated in this document and the Planning & Application Guide or according to local standards and building regulations. The following requirements are bare minimums.

### Ventilation without perforated closure

The size of ventilation inlet and outlet should be between 10 and 20 mm ( $\geq 100$  cm<sup>2</sup>/m) and may need to be increased depending on local regulations and/or the vertical distance between them (cladding height).

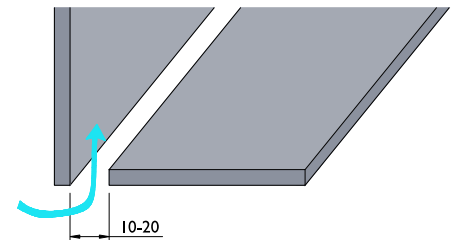

### Ventilation with perforated closure

If by local regulations the use of a perforated closure is required e. g. to vermin proof the cavity then the size of the inlet and outlet must be increased depending on the open area percentage of the used profile to achieve a bare minimum open area of more than 100 cm<sup>2</sup>/m. E.g., in case of a 35 % perforated closure the minimum open gap should be minimum 30 mm

The minimum open area may need to be increased depending on local regulations and/or the vertical distance between the ventilation inlet and outlet (cladding height)

The perforated angle should be less than 0.8 mm in thickness when placed between EQUITONE and the support frame

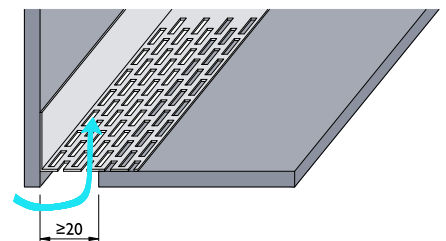



Important points to consider (Do's and Don'ts)

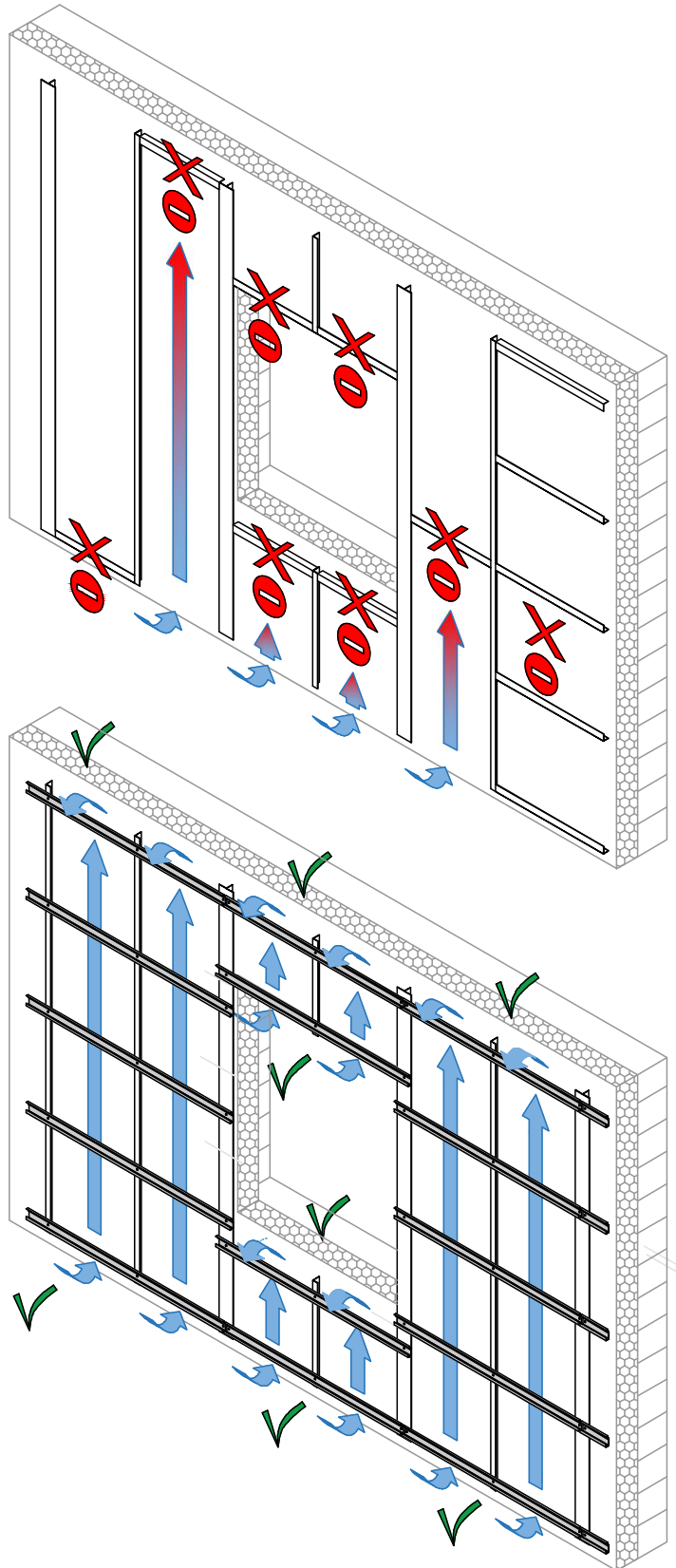

1. EQUITONE facade panel
2. Concealed anchor
3. Aluminium panel hanger
4. Aluminium horizontal system rail
5. Vertical aluminium support frame
6. Fixing of horizontal rail to support frame
7. Horizontal fixed point (1 per panel)
8. Height adjustment bolt (2 per panel)

Position of the different concealed anchors in the panel hanger

Keil

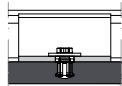

Fischer

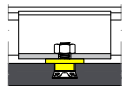

SFS

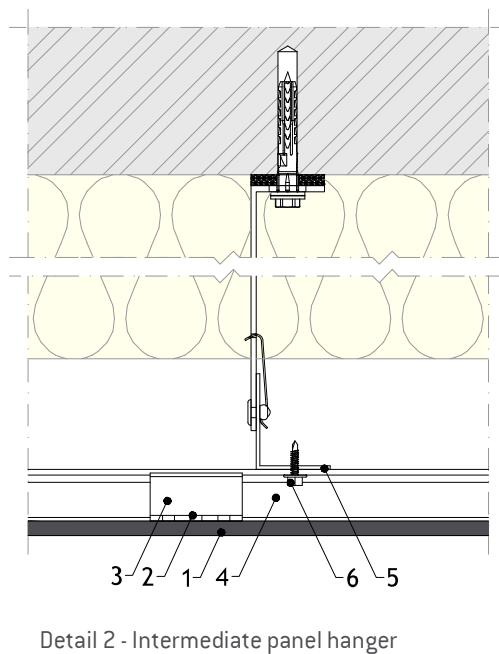
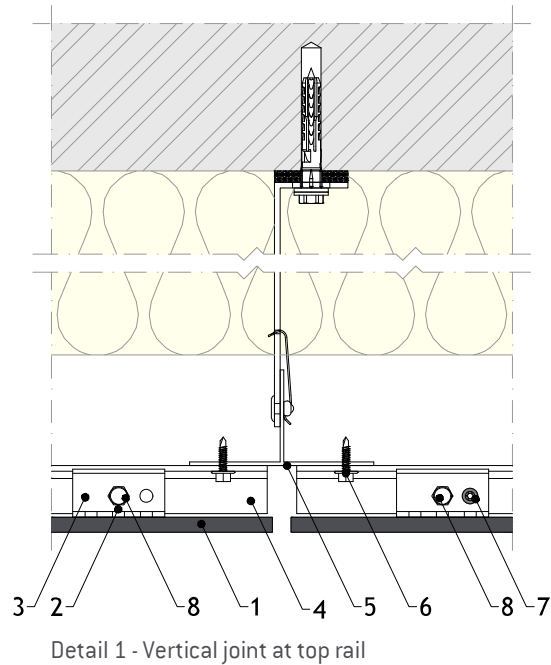
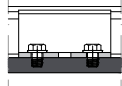

1. EQUITONE facade panel
2. Concealed anchor
3. Aluminium panel hanger
4. Aluminium horizontal system rail
5. Vertical aluminium support frame
6. Fixing of horizontal rail to support frame

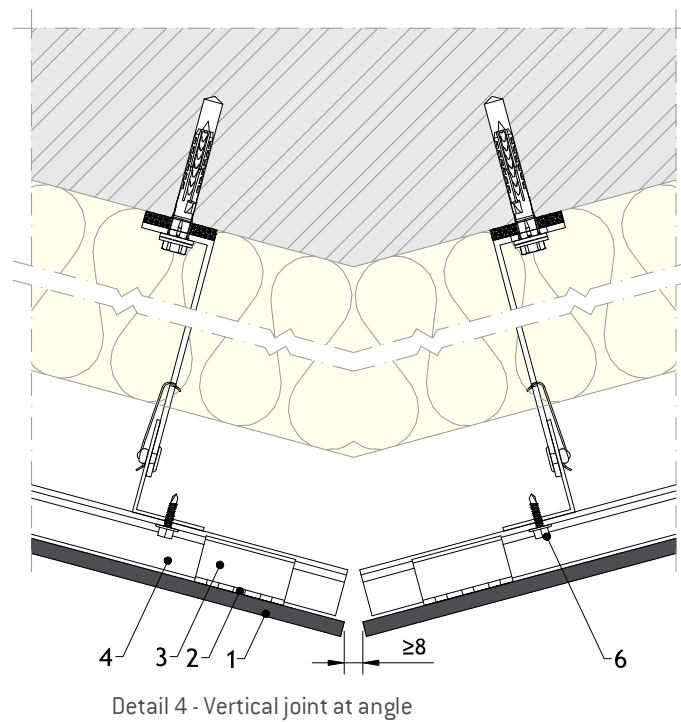
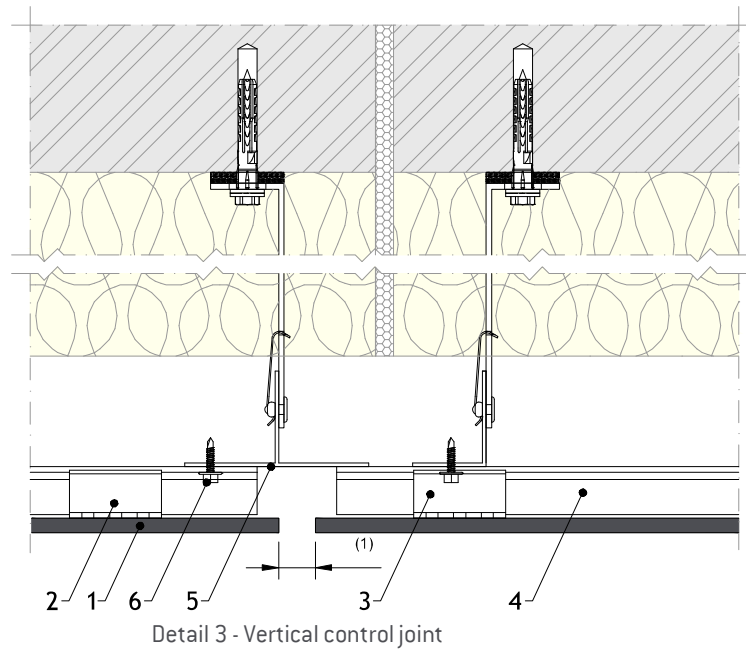

Notes:

- 1) The width of the facade control joint should be equal or greater than the building control joint.

1. EQUITONE facade panel
2. Concealed anchor
3. Aluminium panel hanger
4. Aluminium horizontal system rail
5. Vertical aluminium support frame
6. Fixing of horizontal rail to support frame
7. Height adjustment bolt (2 per panel)
8. Fixed point of horizontal system rail (1 per panel)
9. Gliding point of horizontal system rail
10. Fixed point bracket
11. Gliding point bracket

 Free air flow

Concealed anchor options - see page 5

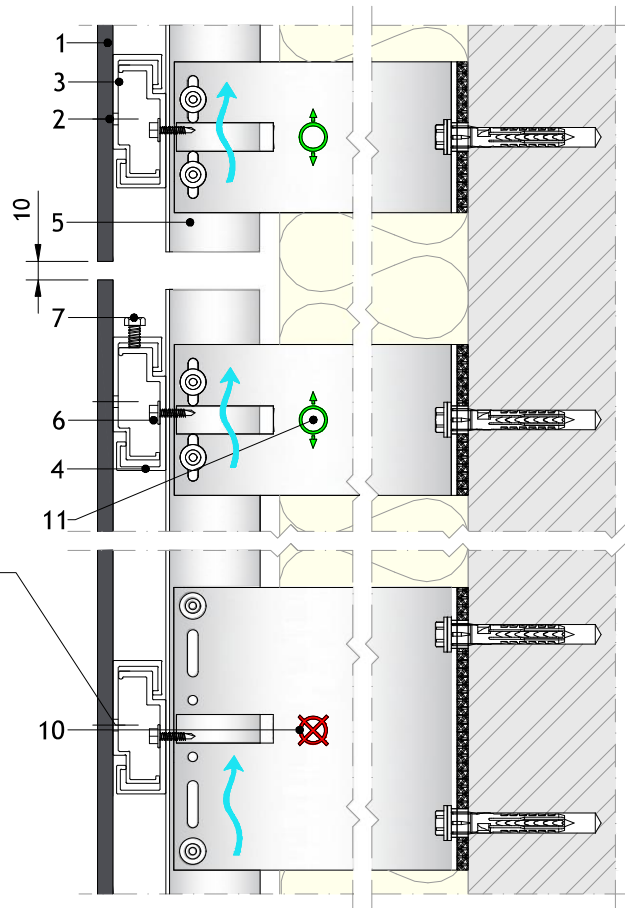
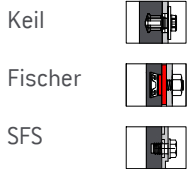

Detail 5 - Fixed and gliding points of support frame

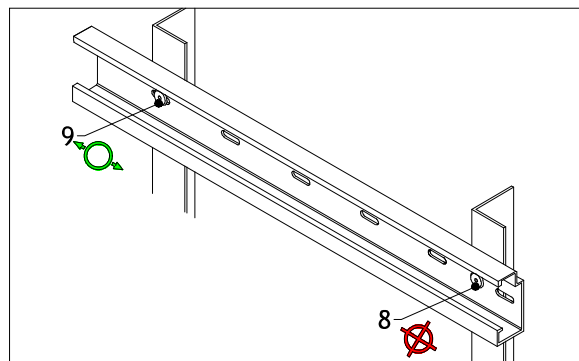

Isometric view of the horizontal system rail fixings

[Go to Content](#)

1. EQUITONE facade panel
2. Concealed anchor
3. Aluminium panel hanger
4. Aluminium horizontal system rail
5. Vertical aluminium support frame
6. Fixing of horizontal rail to support frame
7. Height adjustment bolt (2 per panel)
8. Fixed point screw (1 per panel)

↑ Free air flow

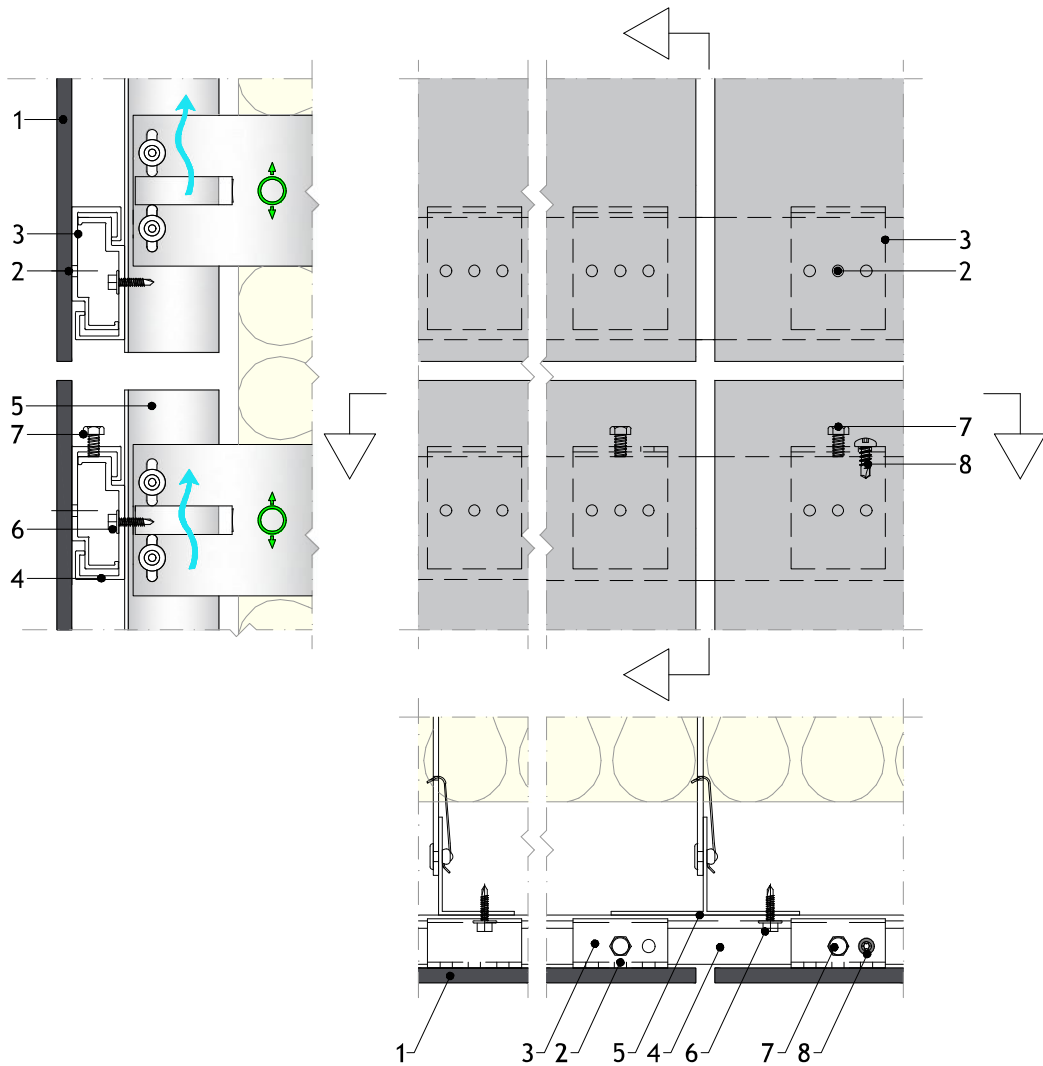

Detail 6 - Open horizontal joint junction with vertical joint

1. EQUITONE facade panel
2. Concealed anchor
3. Aluminium panel hanger
4. Aluminium horizontal system rail
5. Vertical aluminium support frame
6. Fixing of horizontal rail to support frame
7. Perforated closure
8. Skirting<sup>(2)</sup> in EQUITONE [tectiva], EQUITONE [pictura], EQUITONE [textura]
9. Hard insulation suitable for use below ground level

Free air flow

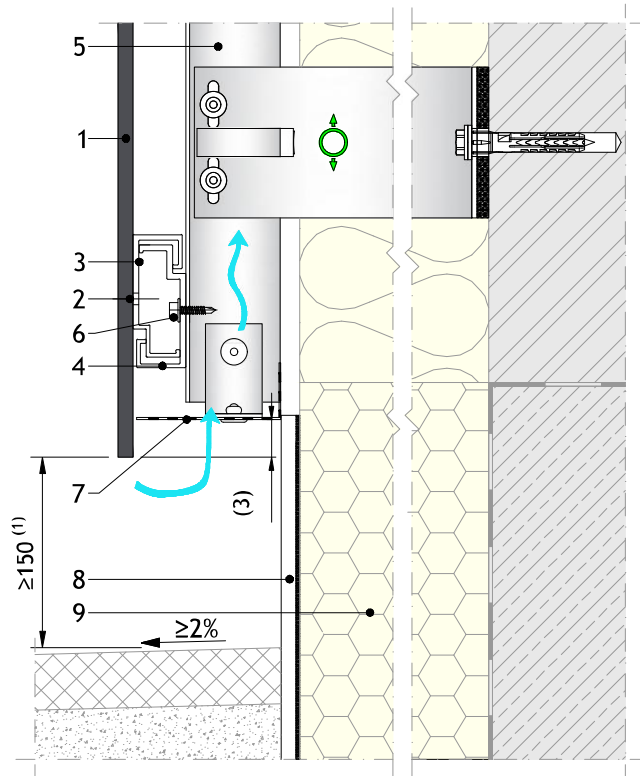
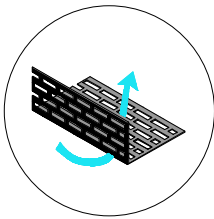

Detail 7 - Base detail – Ground floor

Detail 8 - Base detail – Covered area (not exposed to precipitation)

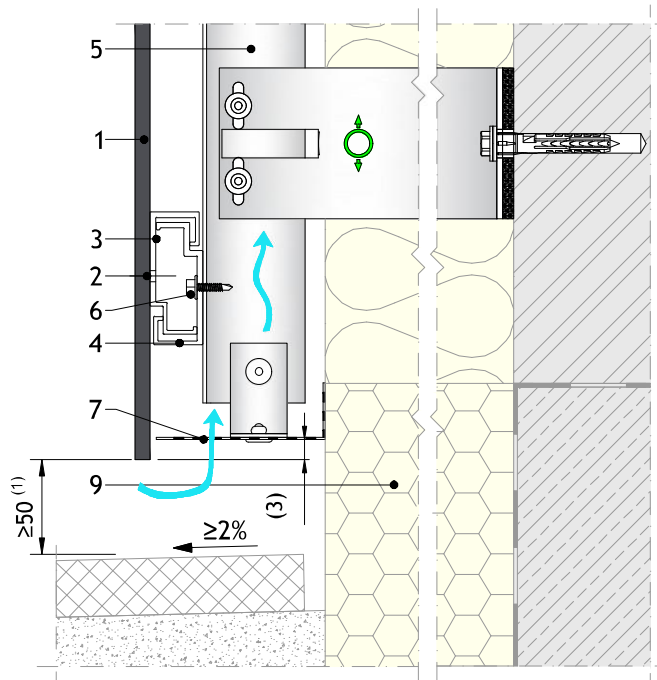

Notes:

- 1) The distance to ground level is recommended at minimum 150 mm. A smaller ground clearance is possible, but it may increase the risk of water marks and panel staining caused by splash back.
- 2) The skirting board could be concrete, natural stone, render, metal flashing or EQUITONE.
- 3) The facade panel should preferably overhang more than 10 mm below the ventilation profile to create a drip edge.

[Go to Content](#)

1. EQUITONE facade panel
2. Concealed anchor
3. Aluminium panel hanger
4. Aluminium horizontal system rail
5. Vertical aluminium support frame
6. Fixing of horizontal rail to support frame
7. Perforated closure
8. Balcony floor

Free air flow

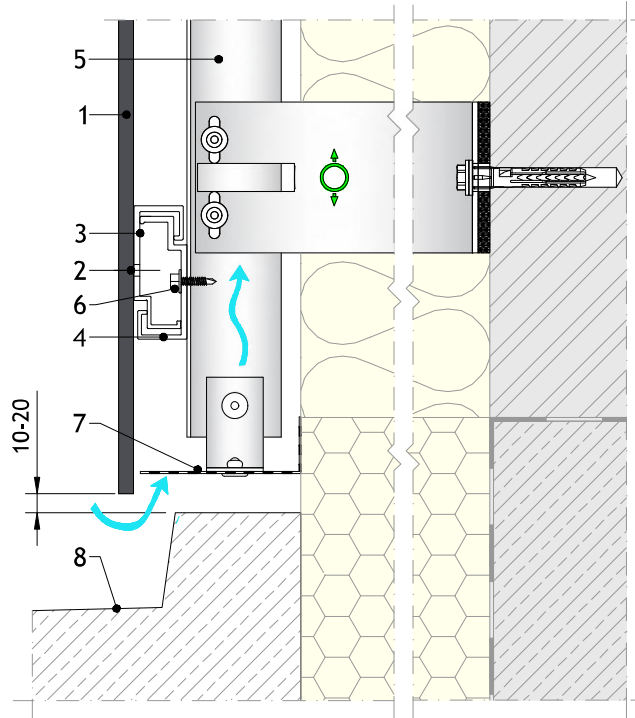
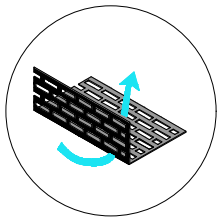

Detail 9 - Base detail – Balcony

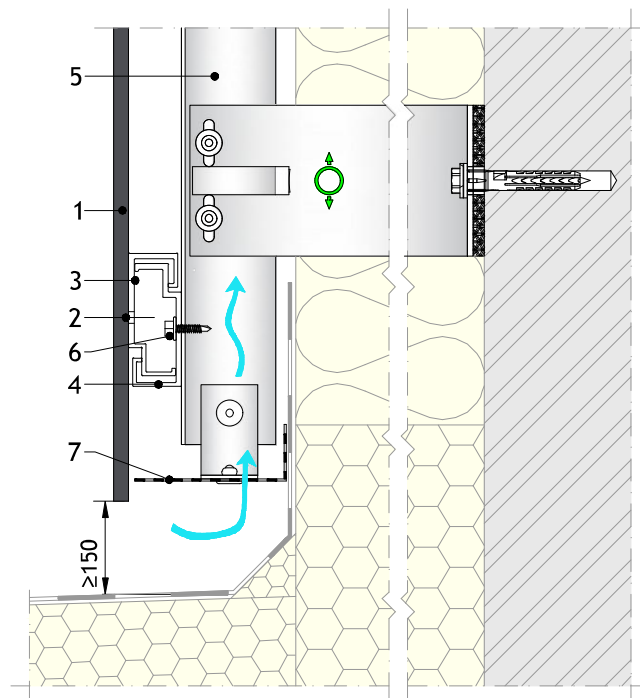

Detail 10 - Base detail – Flat roof abutment / Parapet

1. EQUITONE facade panel
2. Concealed anchor
3. Aluminium panel hanger
4. Aluminium horizontal system rail
5. Vertical aluminium support frame
6. Fixing of horizontal rail to support frame
7. Perforated closure

 Free air flow

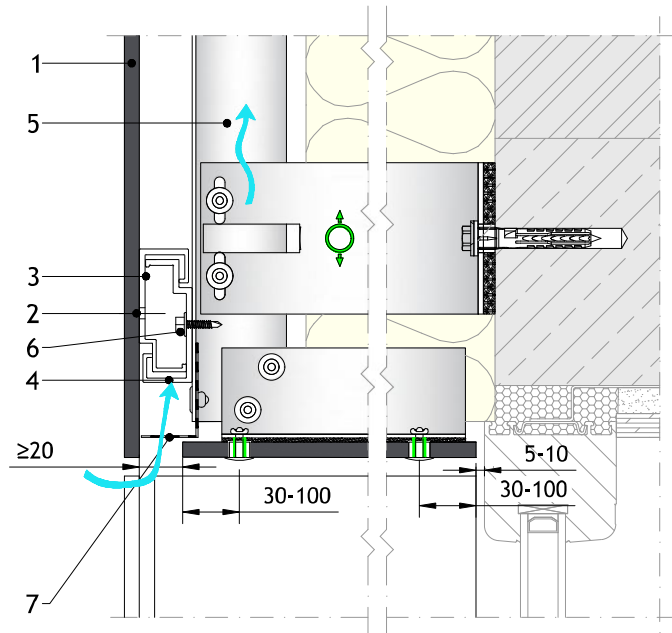
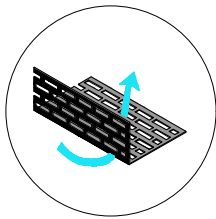

Detail 11 - Window head – Option 1

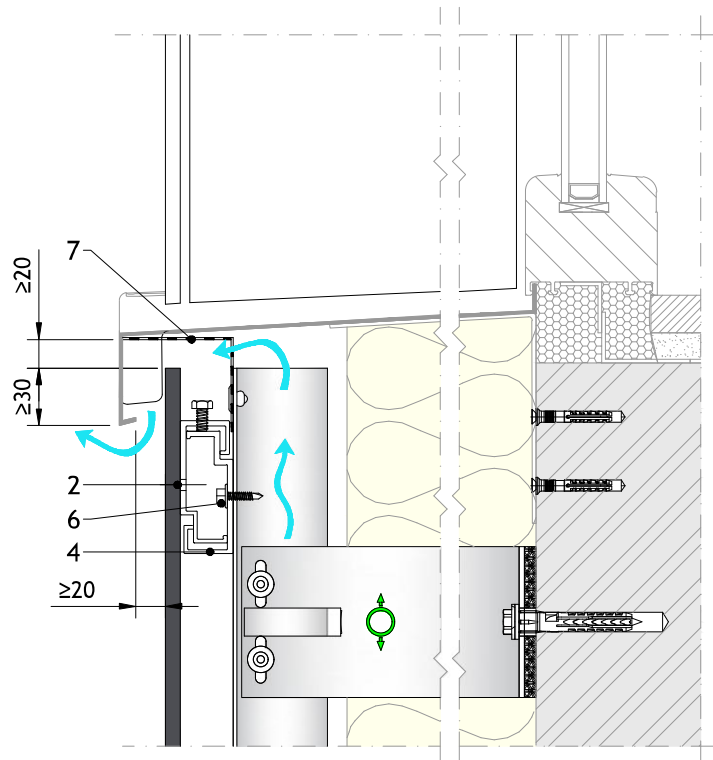

Detail 12 - Window sill – Option 1

Notes:

- 1) When no perforated closure is used at the ventilation inlet, the inlet opening should be between 10 and 20 mm.
- 2) The ventilation inlet should be increased depending on building height and local legislation. When the inlet is wider than 20 mm, a perforated closure is recommended. Total perforation should have a minimum of 100 cm<sup>2</sup>/m.



1. EQUITONE facade panel
2. Concealed anchor
3. Aluminium panel hanger
4. Aluminium horizontal system rail
5. Vertical aluminium support frame
6. Fixing of horizontal rail to support frame

Free air flow

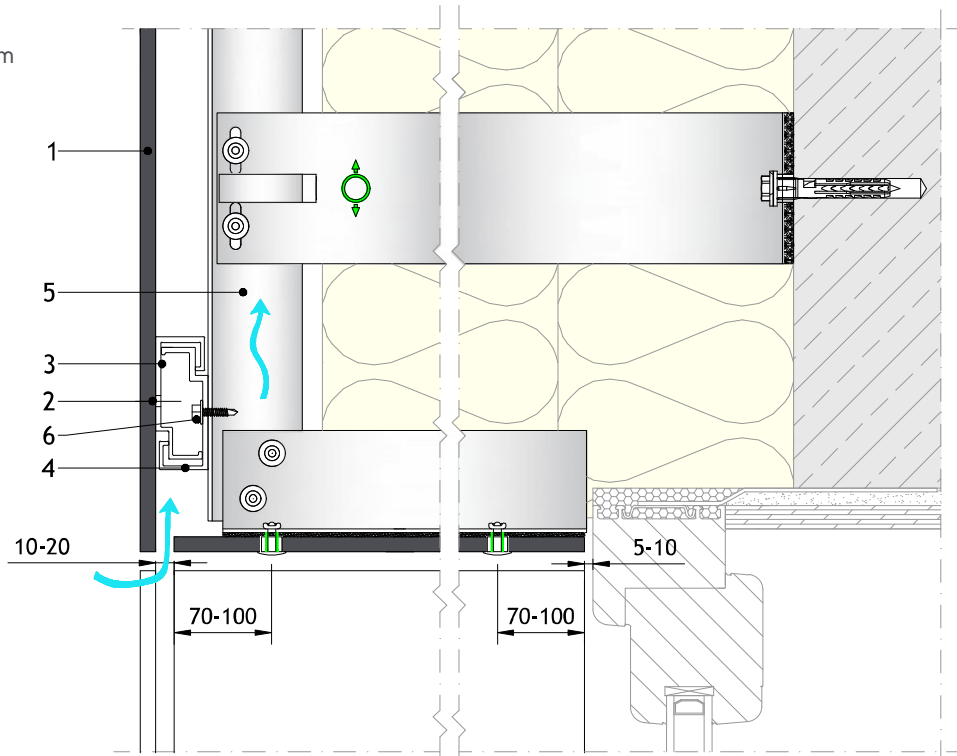
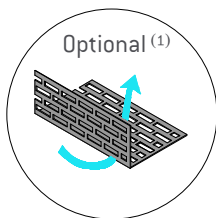

Detail 13 - Window head – Option 2

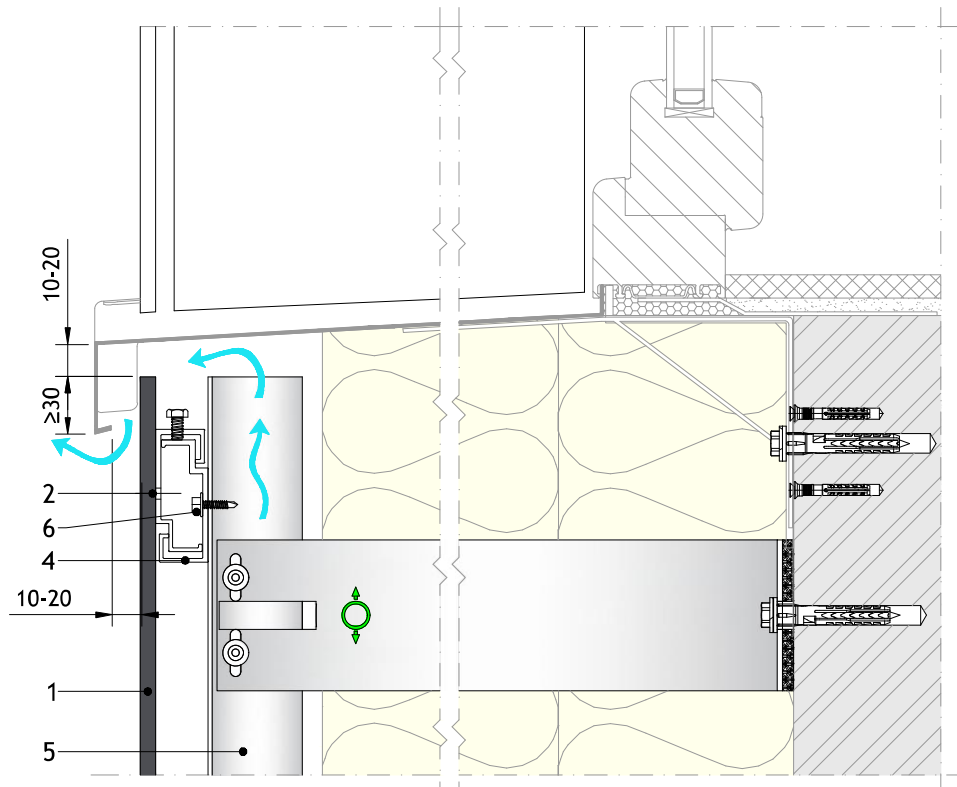

Detail 14 - Window sill – Option 2

Notes:

- 1) The ventilation inlet should be increased depending on building height and local legislation. When the inlet is wider than 20 mm, a perforated closure is recommended. Total perforation should have a minimum of 100 cm<sup>2</sup>/m.

1. EQUITONE facade panel
2. Concealed anchor
3. Aluminium panel hanger
4. Aluminium horizontal system rail
5. Vertical aluminium support frame
6. Fixing of horizontal rail to support frame
7. Aluminium flashing

Free air flow

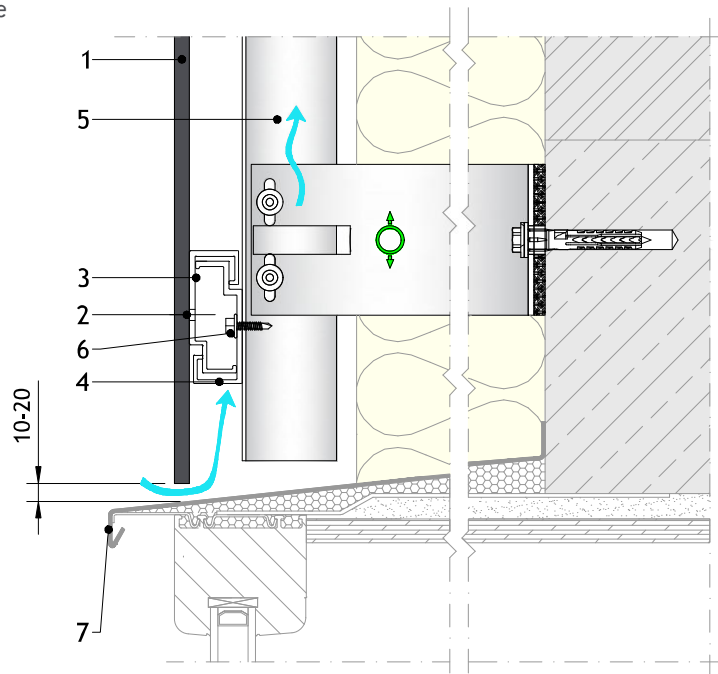
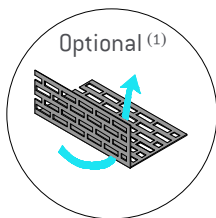

Detail 15 - Window head – Flush window

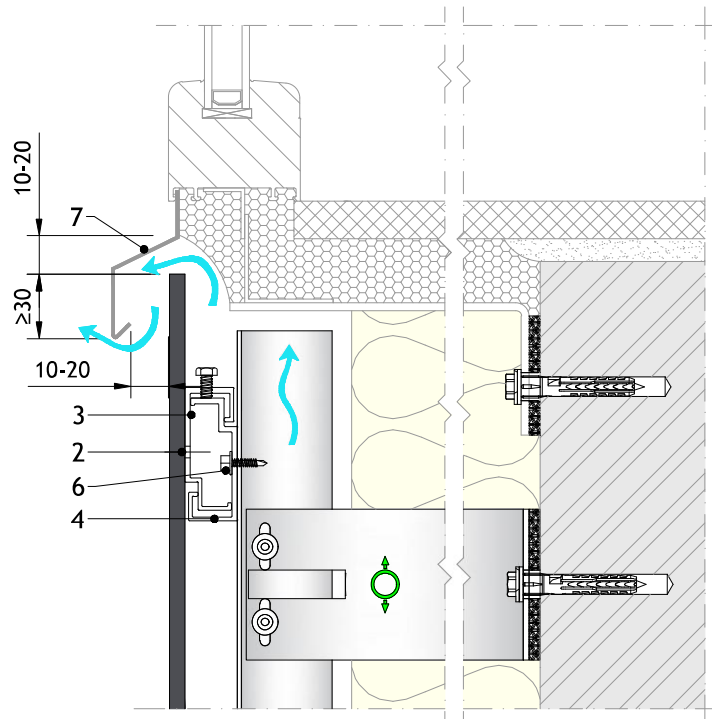

Detail 16 - Window sill – Flush window

Notes:

- 1) The ventilation inlet should be increased depending on building height and local legislation. When the inlet is wider than 20 mm, a perforated closure is recommended. Total perforation should have a minimum of 100 cm<sup>2</sup>/m.

1. EQUITONE facade panel
2. Concealed anchor
3. Aluminium panel hanger
4. Aluminium horizontal system rail
5. Vertical aluminium support frame
6. Fixing of horizontal rail to support frame
7. Perforated closure

 Free air flow

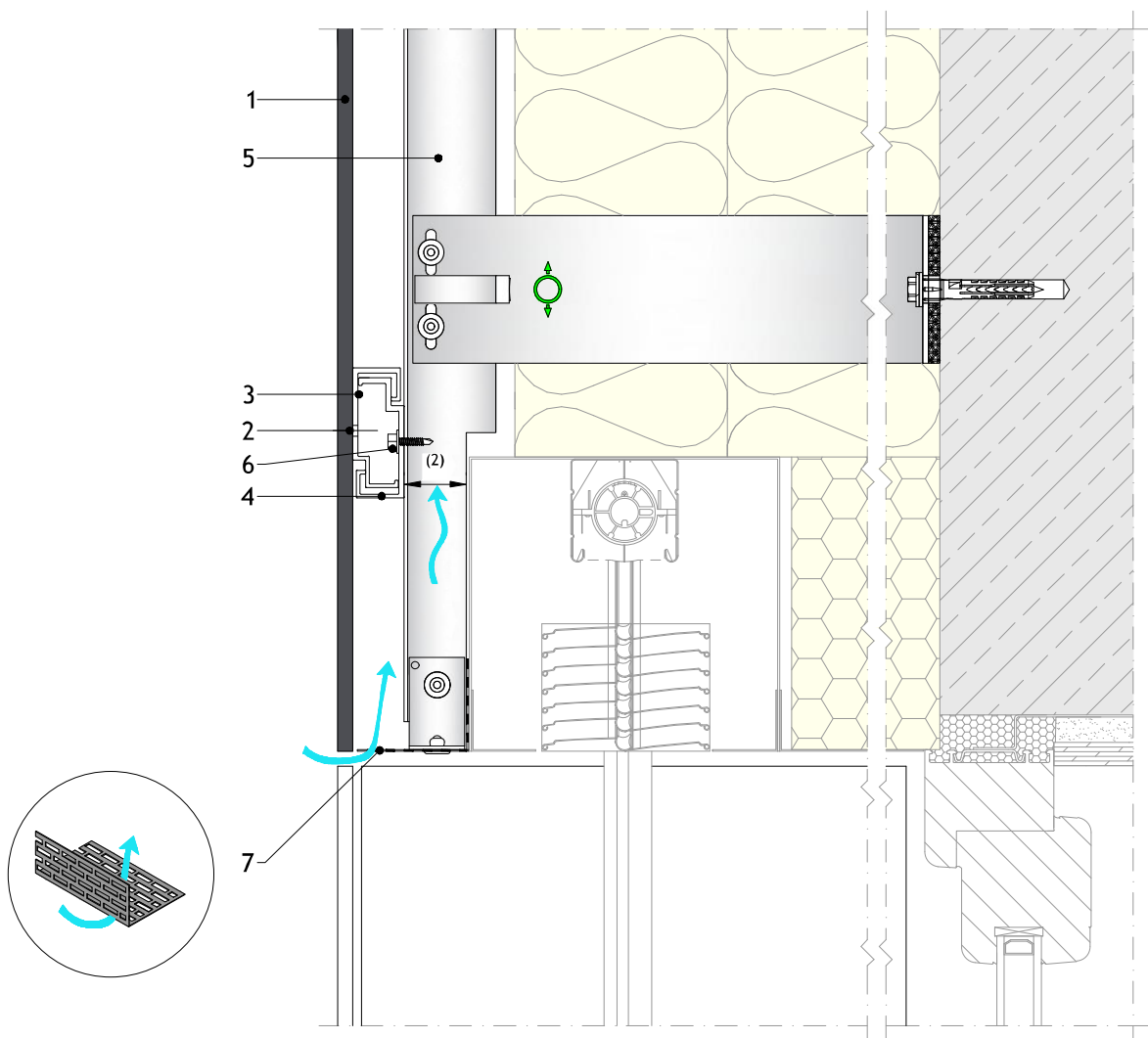

Detail 17 - Window head – With sunshade

Notes:

- 1) The ventilation inlet should be increased depending on building height and local legislation. When the inlet is wider than 20 mm, a perforated closure is recommended. Total perforation should have a minimum of 100 cm<sup>2</sup>/m.
- 2) The reduced section of the support profiles must be taken into account during static calculations.

1. EQUITONE facade panel
2. Concealed anchor
3. Aluminium panel hanger
4. Aluminium horizontal system rail
5. Vertical aluminium support frame
6. Fixing of horizontal rail to support frame
7. Perforated closure

 Free air flow

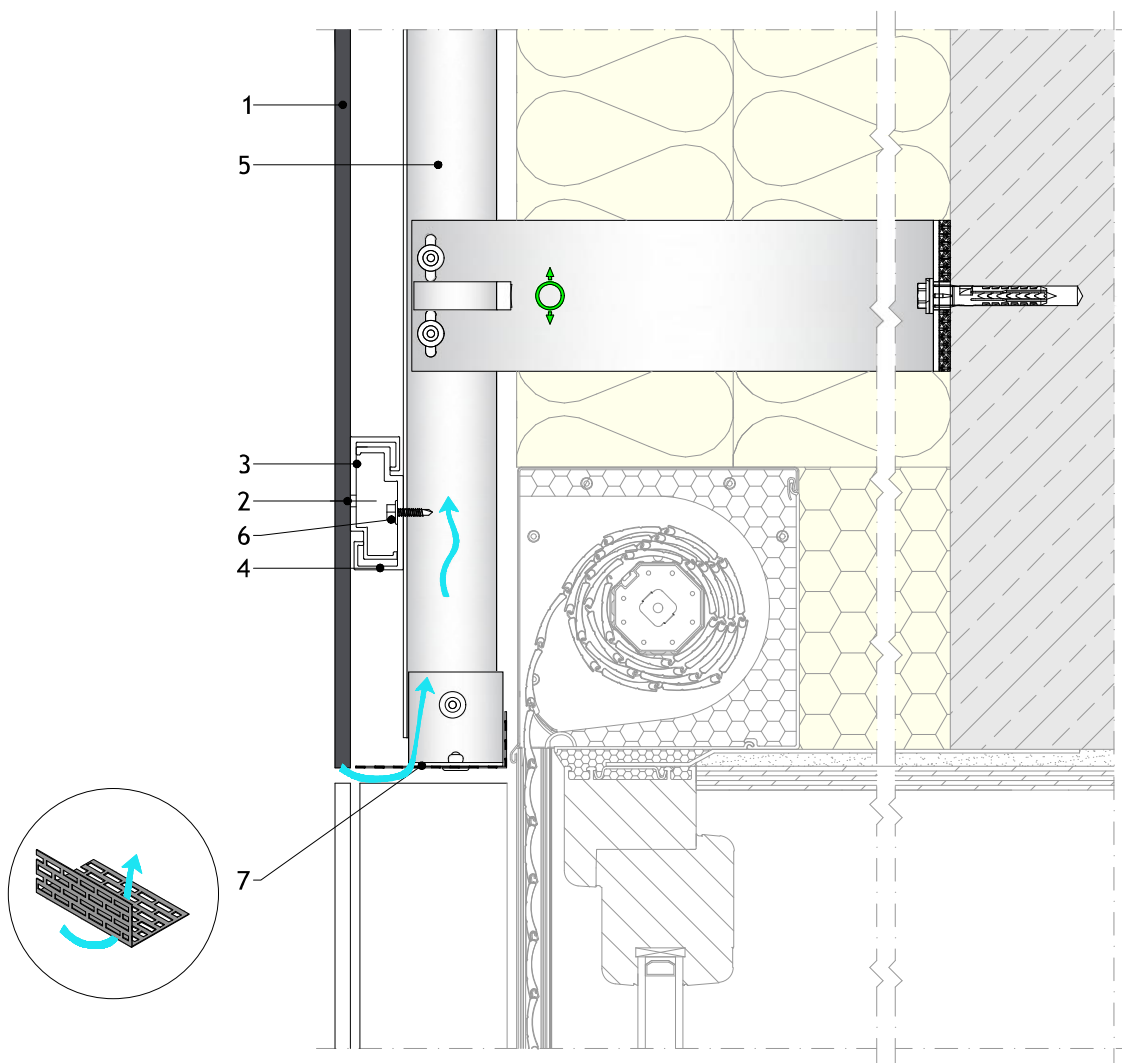

Detail 18 - Window head – With shutter

Note:

The ventilation inlet should be increased depending on building height and local legislation. When the inlet is wider than 20 mm, a perforated closure is recommended. Total perforation should have a minimum of 100 cm<sup>2</sup>/m.

[Go to Content](#)

1. EQUITONE facade panel
2. Concealed anchor
3. Aluminium panel hanger
4. Aluminium horizontal system rail
5. Vertical aluminium support frame
6. Fixing of horizontal rail to support frame

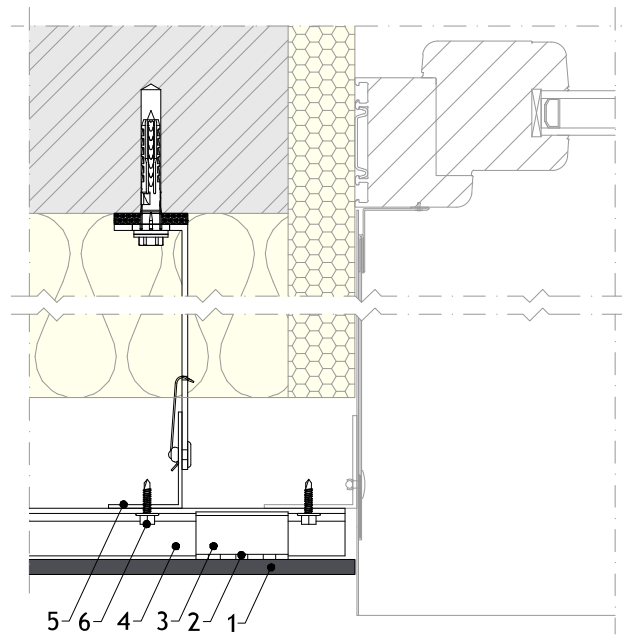

Detail 19 - Window jamb – Metal flashing

[Go to Content](#)

1. EQUITONE facade panel
2. Concealed anchor
3. Aluminium panel hanger
4. Aluminium horizontal system rail
5. Vertical aluminium support frame
6. Fixing of horizontal rail to support frame

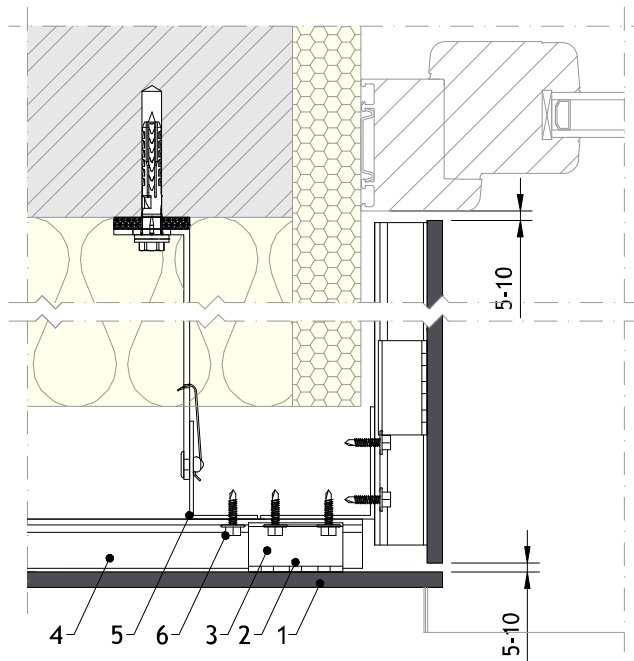

Detail 20 - Window jamb

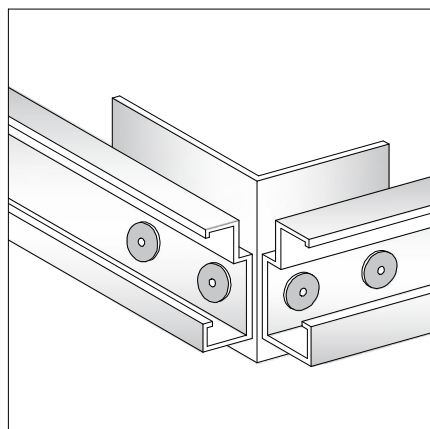

Isometric view of the corner connection of the horizontal system rails

1. EQUITONE facade panel
2. Concealed anchor
3. Aluminium panel hanger
4. Aluminium horizontal system rail
5. Vertical aluminium support frame
6. Fixing of horizontal rail to support frame

 Free air flow

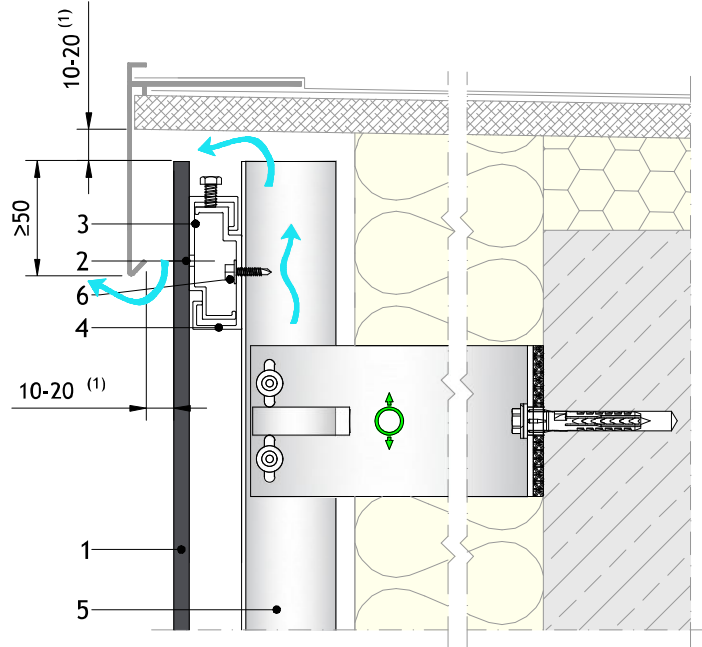

Detail 21 - Capping

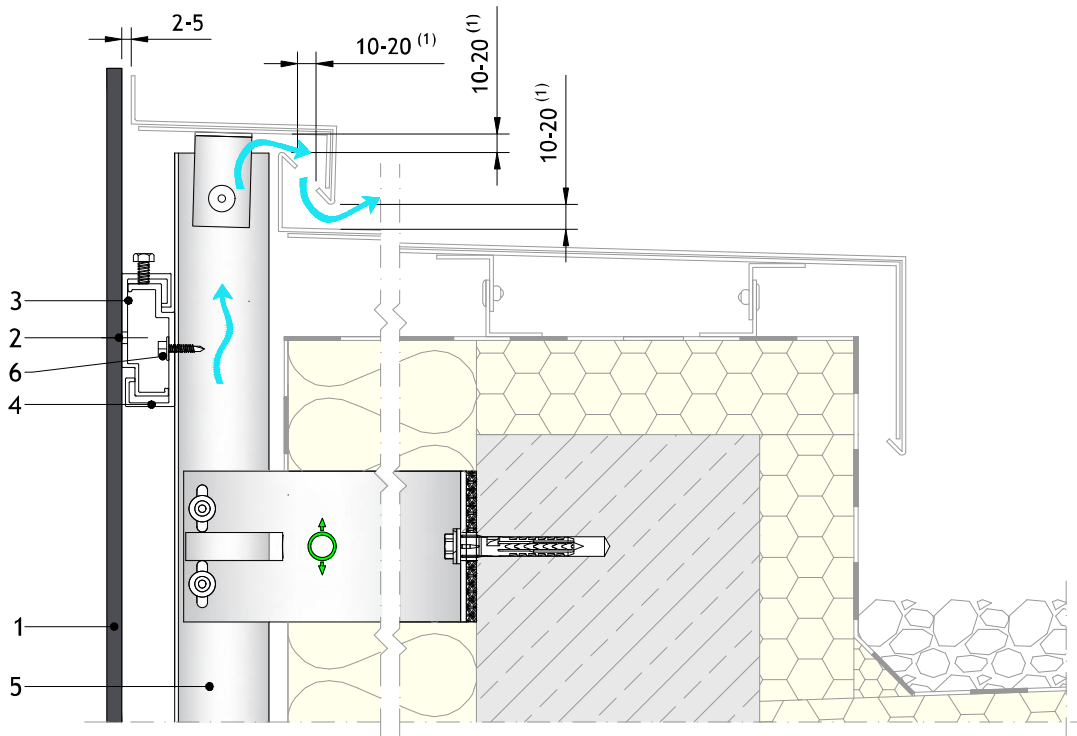

Detail 22 - Capping - Hidden ventilation

Notes:

- 1) When perforated closures are used underneath the capping the ventilation outlet opening between panel and capping should be a minimum of 30 mm.
- 2) The ventilation inlet should be increased depending on building height and local legislation. When the inlet is wider than 20 mm, a perforated closure is recommended. Total perforation should have a minimum of 100 cm<sup>2</sup>/m.

[Go to Content](#)

1. EQUITONE facade panel
2. Concealed anchor
3. Aluminium panel hanger
4. Aluminium horizontal system rail
5. Vertical aluminium support frame
6. Fixing of horizontal rail to support frame

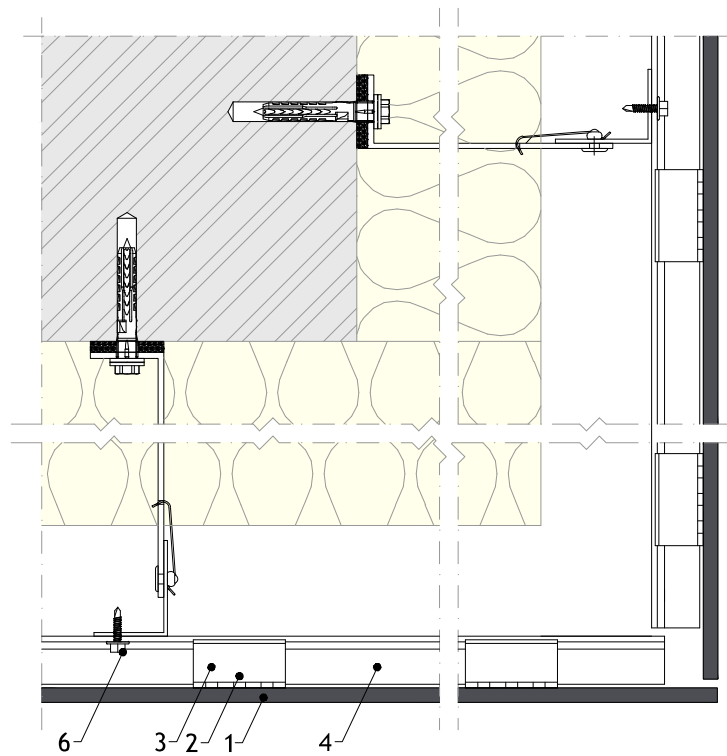

Detail 23 - External corner



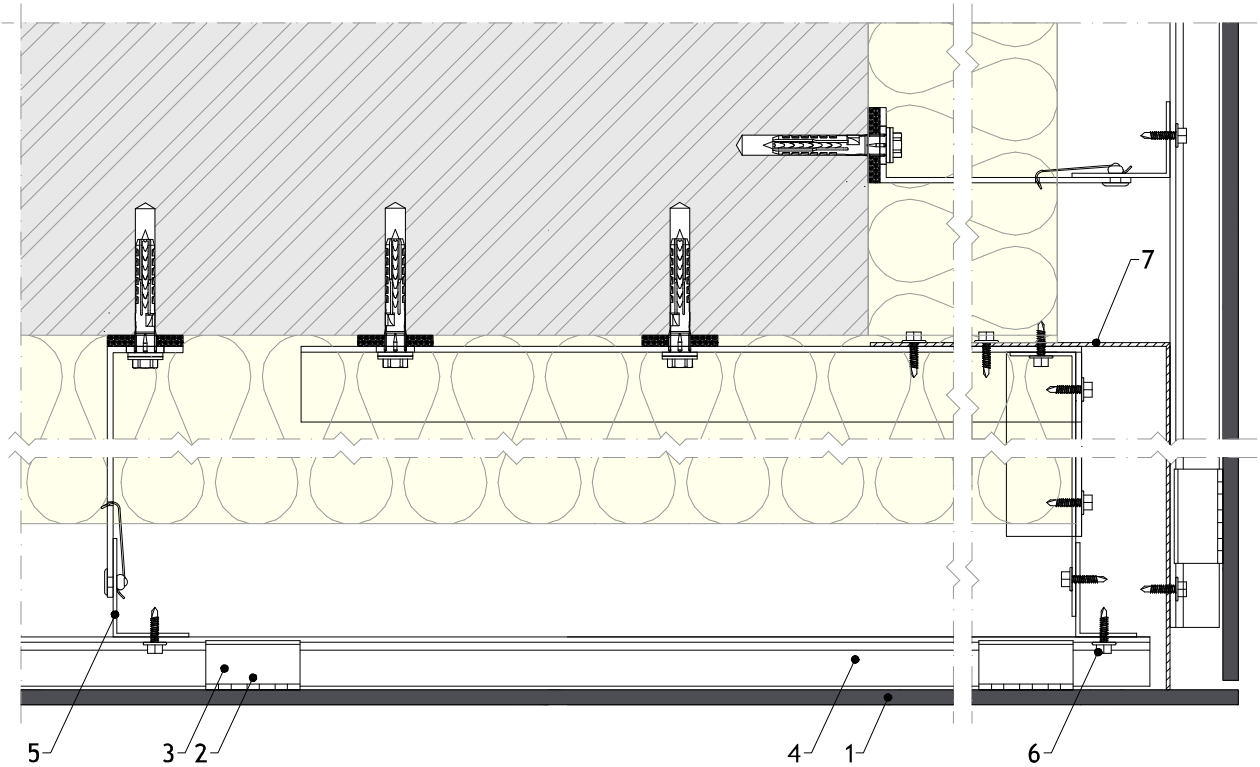

Detail 24 - External corner with wind barrier

1. EQUITONE facade panel
2. Concealed anchor
3. Aluminium panel hanger
4. Aluminium horizontal system rail
5. Vertical aluminium support frame
6. Fixing of horizontal rail to support frame
7. Wind barrier (metal)

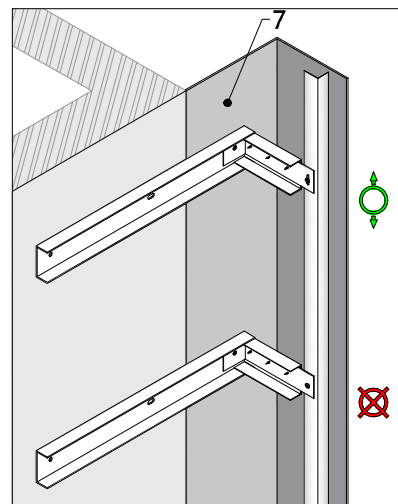

Isometric view of the support frame

Notes:

The installation of wind barrier is subject to local standards and building regulation.

[Go to Content](#)

1. EQUITONE facade panel
2. Concealed anchor
3. Aluminium panel hanger
4. Aluminium horizontal system rail
5. Vertical aluminium support frame
6. Fixing of horizontal rail to support frame

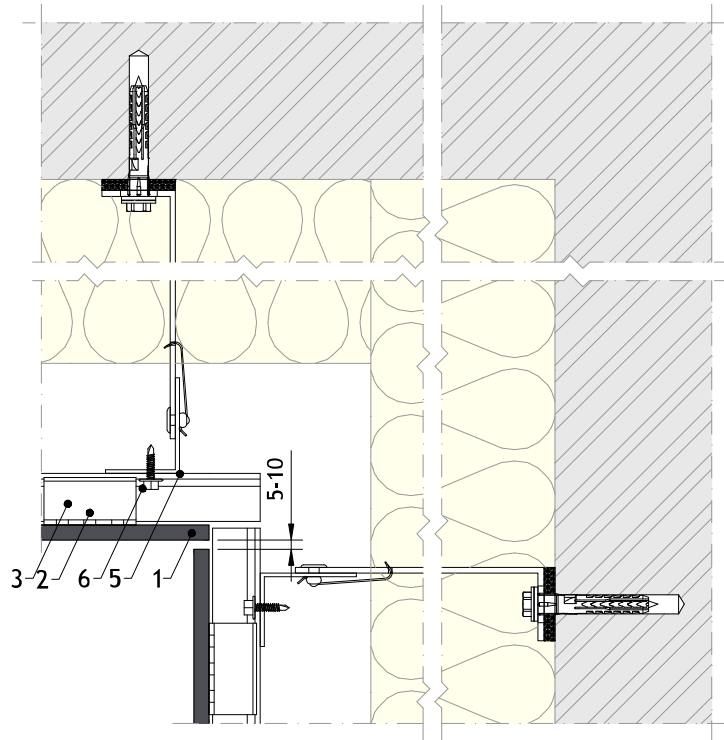

Detail 25 - Internal corner

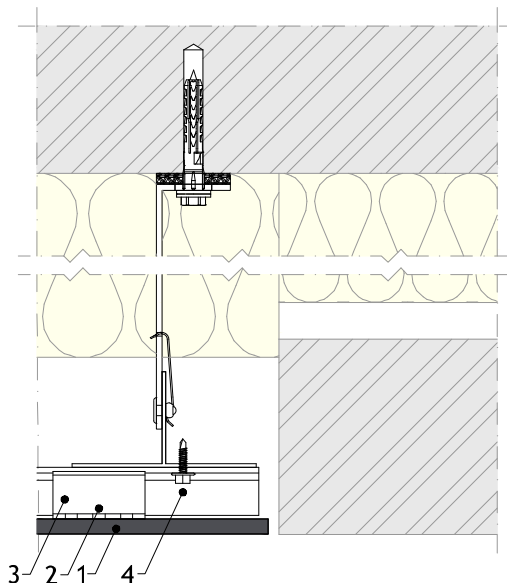

Detail 26 - Abutment

1. EQUITONE facade panel
2. Concealed anchor
3. Aluminium panel hanger
4. Aluminium horizontal system rail
5. Vertical aluminium support frame
6. Fixing of horizontal rail to support frame
7. Adjacent façade system
8. Aluminium flashing

 Free air flow

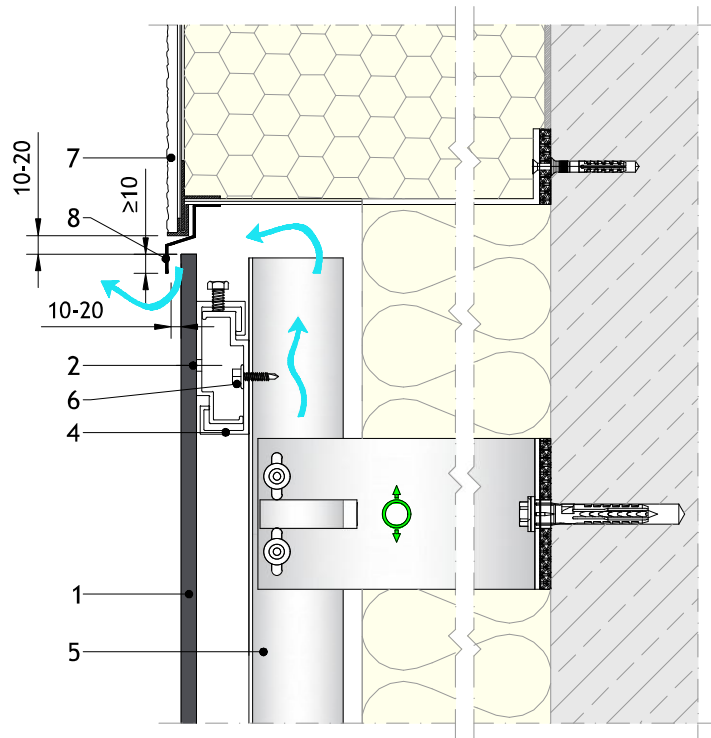

Detail 27 - Junction with other facade material – Head detail

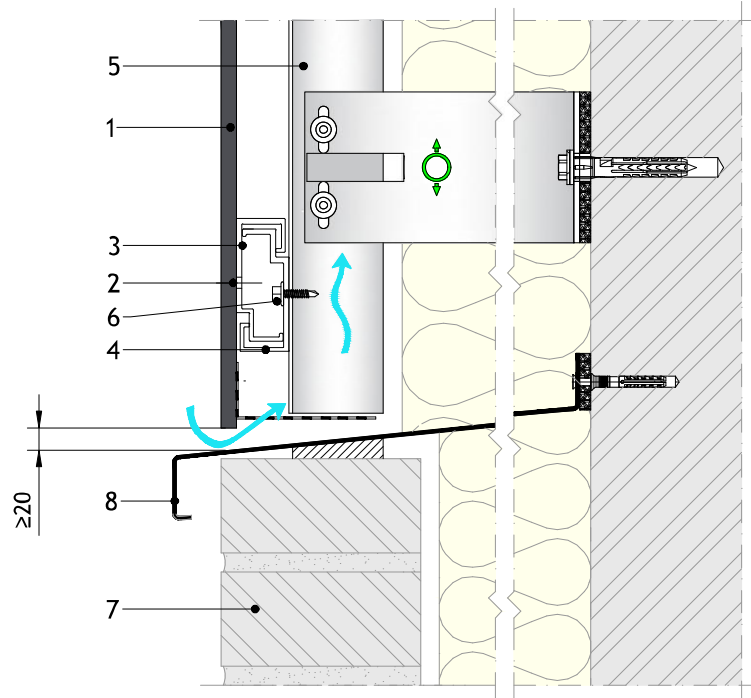

Detail 28 - Junction with other facade material – Base

Note:

The ventilation inlet should be increased depending on building height and local legislation. When the inlet is wider than 20 mm, a perforated closure is recommended. Total perforation should have a minimum of 100 cm<sup>2</sup>/m.

[Go to Content](#)

1. EQUITONE facade panel
2. Concealed anchor
3. Aluminium panel hanger
4. Aluminium horizontal system rail
5. Vertical aluminium support frame
6. Fixing of horizontal rail to support frame

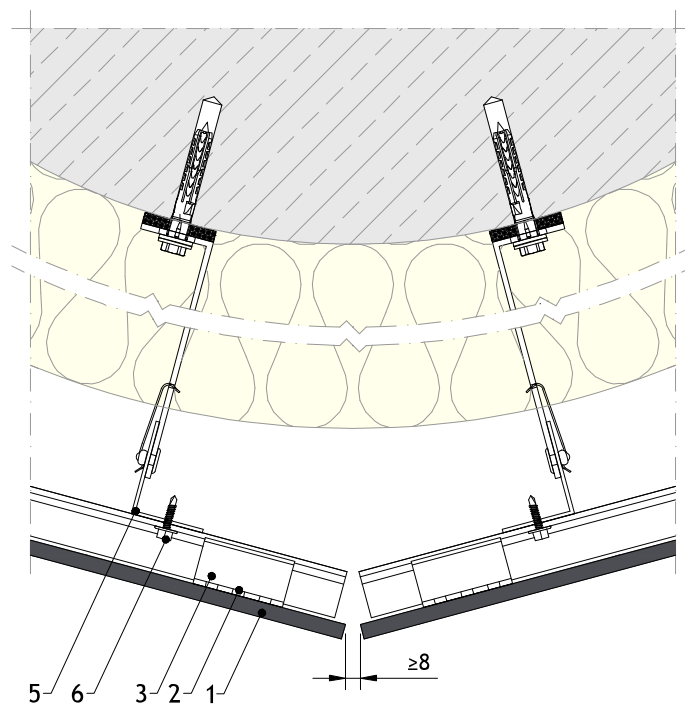

Detail 29 - Segmented façade

## Notes:

- 1) Curved walls should be executed as segmented facade.
- 2) Flashings to close the joints may not be thicker as 0.8 mm.

1. EQUITONE facade panel
2. Concealed anchor
3. Aluminium panel hanger
4. Aluminium horizontal system rail
5. Vertical aluminium support frame
6. Fixing of horizontal rail to support frame
7. Foam tape
8. UNI-Rivet
9. Perforated closure

 Free air flow

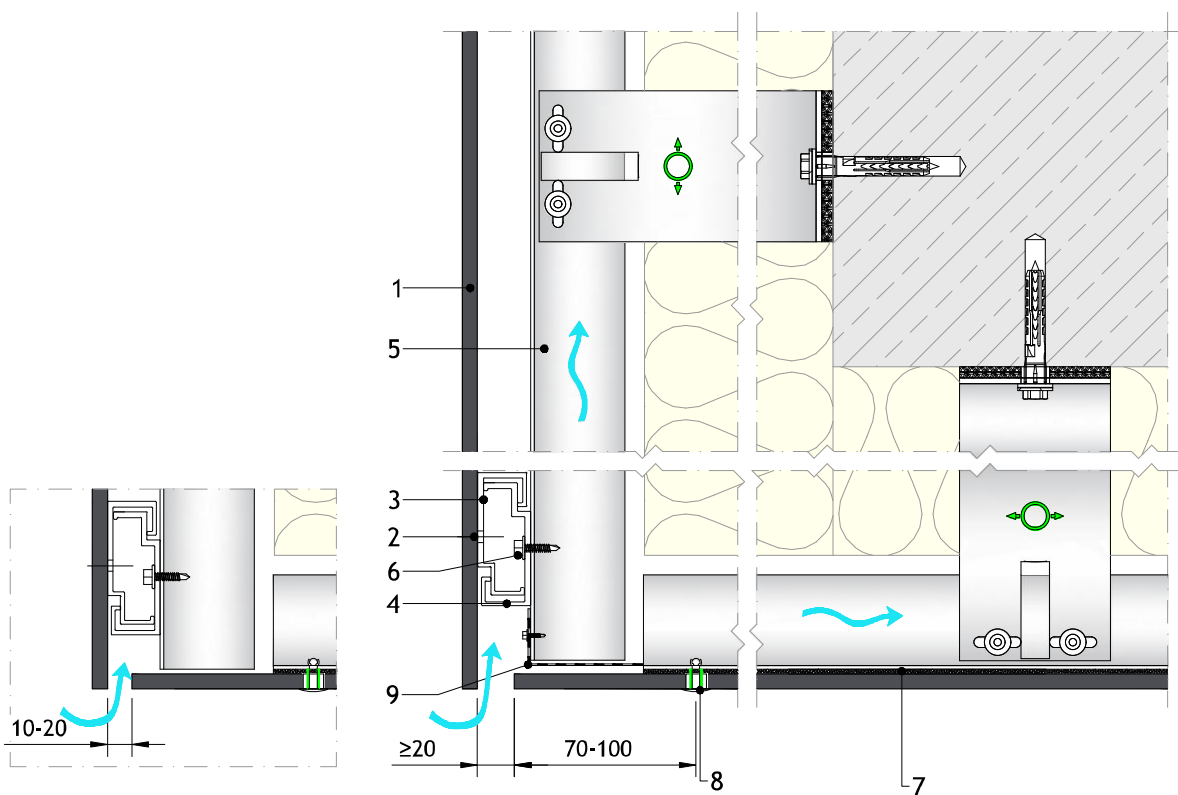

Detail 30 - Soffit/ceiling-wall junction

Notes:

- 1) The maximum centre-spacing between the UNI-rivets in a ceiling application is 400 mm.
- 2) When no perforated closure is used at the ventilation inlet, the inlet opening should be between 10 and 20 mm. Total perforation should have a minimum of 100 cm<sup>2</sup>/m.
- 3) The ventilation inlet should be increased depending on building height and local legislation. When the inlet is wider than 20 mm, a perforated closure is recommended.

[Go to Content](#)

1. EQUITONE facade panel
2. Concealed anchor
3. Aluminium panel hanger
4. Aluminium horizontal system rail
5. Vertical aluminium support frame
6. Fixing of horizontal rail to support frame
7. Foam tape
8. UNI-Rivet

 Free air flow

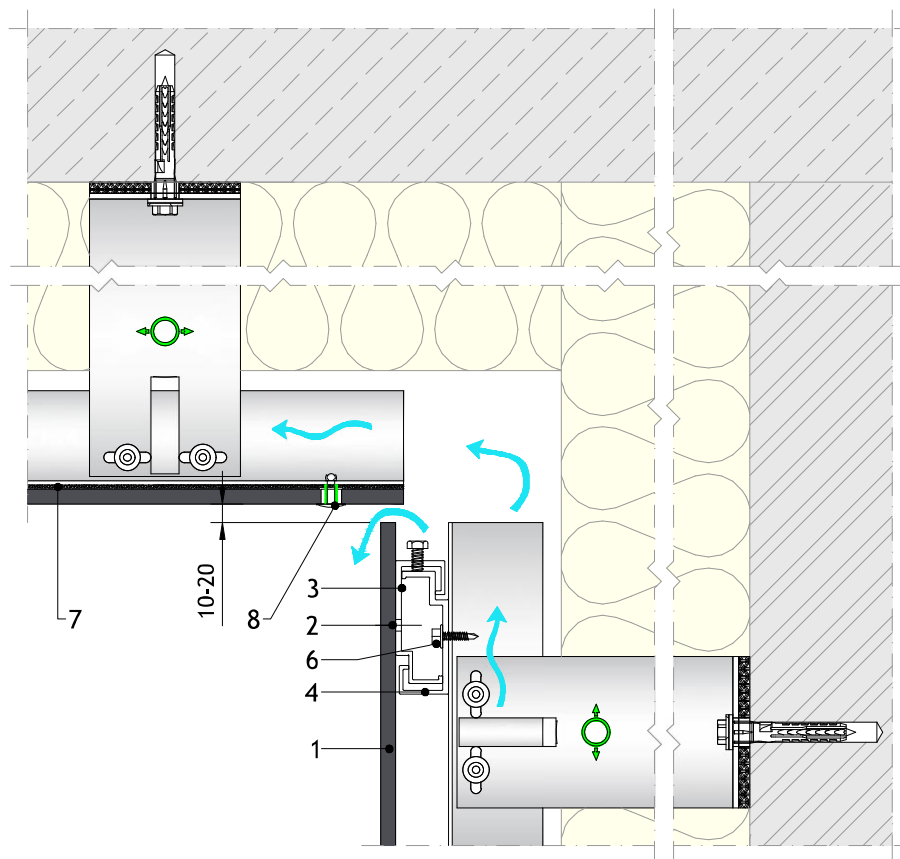

Detail 31 - Wall-soffit/ceiling junction

Notes:

- 1) The maximum centre-spacing between the UNI-rivets in a ceiling application is 400 mm.
- 2) When no perforated closure is used at the ventilation inlet, the inlet opening should be between 10 and 20 mm. Total perforation should have a minimum of 100 cm<sup>2</sup>/m.
- 3) The ventilation inlet should be increased depending on building height and local legislation. When the inlet is wider than 20 mm, a perforated closure is recommended.

[Go to Content](#)

1. EQUITONE facade panel
2. Concealed anchor
3. Aluminium panel hanger
4. Aluminium horizontal system rail
5. Vertical aluminium support frame
6. Fixing of horizontal rail to support frame
7. Foam tape
8. UNI-Rivet

 Free air flow

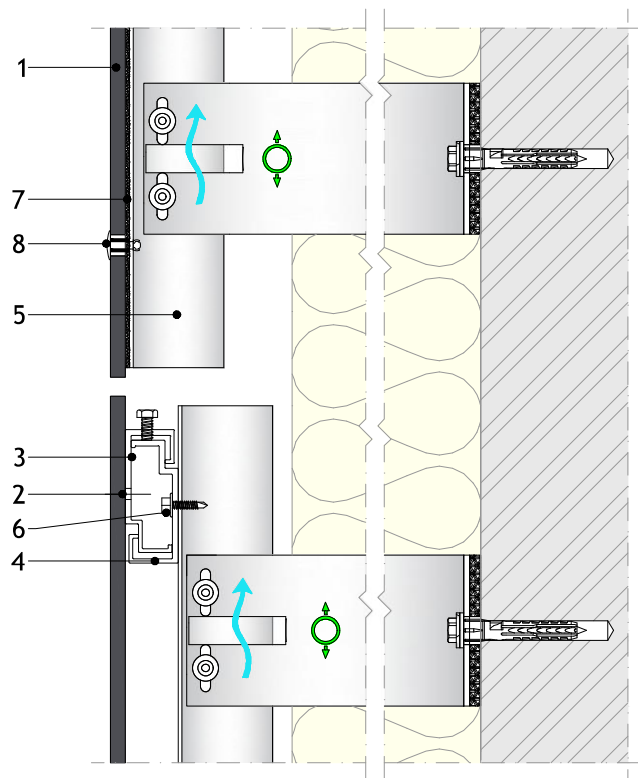

Detail 32 - Junction with panels with face fixings

Notes:

- 1) Check the construction details for face fixing for more information.
- 2) Depending on the specified concealed fixing system the minimum panel thickness could vary from 8 to 12 mm as applicable.
- 3) Special attention must be taken to the alignment of the panels with concealed fixing and the ones with face fixings.

[Go to Content](#)

---

#### Disclaimer

The information in this document is correct at time issuing. However, due to our committed program of continuous material and system development we reserve the right to amend or alter the information contained therein without prior notice. Please visit [www.equitone.com](http://www.equitone.com) to ensure you have the most current version. All figures contained in this document are illustrations and should not be used as construction drawings. This information is supplied in good faith and no liability can be accepted for any loss or damage resulting from its use. This document is protected by international copyright laws. Reproduction and distribution in whole or in part without prior written permission is strictly prohibited. EQUITONE and logos are trademarks of Etex NV or an affiliate thereof. Any use without authorisation is strictly prohibited and may violate trademark laws.



[www.equitone.com](http://www.equitone.com)