



 **EQUITONE**

design & installation guide

EQUITONE with face fixings on metal support frame

Australia



Contents

Introduction	2		
General information	2		
About EQUITONE	2		
Disclaimer	2		
EQUITONE materials	3		
Materials	3		
Maximum panel sizes	4		
EQUITONE facade	5		
Ventilated façade	5		
General components	7		
Cladding components	7		
Recommended weather (resistive) barrier options	8		
Weather barrier components	9		
Accessories	10		
General accessories	10		
Material specific accessories	11		
Support frame	12		
General support frame options	12		
Panel storage	14		
General requirements	14		
Outside storage	14		
Other trades	14		
Panels on edge	15		
Stacking panels	15		
Pallets	15		
Panel moving	16		
Lifting	16		
Forklift	16		
Panel handling	17		
Handling	17		
Suction lifters	17		
Carrying Straps	17		
Gloves	17		
Panel preparation	18		
Tools & accessories	18		
Health & safety	18		
Panel cutting	19		
Panel drilling	21		
		Drilling EQUITONE [lines]	22
		Panel holes edge distance	23
		EQUITONE [natura] edge treatment	24
		Panel installation	25
		Tools and accessories	25
		Panel horizontal joints	26
		Panel vertical joints	27
		Typical joint width	28
		Staggered vertical joint	28
		UNI Rivet fixing principle	29
		Location of STOP points	29
		Centralising tool application	31
		Rivet fixing operation	32
		Panel fixing procedure	33
		Installation sequence	34
		Flashings thickness	36
		Coordination with other trades	36
		Typical construction details	36
		Engineering	37
		EQUITONE	37
		Support frame	38
		Support frame thermal movement	43
		Support frame length & joints	43
		Design considerations	44
		Application	44
		Weatherproofing	47
		Corrosion zones	48
		Cyclonic areas	49
		Fire safety	49
		Bushfire zones	49
		Fire rated walls	50
		External fixtures	51
		Maintenance & warranty	52
		Inspections	52
		Soiling process and metal cover flashings	52
		Cleaning	52
		Efflorescence	53
		Graffiti	53
		Panel removal or replacement	53
		Warranty	53
		Installation checklist	54
		Notes	56

Introduction



General information

This Design and Installation Guide serves only as a general guide providing basic design considerations and information in relation to the application and installation of EQUITONE façade systems for common external applications. This guide illustrates that the installation of EQUITONE fibre cement façade materials is straight forward, provided some simple rules are followed.

EQUITONE typical construction details are available as separate documents which must be read in conjunction with this Design and Installation Guide.

About EQUITONE

EQUITONE is the world's leading architectural fibre cement facade material. EQUITONE evokes the unique characteristics of fibre cement. Fibre cement is a mineral composite with outstanding physical and aesthetic properties. Our company, Etex, has led development and innovation of this versatile architectural building material for more than a century, under different brand names such as "Eternit". Today, EQUITONE is manufactured in state-of-the-art facilities in Germany and Belgium.

Disclaimer

The information in this guide is comprehensive but not exhaustive, and the reader will need to satisfy themselves that the contents of this guide are suitable for their intended application. It is the responsibility of the project consultants (designer, architect, and engineers) to ensure that the information and details provided in this document are appropriate for the project.

The information in this document is correct at the time of issuing. However, due to our committed program of continuous material and system development we reserve the right to amend or alter the information contained in this document without prior notice. Please contact your local EQUITONE sales organisation or visit www.equitone.com to ensure you have the most current version.

This document is supplied in good faith and no liability can be accepted for any loss or damage resulting from its use. Images and construction details contained in this document are not to a specific scale, and are indicative and for illustration purposes only.

This document is protected by International copyright laws. Reproduction and distribution in whole or in part without prior written permission is strictly prohibited. EQUITONE and logos are trademarks of Etex NV or an affiliate thereof. Any use without authorisation is strictly prohibited and may violate trademark laws.

EQUITONE materials

Materials



For detailed information about EQUITONE materials, manufacturing tolerances and their technical properties, refer to their Material Information Sheet available from local EQUITONE website.

EQUITONE finishes are available in a variety of colours. For all available colours refer to local EQUITONE website.



EQUITONE [tectiva] is a through-coloured, uncoated fibre cement facade material, characterised by a sanded surface and naturally occurring hues within the material. Every [tectiva] panel is unique, strongly expressing the raw texture of the core fibre cement material.

Thickness	Weight
8 mm	14.9 Kg/m ²

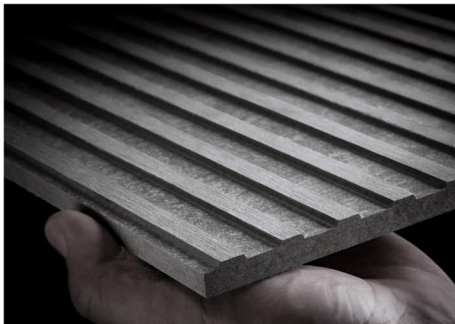

EQUITONE [lines] is a unique 3D shaped, through-coloured fibre cement facade material that plays with light and shadow. EQUITONE [lines] with longitudinal grooves displays a linear texture that highlights the raw inner texture of the core fibre cement material. Every moment of the day, the changing angle of the daylight gives the facade material a different aspect.

Thickness	Weight
10 mm	16.8 Kg/m ²

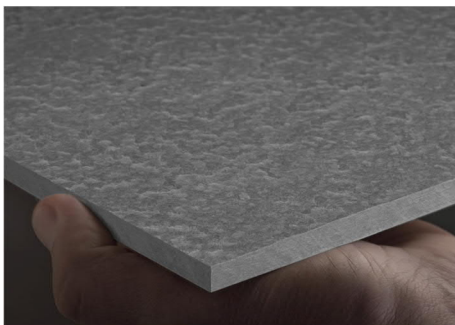

A through-coloured, uncoated fibre cement facade material, EQUITONE [lunara] embodies an honest and pure appearance. Featuring a unique texture, the surface of the panel is determined by a randomised surface treatment, which means no recurring pattern and no two panels being the same. Each facade is unique. Naturally occurring colour differences are also accentuated by the surface, as the extraordinary look and feel emphasises the originality of the fibre cement material.

Thickness	Weight
10 mm	18.6 kg/m ²

EQUITONE materials



EQUITONE [natura] is a through coloured fibre cement base board, with a semi-transparent coloured finish, subtly displaying the raw texture of the core fibre cement material. The rear face has a transparent sealing coating.

EQUITONE [natura] is also available in PRO, comprised of a UV-hardened, anti-graffiti and scratch resistant surface coating. EQUITONE [natura] PRO offers protection against common spray paints and scratches, making it an ideal choice for internal and high traffic areas.

Thickness	Weight
8 mm	15.4 Kg/m ²
12 mm	22.8 Kg/m ²

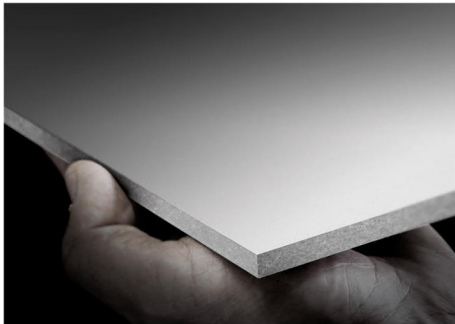

EQUITONE [pictura] is a fibre cement facade material with ultra matt architectural finish comprised of a UV-hardened, anti-graffiti and scratch resistant surface coating.

Thickness	Weight
8 mm	15.4 Kg/m ²
12 mm	22.8 Kg/m ²

Maximum panel sizes

EQUITONE [tectiva]
EQUITONE [lines]
EQUITONE [lunara]

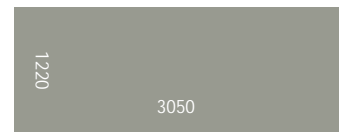

EQUITONE [natura]
EQUITONE [natura] PRO
EQUITONE [pictura]

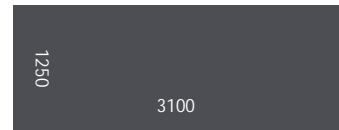
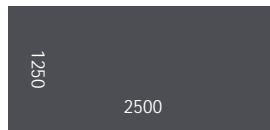

EQUITONE facade

Ventilated façade

EQUITONE has been designed for a ventilated façade system. A ventilated façade is a kind of two stage construction, an inner structure with a protective outer skin, and the cladding panel or rainscreen. A ventilated façade consists of an insulated and weathertight structure, a ventilated cavity formed with a cladding support frame and the cladding panel.

The concept for the 4 D's of Weathertightness is another simple way of explaining a Ventilated Facade. This principle is gaining popularity as it draws particular attention not only to the weathertightness of a building envelop with proper application of a suitable weather barrier, but also to the application of appropriate flashings and the like for the deflection and directing of any moisture, entering the cladding cavity, out and away from the façade rather than over-relying on any exposed sealants and sealing of cladding skin.

Deflection: Proper detailing of façade and flashings for deflection, with the aim of keeping water out

Drainage: Allowance for clear paths for the water to drain outside, should water get in

Drying: Adequate provision for ventilation and vapour diffusion within cladding cavity to eliminate remaining water

Durable: Use of components with adequate durability appropriate to the project location

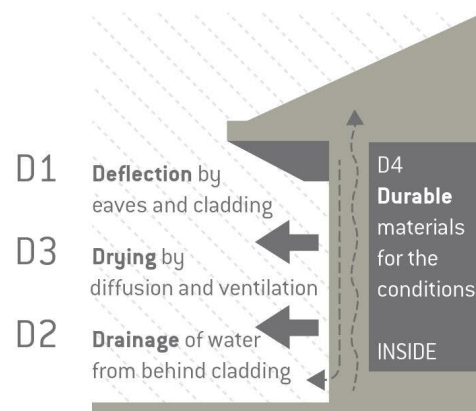

Allowance for adequate ventilation is paramount in ensuring a successful EQUITONE façade. A ventilated façade provides a number of added benefits to the building and its occupants. These may include but are not limited to the following:

- Positive contribution to energy savings
- Assists with condensation management
- Minimises thermal bridges by providing an opportunity for applying external insulation
- Reduces thermal movement of the structure and cladding support frame
- Dissipates radiant heat
- Increases acoustic performance of the external wall
- Provides an effective drainage path for any moisture passing the cladding skin
- Eliminates the need for exposed caulking and sealant, therefore reducing maintenance requirements
- Assists with keeping the weather barrier dry and healthy
- Provides opportunities for concealing external services such as downpipes within the cavity
- Proven to be a more sustainable and healthier façade construction
- Architectural design flexibility

EQUITONE facade

Air must be allowed to enter the cavity from the bottom of the façade, window head, soffit, slab junctions, and the like, and exit from the top of the façade, capping, window sill, slab and soffit interfaces, and the like.

The size of air inlets and outlets depends on the height of the façade and the vertical distance between them. For effective ventilation, the size of air inlet should always be greater than or equal to the size of air outlet.

The following is a general recommendation for the size of air inlets and outlets on a closed joint façade, i.e. where the horizontal joints located between air inlets and outlets are closed (baffled).

Vertical distance between air inlet and air outlet (m)	Min. size of air inlet/outlet (Without a perforated profile) (mm)	Min. size of air inlet/outlet (With a perforated profile with a 50% open area) (mm)
< 5	10	20
< 10	15	30
< 20	20	40
< 50	25	50
< 75	30	60
< 100	35	70

It is recommended that all air inlets and outlets are protected against entry of birds and vermin into the cavity with a corrosion resistant perforated profile (angle). The thickness of the perforated profile placed between the cladding panel and support frame should not exceed 0.8 mm. The open area percentage of the profile and the size of the air inlet and outlet are crucial factors in ensuring adequate ventilation. The minimum ventilation allowance is 100 cm²/m, but this may need to be increased depending on the distance between the air inlets and outlets. The recommended minimum perforation percentage of the profile is 50%. Profiles with less open area result in larger air inlet and outlet sizes. Refer to the above table for the minimum recommended air gap sizes with and without a perforated profile with a 50% open area. The aperture size of the profile is recommended to be between 3 mm to 5 mm*.

The perforations (air inlets and outlets) must be kept open and unobstructed to maintain drainage and ventilation of the cavity. The perforated angle shall be positioned to allow an adequate drip edge to the cladding panel.

At the base of the façade, typically a minimum 150mm above the finished ground/floor level is recommended. This will help prevent rain splash-back from the ground while maintaining sufficient space for the air to enter the cavity. Where rain splash-back effect is not a concern, e.g. in covered areas, the above recommended minimum air inlet sizes provided with respect to the distance between air inlet and outlet apply.

No planting of garden, decorative or ornamental plants should be allowed near the air inlets as over time these may block the air inlets.

Refer to the 'Design considerations' section for information about the required minimum cavity width.

* In bushfire prone areas, the maximum aperture size of the perforated profiles covering air inlets and outlets should not exceed 2 mm. Refer to the 'Bushfire zones' section of the 'Design considerations' part of this document for further information and considerations for applications in bushfire prone areas.

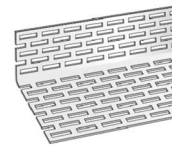
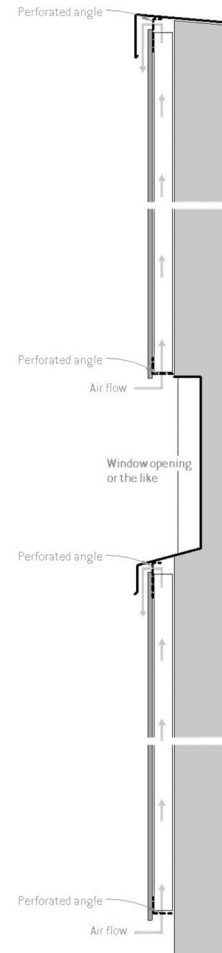

General components

Cladding components

UNI Rivet

EQUITONE is face fixed to metal support frame using colour matched proprietary UNI Rivets. The rivet includes a green gasket which controls the connection depth which is approximately 2.25 mm more than the panel thickness.

With an 11 mm panel hole size and rivet centred in the panel hole, EQUITONE UNI Rivet system provides a 2.25 mm 3-way movement allowance within the connection, providing a stress-free panel fixation.



UNI Rivet is available in the following materials:

- Stainless Steel 304 (A2)
- Stainless Steel 304 (A2) with additional marine and coastal protective coating (recommended for C5 corrosion zones)
- Stainless Steel 316 (A4) (used where higher corrosion resistance level is required)
- Aluminium Almg5 (recommended for fixing to aluminium support frame)

Rivet sizes

For 8 mm EQUITONE panel, and EQUITONE [lines]

Rivet type	Support frame Base Metal Thickness (BMT)
4x18 K15 Aluminium UNI Rivet	1.15 mm to 2.75 mm
4x18 K15 Stainless Steel UNI Rivet	1.1 mm to 3.75 mm
4x20 K15 Stainless Steel UNI Rivet	3.75 mm to 5.75 mm

For EQUITONE [lunara]

Rivet type	Support frame Base Metal Thickness (BMT)
4x20 K15 Aluminium UNI Rivet	1.15 mm to 2.75 mm
4x20 K15 Stainless Steel UNI Rivet	1.1 mm to 3.75 mm
4x22 K15 Stainless Steel UNI Rivet	3.75 mm to 5.75 mm

For 12 mm EQUITONE panel

Rivet type	Support frame Base Metal Thickness (BMT)
4x25 K15 Aluminium UNI Rivet	1.15 mm to 2.75 mm
4x22 K15 Stainless Steel UNI Rivet	1.1 mm to 3.75 mm
4x24 K15 Stainless Steel UNI Rivet	3.75 mm to 5.75 mm

UNI Rivet STOP point gasket

UNI Rivet system is based on a GO (gliding) and STOP (fixed) point principle. The red UNI Rivet STOP point gasket (sleeve) is used to form STOP fixing points.

The red sleeve is placed over the green GO point sleeve of UNI Rivet to form a STOP point.

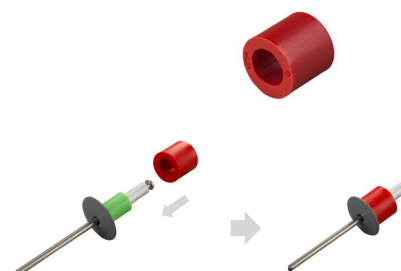

For further information about EQUITONE UNI Rivets and their technical properties, refer to their Material Information Sheets available from local EQUITONE technical department.

UNI Rivet must be used in conjunction with the recommended compressible closed-cell gasket.

There are only two STOP points per panel.

Location of STOP points in a panel is very important. Refer to Panel Fixing Principle and STOP Points Selection Guide for information and guidance on the correct selection of the STOP Points in a panel.

Panel hole size for both GO & STOP points is 11 mm, drilled with 11 mm EQUITONE proprietary bit.

General components

Only two STOP points must be used per panel.

There is a specific size of the STOP point sleeve for each panel thickness. Both EQUITONE [lines] and 8mm EQUITONE panel share the same size, 10mm long, STOP point sleeve whereas with EQUITONE [lunara] and 12mm EQUITONE panels different size sleeves i.e. 12mm and 14mm, respectively, are used.

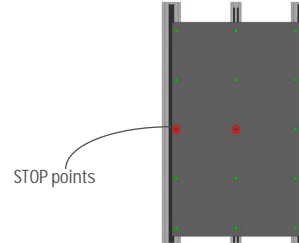

Compressible EPDM gasket

A compressible closed-cell EPDM gasket is used with UNI Rivet fixing system as well as for sealing interfaces with flashings and the like as specified on EQUITONE Construction Details.

- 12mm Tesa® 66703, 12mm Tesa® 61102, or 12mm PVC Tesa® 60106
- 40-48mm Tesa® 66703 (Used mainly for sealing and creating a black expressed panel joint on support frame with flat face)
- 40-48mm Tesa® 66704 (Used mainly for sealing and creating a black expressed panel joint on support frame with a recess on the face to accommodate the gasket)



Baffle

Black coated aluminium baffle is used to form expressed panel horizontal joints.



Recommended weather (resistive) barrier options

Weather barrier option 1

pro clima SOLITEX EXTASANA® flexible air barrier

EQUITONE façade systems have been independently assessed and certified with pro clima SOLITEX EXTASANA® for the purpose of compliance with NCC 2022 F3P1 & H2P2 for the following wind pressures calculated to AS1170.2.

- Serviceability wind pressure: $\pm 2\text{KPa}$
- Ultimate wind pressure: $\pm 3\text{KPa}$

pro clima SOLITEX EXTASANA® shall be applied in accordance with AS4200.2 and pro clima SOLITEX EXTASANA® installation guidelines.



For information about technical properties and correct application of pro clima products, refer to pro clima technical documents, and SOLITEX EXTASANA® Application and Fixing Guides.

For information about Siniat Weather Defence® and its technical properties and application, refer to Siniat technical documents which are available at www.promat.com/en-au.

For further information regarding selection of appropriate weather barrier, refer to Design Considerations section of this document.

General components

Weather barrier option 2

Siniat Weather Defence® rigid air barrier

EQUITONE façade systems have been independently assessed and certified with Siniat Weather Defence® for the purpose of compliance with NCC 2022 F3P1 & H2P2 for the following wind pressures calculated to AS1170.2.

- Serviceability wind pressure: $\pm 2.5\text{KPa}$
- Ultimate wind pressure: $\pm 4.5\text{KPa}$

Siniat Weather Defence® shall be applied in accordance with Siniat Weather Defence® installation guidelines.



Weather barrier components

Flashing tape
pro clima TESCON EXTORA®

A pressure sensitive adhesive tape for overlaps, end laps and taping on to flashings and the like. Used with both weather resistive barrier options.



Sill tape
pro clima TESCON EXTOSEAL®

A flexible tape for use around window and door openings, used with both weather resistive barrier options.



Sealing tape
pro clima TESCON® NAIDECK mono patch

A single-sided adhesive nail or screw sealing adhesive used with both weather resistive barrier options.



Foil tape
pro clima TESCON® ADHISO WS

A pure aluminium tape for wet seal connections to TESCON EXTOSEAL® and EXTORA® and SOLITEX EXTASANA®.



Grommet
pro clima ROFLEX and KALFEX

pro clima ROFLEX is used to seal pipe and pro clima KAFLEX for cable penetrations. pro clima ROFLEX and KALFEX are used with both weather resistive barrier options.



PRESSFIX
A malleable plastic tool for applying pressure to pro clima Adhesive TESCON® Tapes to ensure long term durable bonding.



¹ Foil tape is optional and not required when using sealants which are compatible with TESCON EXTOSEAL® and EXTORA® and SOLITEX EXTASANA®. Check with the sealant manufacturer for compatibility with pro clima products.

General accessories

EQUITONE saw blades

These blades have been designed especially for cutting high density fibre cement panels, and when correctly used, result in a high level of finish. The blade is unique with its minimal diamond tipped teeth which are shaped to give a tear-free edge, and its vibration damping composite body construction. These blades can remain good for up to 5,000m of cutting providing it is correctly used. The blades are available in the following sizes:

- 160 mm diameter with 4 diamond tipped teeth and 20 mm centre hole diameter
- 190 mm diameter with 4 diamond tipped teeth and 30 mm centre hole diameter
- 225 mm diameter with 6 diamond tipped teeth and 30 mm centre hole diameter
- 300 mm diameter with 8 diamond tipped teeth and 30 mm centre hole diameter



Jigsaw blade (for curved cutting only)

Bosch T141HM jigsaw blade is recommended for curved cut-outs. It is available in a pack of three.



EQUITONE 11 mm drill bit

These are specially designed fibre cement drill bits for drilling the holes in the panels. This drill bit is a fully hardened steel bit with a cutting edge to suit fibre cement. This drill bit reduces risk of sliding on the panel surface, provides a clean cut with no burrs and does not cause burning. This results in a drill bit with a very long life.



EQUITONE centralising tool

This tool is used to ensure the 4.1 mm rivet hole in the support frame is centred in the 11 mm panel hole. This ensures the best allowance for any frame movement. The tool has a guide that neatly fits into the panel hole. The 4.1 mm drill bit then extends to drill the profile. The drill bits can be easily replaced at the end of their functional life. This accessory fits any standard manual or electrical drill and is used with all EQUITONE panels which are to be fixed to a metal supporting frame with UNI Rivet.



EQUITONE centralising tool 4.1 mm replacement bit

Centralising tool replacement bits are available in a pack of 5.



EQUITONE rivet setting tool *

This accessory fits onto rivet gun and helps prevent scratching rivet head and panel during fixing operation, and it ensures the correct placement of rivet perpendicular to supporting frame and panel. It is available in the following options:

- Rivet setting tool for stainless steel UNI Rivet
- Rivet setting tool for aluminium UNI Rivet



* Not applicable to EQUITONE [lines]

Accessories

Material specific accessories

EQUITONE [lines] mill and drill tool

This accessory has been designed for milling and drilling EQUITONE [lines] when face fixed. The tool is equipped with built-in 11 mm bit and milling blades to both drill an 11 mm panel hole and mill the panel ridge in one operation.



LUKO edge sealer for EQUITONE [natura] & EQUITONE [natura] PRO¹

LUKO is a translucent liquid sealer that is applied to the cut edges of [natura] and [natura] PRO panels to help prevent moisture ingress in the panel. It is available in 0.5, 1, and 10 litre containers. Depending on the application, 0.5 L of LUKO could cover up to 500 linear metres of panel edge.



LUKO application kit for EQUITONE [natura] & EQUITONE [natura] PRO¹

A LUKO application kit, including an applicator and tray, is available to assist with the correct application of LUKO. Replacement sponges are also available.

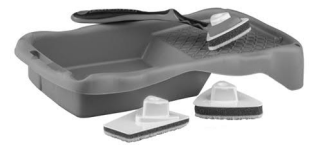

¹ It is also possible to apply LUKO to the cut edges of [pictura] to prevent any possible risk of whitening of the edges (efflorescence).

Support frame

General support frame options

EQUITONE may be face fixed to any engineered metal support frame. The common frame types are galvanised or aluminium-zinc alloy coated steel, stainless steel, and aluminium profiles. Generally, wider profiles are used behind panel vertical joints while a narrower profile is used as intermediate profiles in the middle of the panel. The following provides general minimum specifications for the support frame.

General specifications of cladding support frame:

Minimum profile thickness (Base Metal Thickness)	Steel	≥ 1.1 mm
	Aluminium	≥ 2.0 mm
Recommended minimum width of intermediate profile		40 mm
Recommended minimum width of vertical joint profile		120 mm
Recommended maximum length of profile		3.2 m

Top hat or omega profiles

The most common support frames are top hat profiles. These are generally used on standard lightweight steel stud, masonry, or concrete substructures. Depending on the substructure type and arrangement as well as the required cavity width, a single or double layer top hat construction may be used.

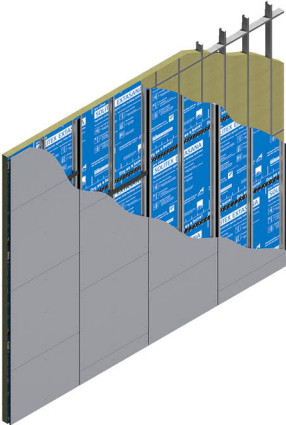

Isometric view of single layer top hat construction

Single layer top hat construction

This is used where the substructure is engineered to directly support vertical top hat profiles (cladding support frame). If this support frame arrangement is intended to be used on a lightweight steel stud wall frame, it needs to be ensured that the horizontal noggins of the wall framing are specifically engineered and structurally adequate to support the cladding support frame, as the noggins are normally non-structural and designed for bracing purposes only.

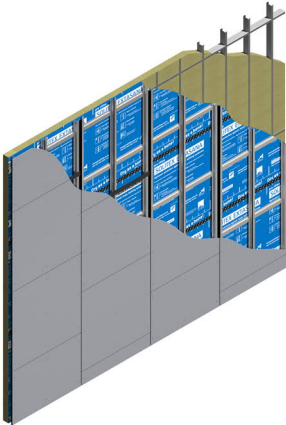
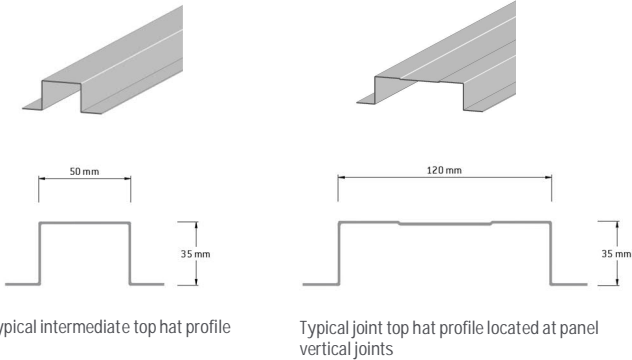

Isometric view of double layer top hat construction

Double layer top hat construction

This is the most common support frame arrangement, particularly where the substructure cannot directly support the cladding vertical support frame. Generally, in this case a layer of horizontal top hats (min. 15 mm deep) is first used and fixed to the substructure. The vertical top hats (min. 25 mm deep) to which EQUITONE is installed are then fixed to these horizontal top hats.

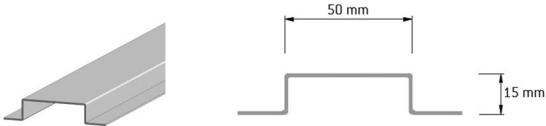

 It is advisable to use a vertical profile that allows for some degree of installation tolerance.

Support frame should have adequate corrosion resistance appropriate to the location of the project. It is the responsibility of project engineer or designer to determine the level of corrosion resistance and suitable support frame with adequate corrosion resistance required for the intended application.

Minimum typical cavity width (depth) is 35 mm. Where smaller cavity width is required, consult with your local EQUITONE technical department.

Metal support frame profiles should be compliant with AS/NZS 4600 – Cold-formed steel structures and/or other applicable standards.

Maximum deflection of support frame must be limited to Span/250.

Support frame



For further information about NVELOPE components and product specifications, refer to the supplier of NVELOPE systems.

The application of NVELOPE systems shall be in accordance with its supplier's recommendations and guidelines.

Aluminium bracketry framing system

This type of support frame generally comprises vertical rails, to which cladding is fixed, and brackets connecting the vertical rails to the substructure. NVELOPE offers a range of aluminium bracketry systems commonly used with EQUITONE.

NVELOPE brackets are available in various depths suiting different or varying cavity widths from 50 to 300 mm.

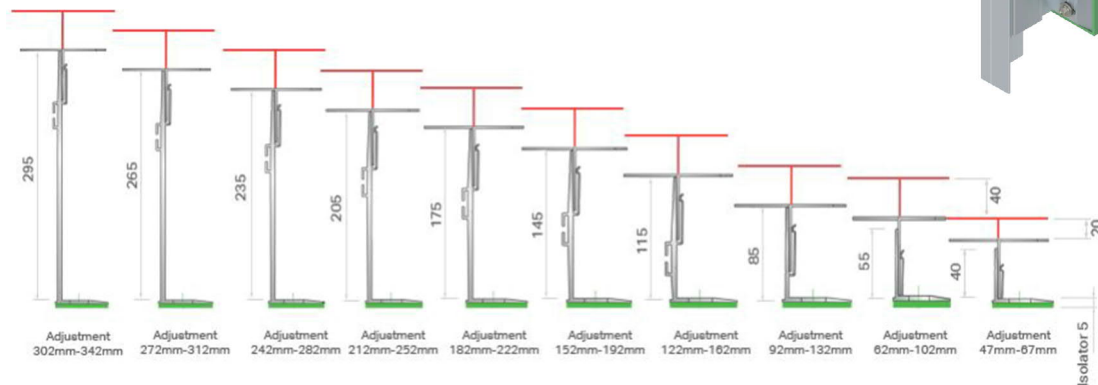

NVELOPE brackets suiting various cavity widths

The vertical rails are generally available in 'L' & 'T' sections.

- Minimum face width of 'T' rail (located at panel vertical joints): 120 mm
- Minimum face width of 'L' rail (intermediate support profile): 40 mm



NVELOPE also offers a proprietary thermal isolator gasket, with an R-value of 0.04, suiting NVELOPE brackets to reduce thermal bridging.

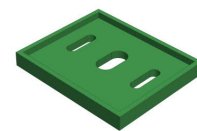

NVELOPE thermal isolator

Instances where a bracketry framing system may be used include, but are not limited to, the following:

- Where cladding cavity width varies either due to design or uneven substrate
- Where a wider cavity is required
- Where external insulation is intended to be used
- Where vertical movement allowance within the connection of cladding framing and substructure is required e.g. where cladding framing bridges over a horizontal control joint, for instance at floor junctions, and needs to be fixed to the substructure on both sides of the joint. In this case, this type of framing may be used provided that the size of the elongated holes of the brackets suits the required movement allowance

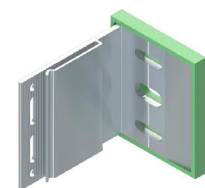

Example of NVELOPE bracket with thermal isolator

Panel storage

General requirements

EQUITONE panels must be stored flat on pallets, inside and undercover in dry conditions, protected from weather and potential influence of other trades. Store products clear of the ground and on level bearers at a maximum of 600mm centres.

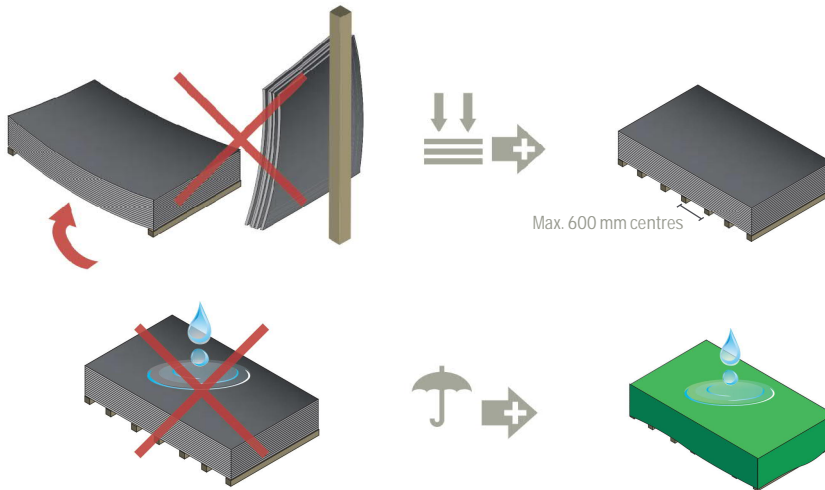

Before installed ventilated, EQUITONE panels must not get wet.

Do not deliver any panels to site which cannot be installed immediately or unloaded into a suitable well protected storage area.

EQUITONE is a prefinished material and poor or inadequate storage will increase the risk of damage to the finished surfaces.

Outside storage

Where panels must be stored outside, extra care and attention is needed to protect them from rain and direct sun. Remove the outer plastic protection as this may cause condensation if left in place especially in direct sunlight.

Protect the pallet from rain or condensation by covering the pallet with an opaque waterproof cover like tarpaulin. This cover must be provided with a slope, so all moisture runs off quickly and must not be allowed to pond on the pallets. This will also allow the air to circulate around the panels. Use only opaque coverings. Clear plastic is not recommended.

If moisture can penetrate between the stored panels, permanent surface staining in the form of efflorescence may occur and may prevent the panels being used.

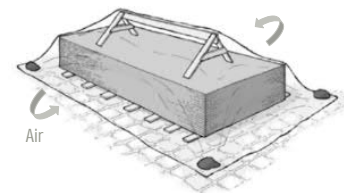

Other trades

Be aware of other trades on the job site as they may not respect the material in the same way.

Do not leave material in such a way that allows people to walk over the panels as this will leave footprints on the surface.

These prints may scratch the panels or leave an oily residue on the surface, which could permanently stain the panel.

It is advisable to barricade the storage area and workstation around the panels to reduce any risk of damage by other trades.

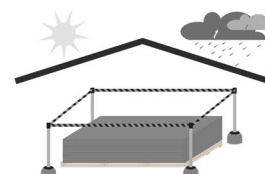
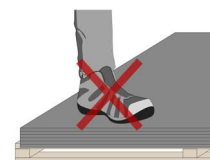

Panel storage

Panels on edge

When storing EQUITONE panels on their edges, use soft supports such as pieces of insulation or rubber faced timber battens to rest the edge on. This can help prevent chipping or edge damage.

Only leave panels stored on their edge for a short time (maximum 1 hour) and never in wet weather. Standing the panel on its edge is not a long-term method of storage and may cause deformation.

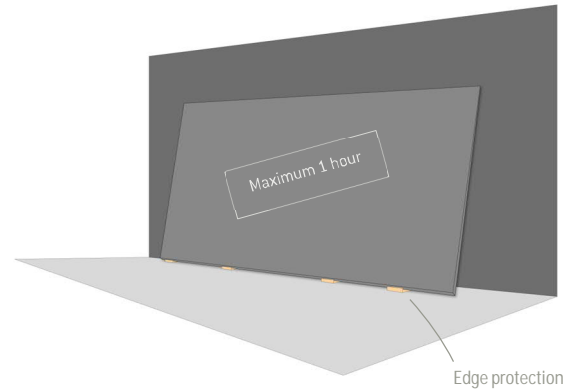

Stacking panels

EQUITONE [natura], [natura] PRO, & [pictura]

These EQUITONE panels are supplied with protective film between the decorated faces. This inter-film must not be removed.

When restacking these panels:

- Stack the panels front-face-to-front-face or back-surface-to-back-surface. The panels should not be placed face-to-back.
- Reuse the film between each layer which is face-to-face to prevent scratches.

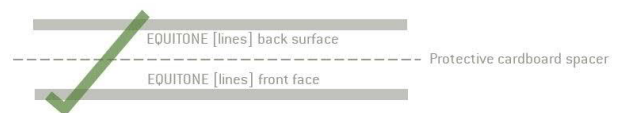
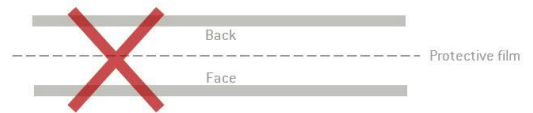

EQUITONE [lines]

EQUITONE [lines] panels are stacked front-face-to-back-surface with a protective spacer in between. Only the first two top panels on a pallet are positioned front-face-to-front-face to reduce the risk of damage to the top panel face during transport and storage, while the rest of the panels on a pallet must be stacked front-face-to-back-surface.

EQUITONE [tectiva] & [lunara]

EQUITONE [tectiva] and [lunara] panels may be stacked front-face-to-back-surface with no protective spacer or film in between the panels.

Pallets

Pallets are to be kept in a good condition. Damaged or broken pallets increase risk of damage to the panels.

When sorting from one pallet to another ensure that the timber pallets are oversized or larger than the panels to prevent possible damage to the panel edges.

Individual pallets can be 500mm high, and not more than 5 pallets can be put on top of one another provided the ground is flat and level.

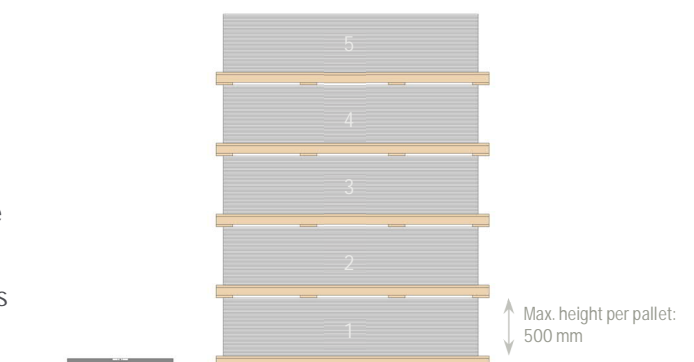

Panel moving

Lifting

Moving panels that are stacked on pallets should be done with a forklift or a crane.

Ensure the panels are secured to the pallet in a way that will not cause damage. Soft protection is needed where straps touch the panels.

Stacks should be transported under a waterproof cover.

When lifting with straps, position them so the panels are balanced and there is no risk of tipping over. Use wide straps or edge protection to prevent damage.

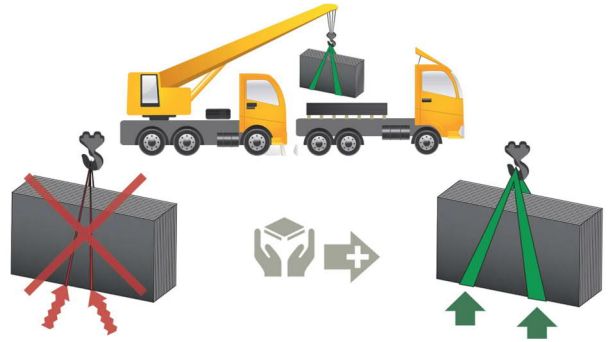

Forklift

When moving the pallets with a forklift, it is recommended that a multi-fork attachment (4 forks) is used.



If using the standard 2 fork attachment, these must be positioned with a wide setting. This will stop the pallets bending when lifted.

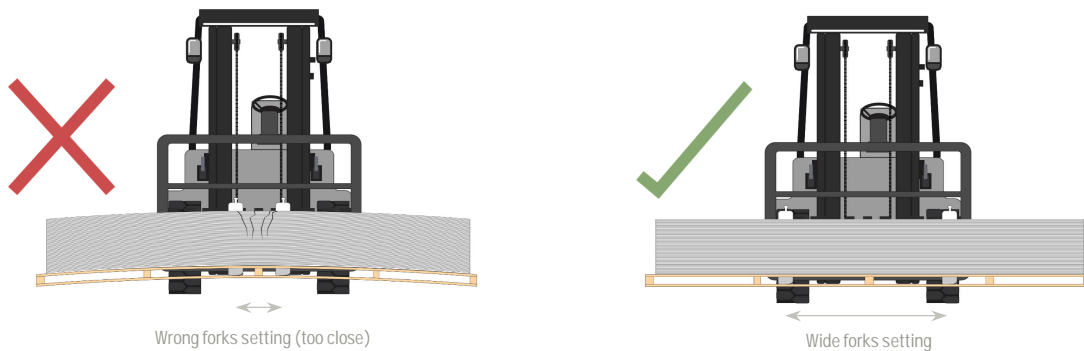

Panel handling

Handling

Plan carefully how the panels will be handled. Decide on a suitable route for moving the panel from the storage area to the facade and then up the façade. Be aware of obstacles such as scaffolding, temporary supports or uneven walking surfaces.

Always lift panels off each other, never slide them over one another, since scratching may occur on the surface.

To carry the panels, stand them on their back edge on soft bearers and lift with two people, one person at each end, protecting the panel face from scratching or damage.

Always lean the panel towards its back edge to avoid damaging the visible front edge.

Always respect Health & Safety guidelines in all aspects of manual handling.

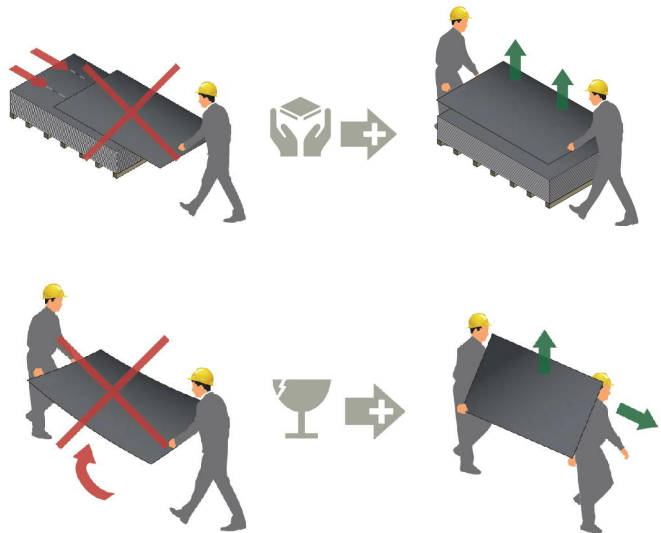

Suction lifters

When suction lifters are used to lift and move panels, it is important to ensure they are strong enough. Only suitable with the smooth surface panels.

However, there is a high risk of leaving marks on the panel and therefore a test needs to be carried out to ensure the suction cups do not leave any marks on the panel surface e.g. because of the rubber's oily surface. The suction cups must be perfectly clean.



Carrying Straps

To ease the lifting of large panels, carrying or manual lifting straps can be used. Make sure the strap material will not damage the panel edges. Take care when removing the straps.



Gloves

Clean gloves must be used to prevent fingerprints on the panels. Gloves should be of a type that ensures good grip and are easily cleaned. Make sure the gloves are waterproof if working in damp or wet weather and will not cause any risk of cement dust reaching the skin as this may cause irritation.

At times when working with white EQUITONE panels wearing cotton work gloves prevents staining. Make sure gloves are always clean.

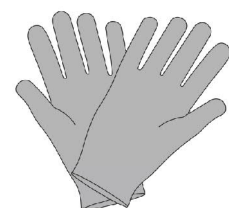

Panel preparation

Tools & accessories

General tools and accessories required for panel preparation are as follows. The following list is by no means exhaustive.



EQUITONE blade for manual cutting



Bosch T141HM jigsaw blade for curved cuts



EQUITONE 11 mm bit for panel drilling

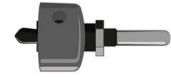

EQUITONE drill & milling tool for drilling EQUITONE [lines]



80 grit sandpaper for sanding panel edges (to be affixed to a timber block)



LUKO sealer & LUKO applicator kit for edge sealing of EQUITONE [natura] & EQUITONE [natura] PRO



Paper towel for removing any LUKO residue



Clean microfibre cloth for dust removal



Measuring tools & pencil for marking

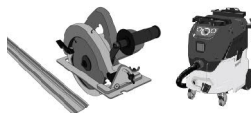

Saw, guiderail, & vacuum for panel cutting



Jigsaw for curved cut-outs



Drill for panel drilling

Health & safety

As with all products containing quartz, e.g. concrete and clay, when EQUITONE panels are machined mechanically (cutting, sanding, drilling) the released dust may contain quartz particles. Inhalation of high concentrations of dust may irritate the airways, and dust may also cause irritation of eyes and/or skin. Inhalation of dust containing quartz, especially fine (respirable size) particulate matter, in high concentrations over prolonged periods of time, can lead to lung disease (silicosis) and an increased risk of lung cancer.

- Avoid dust inhalation with the use of cutting/sanding equipment fitted with dust extraction/suppression accessories wherever practical
- Ensure adequate ventilation of all work sites
- Avoid contact with eyes and skin by wearing an approved respirator (a dust mask compliant with AS/NZS 1715 and AS/NZS 1716) together with appropriate personal protective equipment (safety glasses, hard hat, boots, and protective clothing)



Refer to EQUITONE Material Safety Data Sheets (MSDS) for more information about health and safety, including common hazards associated with working with EQUITONE, and measures to minimise risk.

Panel preparation



Where untrimmed panels are used, panels must be trimmed before installation.

Refer to Material Information Sheet for trimming procedure.

Untrimmed EQUITONE panels must NOT be used on a façade. Any untrimmed panel used on a façade will render the EQUITONE warranty void. Any claim or complaint relating to the use of untrimmed panels will not be accepted.

Panel cutting

It is recommended that cutting of the panels is carried out off site as much as possible. In situations where this is not possible, on site cutting may be done.

EQUITONE saw blades

EQUITONE saw blades are recommended to be used for cutting the panels. The following table provides the recommended saw speeds with respect to the blade sizes.

Blade Diameter	Blade thickness	Borehole	No. of teeth	Saw Speed (rpm)
160mm	3.2mm	20mm	4	4,000
190mm	3.2mm	20mm	4	3,200
225mm	3.2mm	30mm	6	2,800
300mm	3.2mm	30mm	8	2,000



Cutting procedure

When using portable saws, EQUITONE panels are normally placed face down and the cutting is from the back side. Therefore, it is important that the workbench has a clean and soft material covering it to prevent scratching and marking of the panels.

The blade should be set to extend approximately 5mm below the panel to allow the debris material to escape.



Only one panel should be cut at a time. Do not cut multiple panels together at the same time.

The panel should be held firmly in place to avoid vibration.

Do not cut the panel by allowing the panel to overhang the edge of the work bench as this will damage the edge.

When cutting the panel, it is advisable to place the panel on a solid workbench preferably indoors or under cover. This will reduce the risk of staining from damp/wet weather and makes dust cleaning easier.

Ensure the level of the workbench is set at a comfortable height to allow safe use of the saw and to prevent over stretching by the operatives. Due to the large number of variables, trial cutting on a waste piece of panel should be carried out to determine the optimum saw setting and movement speed of the saw.

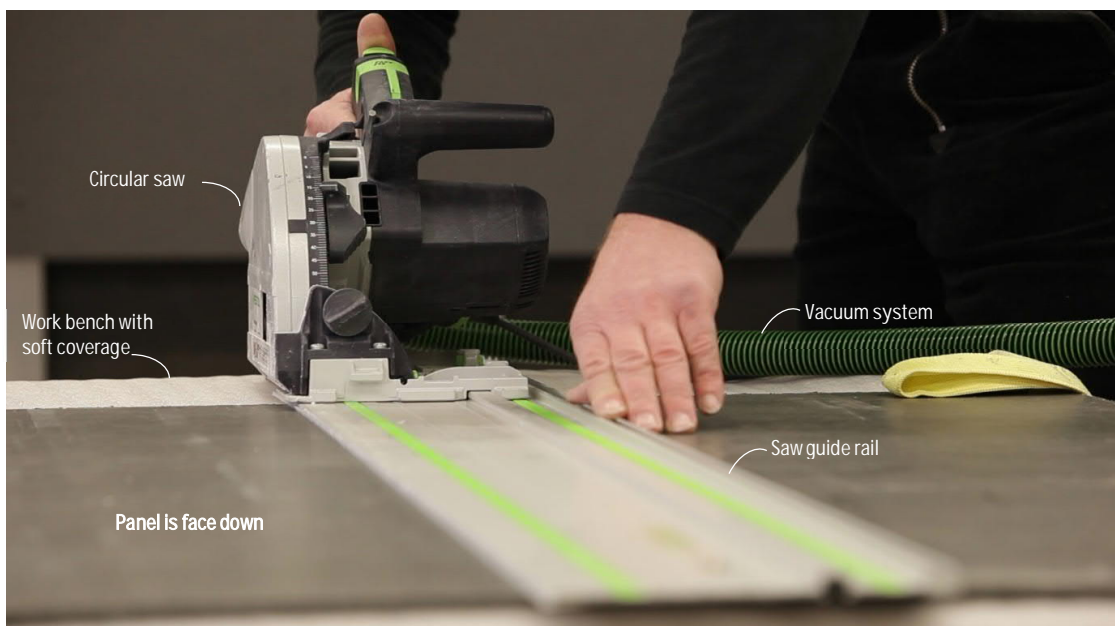

Panel preparation

Cutting equipment

Various types of equipment or machinery may be used for cutting EQUITONE panels. These may include portable saw e.g. circular saw, flat-bed horizontal or vertical (wall) saw, and CNC and waterjet machine. The following needs to be noted when considering different types of cutting equipment or machinery.

- Each cutting procedure, equipment or machinery may produce a different edge finish
- Where waterjet is used for panel cutting, panels must be fully dry before they can be stacked or packed
- Panel must be positioned such that cutting is conducted into the panel face to reduce the risk of chipping the edges



Curved cut-outs

For curved cuts or cut-outs –

- place the panel face down (ensure there is a soft coverage on the workbench to protect the panel face),
- drill a hole in the panel at the edge of the intended curved cut-out area,
- ensure jigsaw pendulum function is switched off, and
- insert Bosch T141HM jigsaw blade and proceed to cut.

Due to the length of the blade, space must be provided under the panel to allow the blade to work.



Finishing cut edges

Panel edges should be sanded after cutting them. This reduces the possibility of damage and improves their appearance.

Use 80 grit sandpaper secured to a block of wood, approx. 400 x 100 mm in size. Using a small timber block may result in uneven sanding.

Do not use sanding pads, sponge blocks, or sandpaper without a hard backing, as these may cause curving of the edge finish.

To speed up the sanding process and chamfer the edges at the same time, cut a groove from a block of timber and carefully wrap sandpaper into the groove.



Cleaning after cutting

Immediately after cutting, clean off all dust with a dry, clean microfibre cloth. Keep the cloth free of grit. Only use cloth for cement dust removal. Clean cloth regularly.

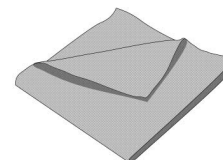

Poorly maintained cutting tools or incorrect saw speed as opposed to blade speed can result in localised heating/ burning of panel edges.

Do not use grinder tools as these usually have a high cutting speed. This produces higher than average pressure on panel edges. Most grinding tools also produce excessive, unwanted dust.

Panel preparation

Panel drilling

Panels should be drilled using the **EQUITONE 11 mm drill bit**.

Ensure the panel is positioned face up, and that the drill is held perpendicular to panel face.

When drilling a panel, it is advisable to place it on a solid workbench preferably indoors or under cover. This will reduce the risk of staining as a result of damp/wet weather.

Drill only one panel at a time. Do not drill multiple panels at the same time to ensure accurate positioning of panel holes.

The panel should be held firmly in place to avoid vibration. Turn off the hammer-action function on the power-drill as this can cause the drill to move and slip.

Do not drill any panels in situ on a façade.

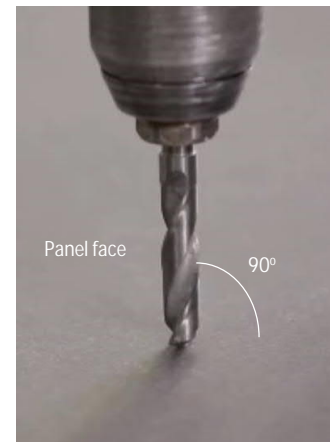
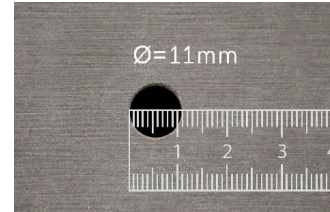

Other machinery

Panel holes may be drilled with other machinery such as CNC machines provided that the hole size is ensured to be 11 mm. Smaller size hole reduces the movement allowance within the connection, and larger hole reduces the pull-through (structural) capacity of the connection.

Waterjet is not recommended for drilling panel holes.

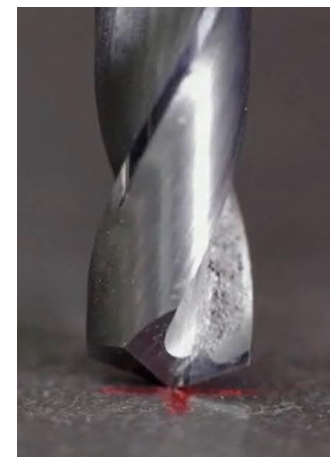

Marking the position of holes

When marking the position of the panel holes, being accurate and using small crosses will reduce cleaning time.

Use a coloured pencil such as white or red to highlight the hole position especially on grey or dark grey panels. It is possible that a grey pencil mark will be lost in the fibre pattern on the panel's surface.

Do not use chalk line and permanent markers.

Cleaning after drilling

Immediately after drilling, clean off all dust with a dry, clean microfibre cloth. Keep the cloth dry and free of grit. Do not use a wet cloth as staining may occur.

Only use cloth for cement dust removal. Clean cloth regularly.

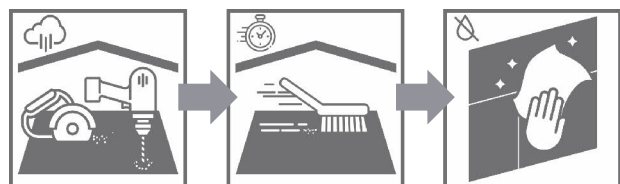

Panel preparation

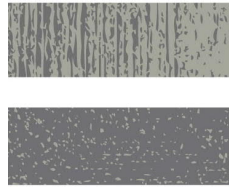

Drilling EQUITONE [lines]

EQUITONE [lines] features a grooved surface. For face fixing of the panel with UNI Rivet, the ridges need to be milled where the rivet will be located so that the rivet sits flat on the base of the groove.

EQUITONE [lines] drill and mill tool (EQUITONE milling tool) must be used for drilling and milling the panel. The tool is equipped with built-in 11 mm bit and milling blades to both drill the panel hole and mill the ridge in one operation.

The panel hole and fixings can either be in between or aligned with the panel ridges.

From an aesthetic point of view, when drilling the EQUITONE [lines] it is recommended to align the fixings with the ridges of the panel for the panel fixings to be the least visible.

The depth of the panel ridge (Y) is approximately 2 mm. The black plastic ring part of the tool is adjustable in depth. Adjust so that the milling blades protrude out of the ring by as much as the depth of the ridges to not over- or under- mill the panel.

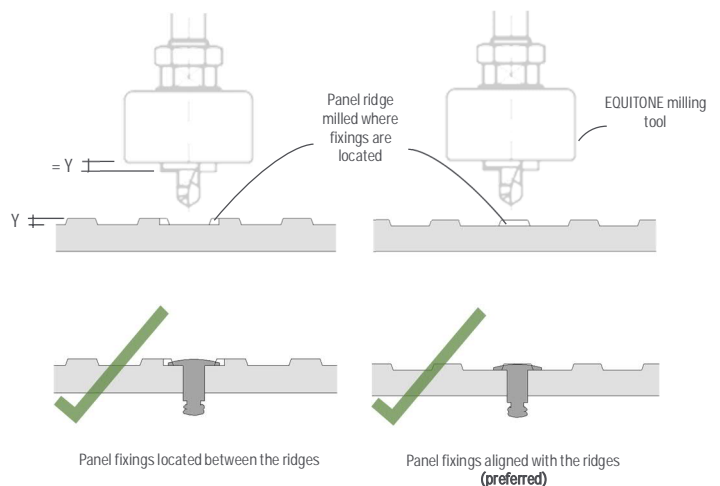
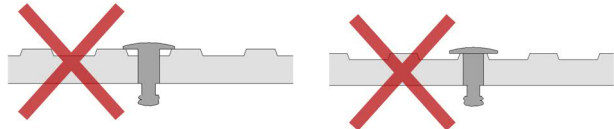
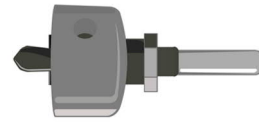
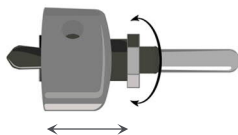

Application of EQUITONE milling tool

- Place a sacrificial fibre cement sheet on a solid, stable workbench
- Lay EQUITONE [lines] panel flat on the sacrificial fibre cement sheet
- Mark the location of the holes
- Place the milling tool on the hole position
- Ensure holding the drill perpendicular to panel face during the operation
- Hold the panel firmly in place to prevent panel movement during the process
- Start drilling while applying and maintaining consistent gentle pressure (it is recommended to start drilling with a low speed setting of the drill to engage the bit with the panel before increasing the speed to approx. 650-850 RPM for milling the ridges)

Note that depending on the consistency of the application, some minor chipping of the ridges may be expected.

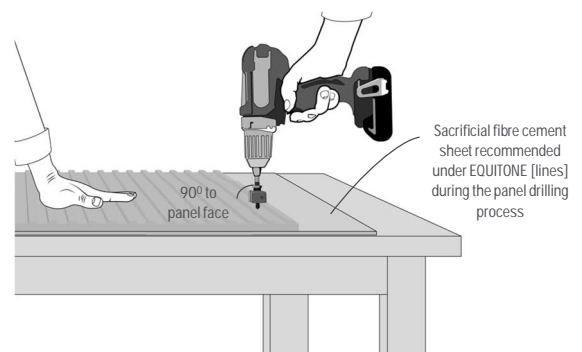
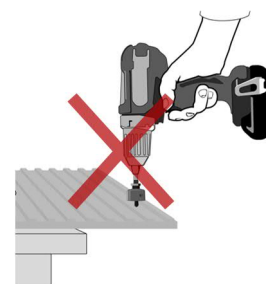

Panel preparation

Panel holes edge distance



For information about spacing of panel holes or fixings, refer to EQUITONE Span Tables section of this document.

Do not drill panels on a façade. Drilling must be conducted on a solid workbench prior to positioning the panel on façade.

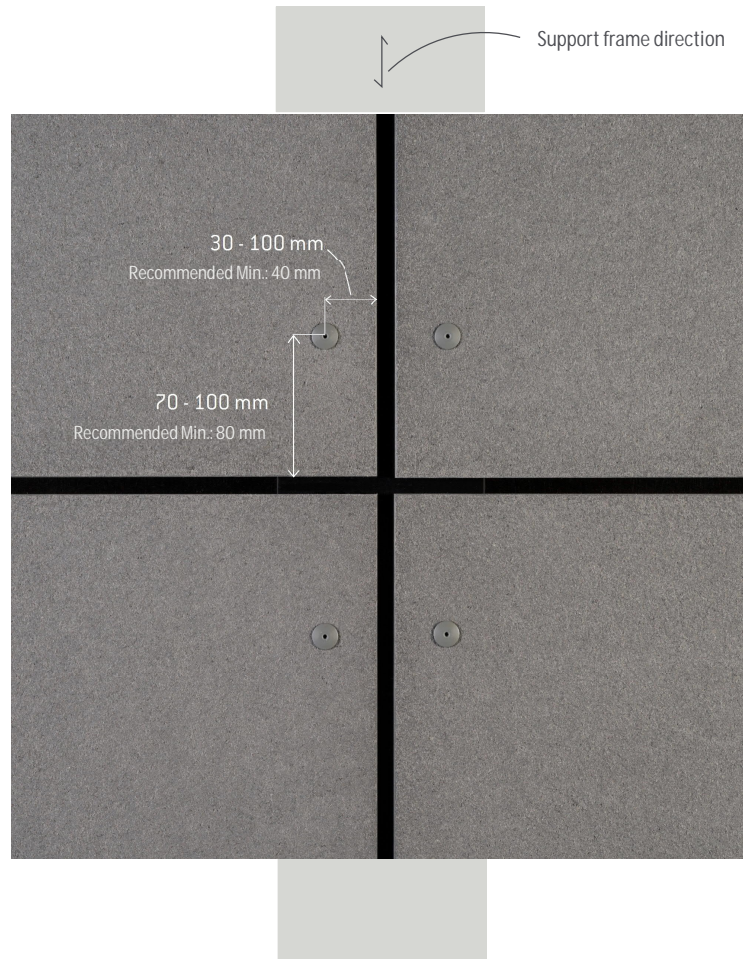

Distance from the panel edge parallel to support frame profile:
(On a vertical support frame, this means the distance from the panel side or vertical edges)

30 to 100 mm
Minimum recommended: **40 mm**

Distance from the panel edge perpendicular to support frame profile:
(On a vertical support frame, this means the distance from the panel top/bottom or horizontal edges)

70 to 100 mm
Minimum recommended: **80 mm**

Notes:

- All measurements are from the centre of the panel hole
- The above minimum recommended distances (40 and 80 mm) are to allow for some degree of tolerance for drilling
- The recommended panel fixings edge distances provided in this section apply to both wall and soffit/ceiling applications

Panel preparation

EQUITONE [natura] edge treatment

With semi-transparent coatings like those used on EQUITONE [natura] and [natura] PRO panels, moisture ingress at the panel edges and predrilled holes can become apparent. In wet weather, the edges of the panel and its penetrations can assume a darker shade (picture framing). Picture framing disappears when the moisture evaporates and the panel dries. This phenomenon is a temporary condition that does not affect the physical characteristics of the panel. The length of time it takes for such phenomenon to cease depends on the seasonal weather trends and conditions. Picture framing does not constitute a defect.

To help prevent this phenomenon from occurring, the edges of all factory cut EQUITONE [natura] and EQUITONE [natura] PRO panels are impregnated with LUKO edge sealant at the factory. The edges of EQUITONE [natura] and EQUITONE [natura] PRO panels that have been cut on-site must then also be impregnated with LUKO.

Do not apply LUKO in wet conditions or after the panel has been fixed.

Edge treatment procedure
Cut, sand, clean and LUKO.



After sanding the edges of the panel, remove all dust from the edges.

1



Apply the LUKO between +5°C and 25°C.
Treat one panel at a time.



Simply pour only enough LUKO into the clean tray that can be used within 30 mins.
Do not pour any leftover LUKO back into the container.



Use the sponge applicator by dipping into the liquid and removing any excess.
Do not move the applicator over the surface of the panel as any drips will be seen and cannot be removed once dried.



Starting at one side of the panel, angle the applicator away from the face of the panel.
Simply run the applicator along the edge.
Ensure full coverage of the edge.
Repeat the process if necessary.



Immediately wipe away any excess that appears on the panel surface. Failure to do so will result in a stain that cannot be removed.
Use a different colour cloth or recyclable paper towels – Do not use micro fibre cloth that was used to remove the dust.
Do not reuse a cloth as it may cause permanent streak marks and staining.
Allow the applied LUKO to dry before manual handling of the panel.



Ensure the cut edges are sanded and free of any dust before the application of LUKO.

LUKO must be applied with appropriate recommended applicator.

Panel must be positioned flat and face up for LUKO edge treatment.

Any LUKO excess on the panel face must be carefully and thoroughly wiped away. Failure to do so will result in stain that cannot be removed.

Allow for the applied LUKO to dry before manual handling the panel.

For Health and Safety, refer to LUKO Material Safety Data Sheet prior to using LUKO.

Do not re-use a cloth to wipe away any LUKO excess as otherwise it may cause permanent streak marks on the panel face. Use clean microfibre cloth or soft paper towel.



Panel installation

Tools and accessories

General tools and accessories required for panel installation are as follows. The following list is by no means exhaustive.



EQUITONE centralising tool & 4.1mm replacement bit



EQUITONE UNI Rivet setting tool



UNI Rivet & STOP point gasket (2 STOP points per panel)



Recommended EPDM compressible gasket



Perforated profile



Baffle for baffled horizontal joints



Battery operated rivet gun e.g. Gesipa Accubird (pro)



Drill



Metal snips for cutting perforated profile, baffle, and flashings



Leveling tools



Shims & packers as required



Clean microfibre cloth for dust removal



Measuring tools



Pencils for marking



Knife

Panel installation

Panel horizontal joints

Depending on the project design requirements and weather barrier type, the horizontal joints may be open or closed (baffled).

Open joints

By leaving the horizontal joints open, the likelihood of dirt spoiling the facade reduces as the joint remains clean. The open joints also function as additional ventilation openings.

Consider the colour choice of the support frame, any external insulation, and/or weather barrier as these may be visible through the open joints. These components may need to be concealed using appropriate black profiles, paint or tape.

A rigid weather barrier is required for an open joint façade.

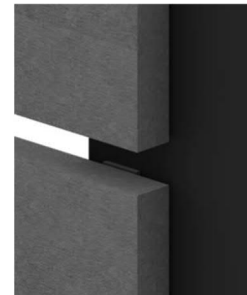

Baffled joints

When a horizontal joint is required to be closed, a metal joint profile (baffle) of maximum 0.8mm thickness can be inserted behind panels. The baffle should have adequate corrosion resistance appropriate to the project location.

By using a baffle, most of the water is prevented from entering the cavity. In some buildings it is advisable to have closed joints, such as the low areas of public or educational buildings. The joint profile will prevent debris from being deposited behind the panels. In the case of kindergartens, baffles will prevent small fingers from getting stuck in the joints.

Where a flexible (pliable) weather barrier is used, horizontal joints are required to be baffled.



Note: Caulking or sealing the joints with sealant is not recommended as the applied sealant may deteriorate in time and cause staining and maintenance issues.

Baffle installation

Cut the baffle approximately 4 mm shorter than the panel width so that it does not cross and become visible at the vertical panel joints.

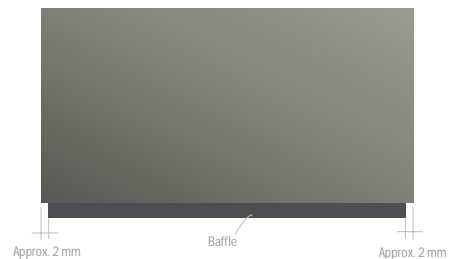

Slide the baffle under the panel. The baffle is then held in place between the EPDM gasket and the panel.

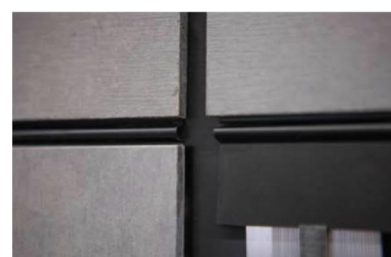

Panel installation

To prevent sideways movement of the baffle, and exposing that movement at vertical joints, cut and bend top or bottom edges of the profile at both sides of one of the vertical support frame profiles. Alternatively, the baffle may be fixed to one of the support frame profiles with a flat head screw sitting flush with the profile face.

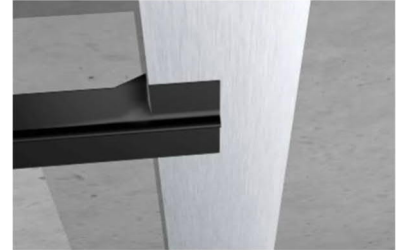

Panel vertical joints

Vertical joints are backed with a continuous support frame profile and/or backing strip or EPDM compressible gasket, forming an expressed joint.

While EPDM gasket generally has a high UV resistance, the part of it visible from the joints and exposed to UV may be subject to some degree of deterioration in time, which could be aesthetically unappealing. A coloured metal strip with maximum thickness of 0.8 mm may be alternatively used to form an expressed joint, in which case the recommended EPDM gasket strip is applied to both sides of the vertical joint in between the panels and metal strip.

Refer to EQUITONE Construction Details documents for further details and vertical joint options.

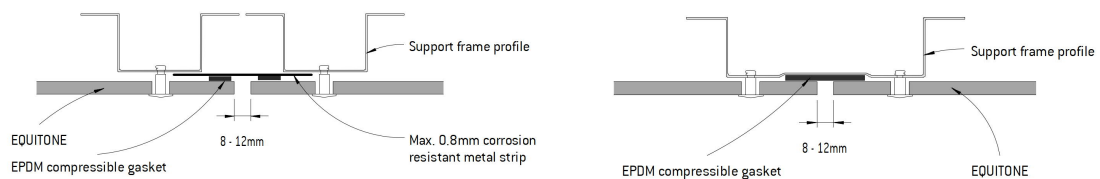
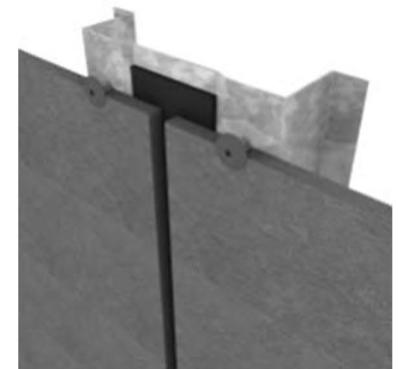

Panel installation

Typical joint width

Many years of practice have shown that the optimum width of the joints between large panels is 10mm. This also offers the installer a reasonable level of tolerance when setting out the frame and fitting the panel.

- The minimum recommended joint width: 8mm
- The maximum recommended joint width: 12mm

Where smaller or larger joint width is required, consult with your local Etex Exteriors ANZ technical department.

Staggered vertical joint

With staggered vertical joints, it is important to align the intermediate panel fixings with the edge fixings of one of the top/bottom panels if the support frame profile located at the joints has a recessed face. Panel fixings must not be positioned in the recessed part of the support frame profile.

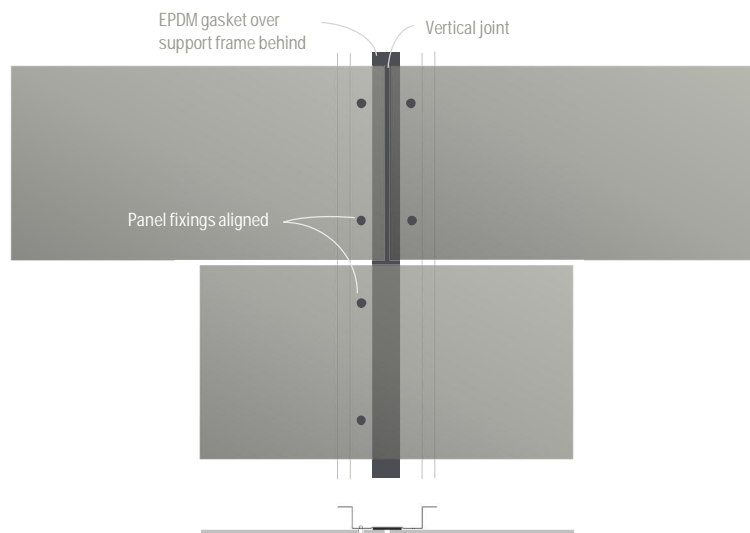

Panel installation

UNI Rivet fixing principle

UNI Rivet system is based on GO (gliding) & STOP (fixed) point principle.

The red sleeve is placed over the green GO point gasket of UNI Rivet to form a STOP point.

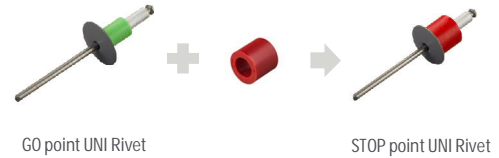

EPDM compressible gasket

UNI Rivet green gasket controls the depth of the connection. It provides an approximate 2.25 mm gap between the panel and support frame. The recommended EPDM closed-cell, compressible gasket is applied in between the panel and support frame to prevent rattling while allowing for movement in depth within the connection.

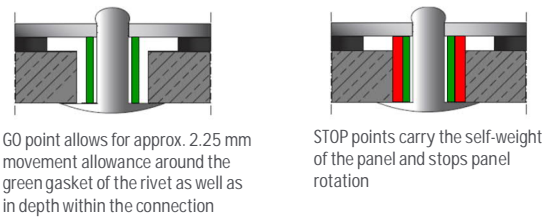

On the intermediate support frame, a narrow strip of the EPDM compressible gasket is applied to one side of the support frame face, away from the panel hole, to allow moisture entering the panel hole to drain down.

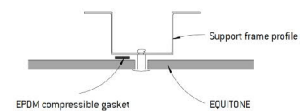

On the support frame located at vertical joints, generally a wider EPDM compressible gasket (40 to 48 mm) is used. This also forms a black expressed joint.

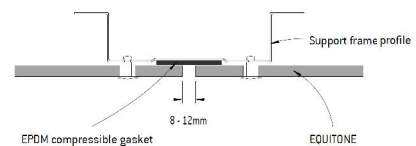

Where two intermediate support frame profiles are located at vertical joint and a coloured metal strip is used to form the expressed joint, two narrow strips of EPDM compressible gasket may be used in lieu of a wider one.

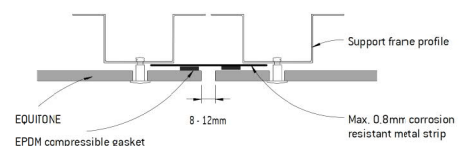

Location of STOP points

The location of STOP points is critical in ensuring a successful façade.

The general principles are:

- Only two STOP points per panel; the rest are GO points
- STOP points are fixed on adjacent supporting frame; never place the 2 STOP points on same support frame profile
- STOP points are located as close as possible to the horizontal centreline of the panel
- STOP points of a panel should be located at the same level; do not position the STOP points diagonally
- Where possible, position the STOP points away from the panel edge
- Where there are more than three lines of fixings position the STOP points symmetrically in relation to the vertical centreline of the panel to balance it

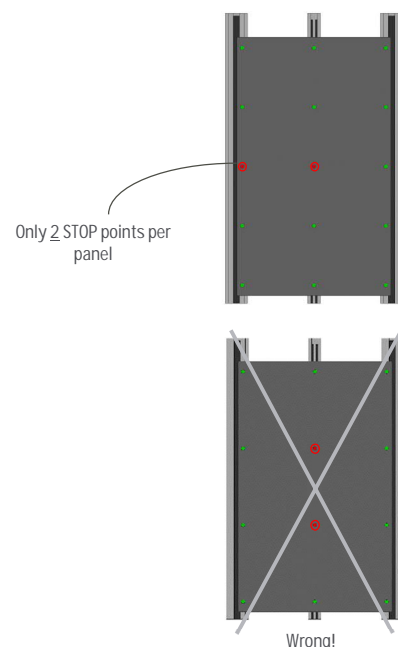

Panel installation



Typical examples of the recommended location of STOP points:

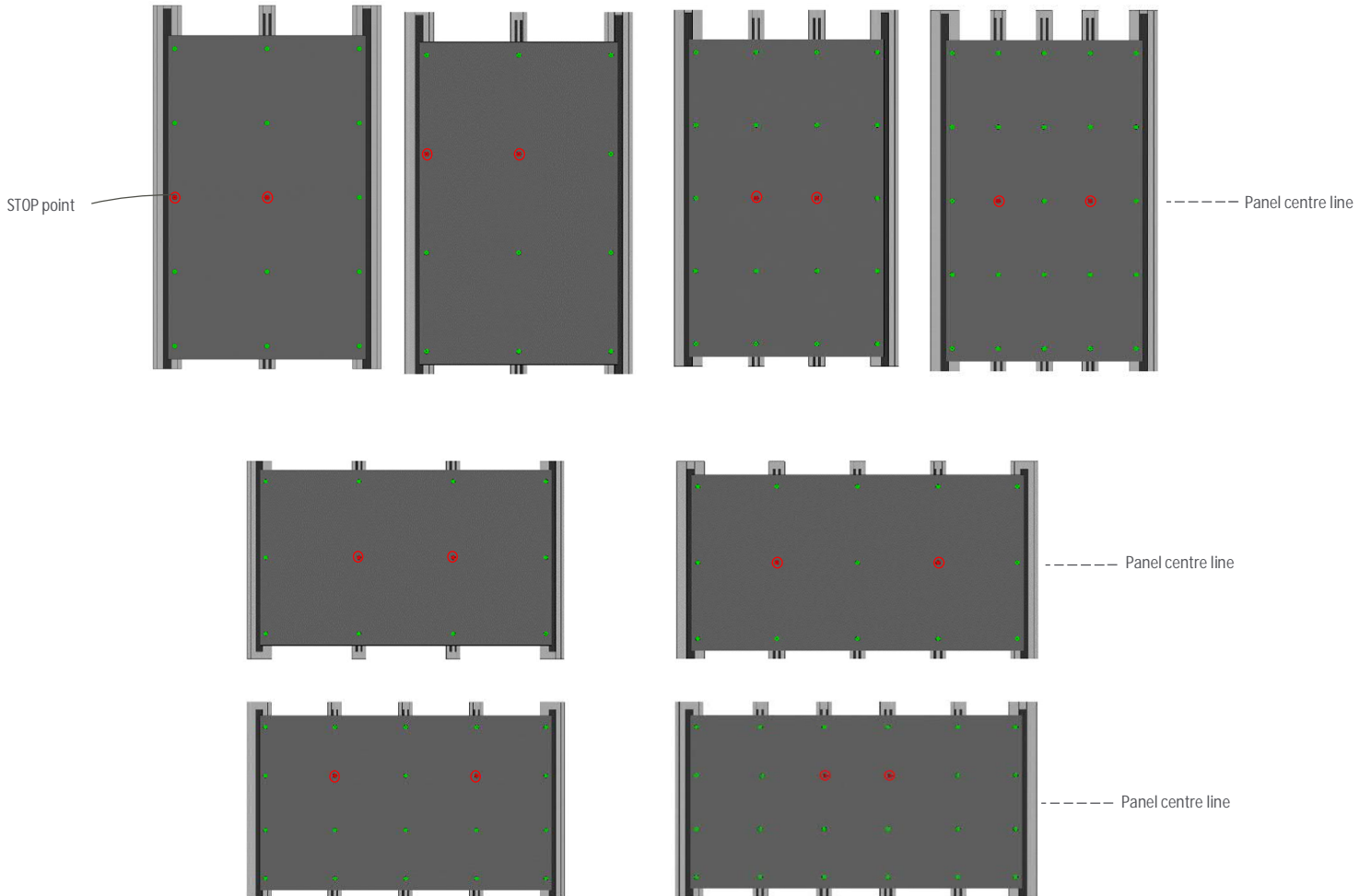

At no time should STOP points be located on the same support frame profile.

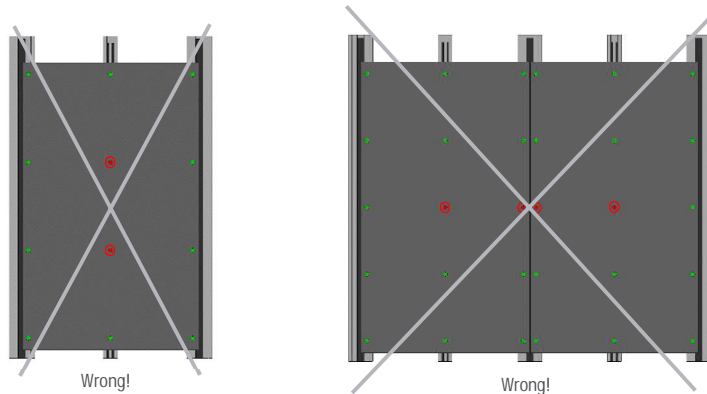

Panel installation

Narrow panels

When narrow EQUITONE panels are used with only two vertical lines of fixings, it is important that there is a vertical break in the supporting frame, so the panels are not locked together. This means using two separate profiles at joints. Depending on the panel arrangement and site conditions this could mean a separation at every joint or a separation at maximum every 3.0m centres.

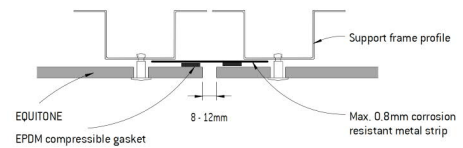
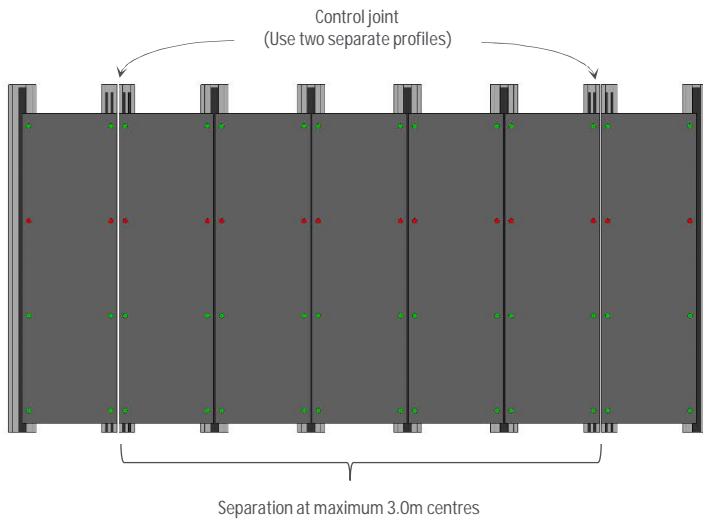

Control joint every 3 m where there are narrow panels with STOP points located on common profiles (the metal strip to be fixed ONLY to one support frame profile, either left or right)

Centralising tool application

EQUITONE centralising tool is used to centre the 4.1 mm rivet hole within the 11 mm panel hole.

The centralising tool must be held perpendicular to the panel face during the application.



After drilling, ensure to remove any metal swarf or debris from the panel hole as otherwise these may rust and cause panel staining.

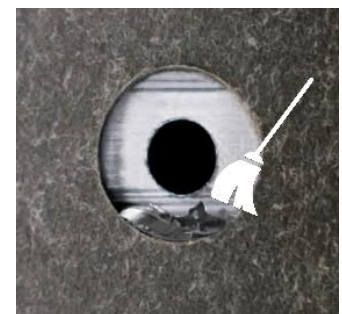

Panel installation

Rivet fixing operation

Always ensure using EQUITONE rivet setting tool. This accessory helps prevent scratching rivet head and panel during fixing operation, and it ensures the correct placement of rivet perpendicular to the support frame and panel.

Rivet gun must be held perpendicular to panel face.



Incorrect application of rivet, oversized rivet hole in the support frame, and/or inadequate thickness of support frame may cause the mandrel of the rivet to break and not be completely pulled out of the rivet, which may result in partial engagement of the rivet with the support frame.





At no time should EQUITONE panel be fixed with screw to metal support frame. Screw fixing of the panel is not allowed at any stage of panel installation.



Panel installation

Panel fixing procedure

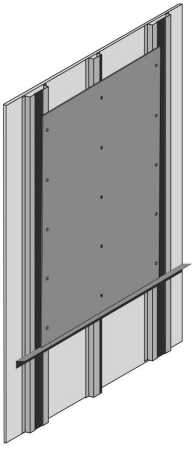
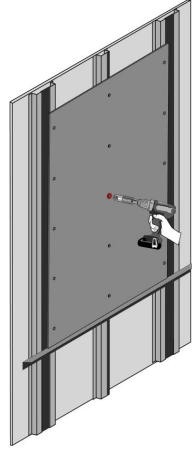
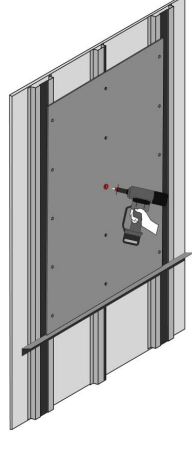
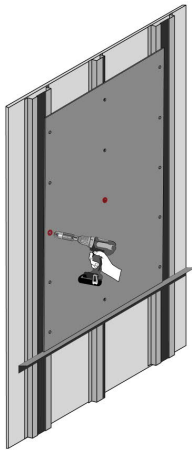
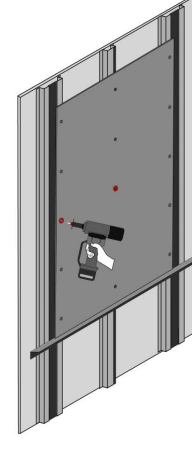
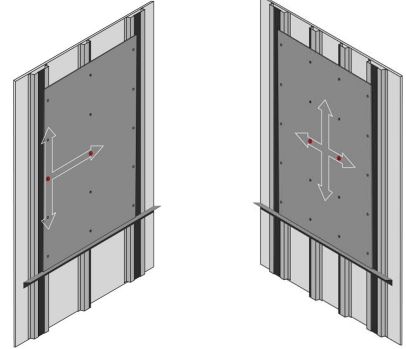
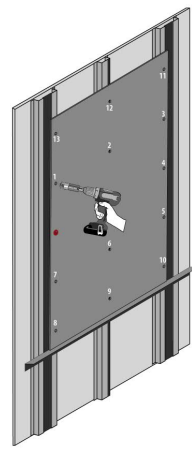
Following the below panel fixing procedure is very important for a successful installation.

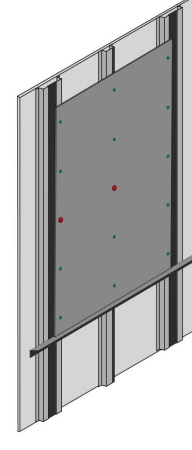
<p>1</p>  <p>Place a pre-drilled panel on the façade.</p> <p>Do not drill the panel holes when the panel is placed in position on the façade.</p> <p>Generally, panel is placed on a temporary support angle, or packers as appropriate.</p> <p>Ensure the EPDM compressible gasket is applied on all the support frame profiles before placing the panel in position.</p>	<p>2</p>  <p>Determine the correct location of the two STOP points in the panel.</p> <p>Using EQUITONE centralising tool, ONLY drill the rivet hole of the STOP point located close to the middle of the panel.</p> <p>Do not yet drill the second STOP point rivet hole.</p> <p>Clean the panel hole from any metal swarf.</p> <p>Ensure holding the drill perpendicular to panel.</p>	<p>3</p>  <p>It is now the time to apply the first STOP point rivet.</p> <p>Remove all metal swarf from the panel hole before applying the rivet.</p> <p>Always ensure that rivet gun is held perpendicular to panel face.</p>
<p>4</p>  <p>Now using EQUITONE centralising tool, drill the rivet hole for the second STOP point.</p> <p>Do not drill the other rivet holes yet.</p> <p>Clean the panel hole from any metal swarf.</p> <p>Ensure holding the drill perpendicular to panel.</p>	<p>5</p>  <p>Apply the second STOP point rivet.</p> <p>Remove all metal swarf from the panel hole before applying the rivet.</p>	<p>Note</p>  <p>After applying the STOP rivets, the GO point rivet holes can now be drilled using EQUITONE centralising tool. For this, always start with the holes located close to the centre of the panel and move outwards towards the panel edges; the very top and bottom holes are to be drilled last. This ensures panel is installed flat and stress free.</p>
<p>6</p>  <p>Once the STOP point rivets are in place, the GO point rivet holes can be drilled using EQUITONE centralising tool.</p> <p>Always start with the holes located close to the centre of the panel and move outwards towards the panel edges.</p> <p>Ensure holding the drill perpendicular to panel.</p>	<p>7</p>  <p>Apply the GO point rivets. Ensure all rivets sit flat on the panel surface.</p> <p>Remove all metal swarf from the panel holes before applying any rivet.</p> <p>Always ensure that rivet gun is held perpendicular to panel face.</p>	<p>8</p>  <p>Ensure all rivets are in place.</p>

Panel installation

Installation sequence

General notes

A sequence or method of placing the EQUITONE panels on the façade must be put in place to ensure the risk of damage to the panels is minimised.

EQUITONE panels are a finished façade product and are generally the last major cladding material to be fitted. Due care is therefore required.

Care and attention are required if other trades (e.g. painting or rendering) need to follow on after the panel is fitted. The panels must then be protected. Stains from coloured renders cannot be removed, and replacement of the panels is the only remedy.

Corflute sheets or the like are generally used to protect the panels. These sheets are generally temporarily fixed to the support frame located at vertical panel joints. Do not use tape as it may leave residue on and stain the panels when it is removed.

Top-down installation method

Experience has shown that the best sequence in placing the EQUITONE panels using EQUITONE UNI-rivets is to start at the top of the façade and work downwards.

It is important to –

- prevent damage to the panel,
- provide an easy way to adjust the panel,
- provide a safe and secure way to temporarily hold the panel before fixing, and
- prevent the panel slipping down the façade.

This method brings several benefits to the installer:

- using a support rail (angle) ensures accurate joints,
- support rail acts as additional workman,
- reduces risk of panel staining as installer works away from installed panels,
- reduces risk of damaging panel by working on scaffold, and
- reduces the time required to clean the façade.

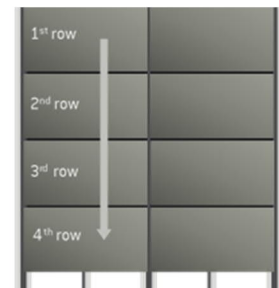

Panel installation

Installation sequence (top-down method)

1

Ensure the support frame has been installed and set out correctly and is straight and plumb.

Apply the EPDM compressible gaskets onto the support frame profiles.

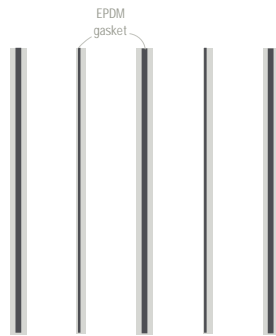

2

Starting at the top of the façade, mark the bottom edge of the top panel on the supporting rails. Align this position-mark across the façade.

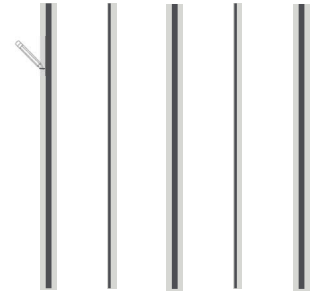

3

Temporarily apply a metal carrier (support angle) across the support frame profiles. This support angle will act as another workman and will carry the weight of the panel and allow easy adjustment prior to fixing. In addition, the support angle will provide a wide ledge to stop the panel sliding down the façade before fixing.



4

Lift the first panel onto this support angle and position into place. Securely hold the panel in position. Using a packer on the support angle will allow ease of minor adjustment. For larger adjustments, the support angle needs re-setting.

Install the panel. Always fix the STOP points first to hold the panel in place, and then radiate outwards towards the edges with the other G0 points.

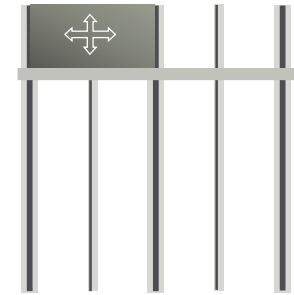

5

Lift and slide the next EQUITONE panel into place. Use spacers (10mm) of a type not to cause damage when being removed, to give a constant vertical joint gap. Fix this panel as the first panel. Continue across the façade, moving the support angle as the work progresses.

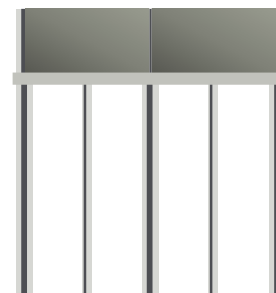

6

Now that the top row is in place remove the support angle.

Fix in place the parapet capping or fix a temporary cover over the top of the façade to prevent water running down the back of the panels. This capping, whether permanent or temporary, must respect the ventilation gap.

Measure down from bottom edge of the upper fixed panel and mark the position of the bottom edge of the next row of panels. This measurement is equivalent to the height of the panel plus the horizontal joint (panel + 10mm). Then fix the temporary support angle in this position.

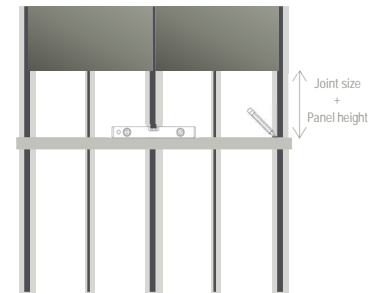

7

For baffled horizontal joint, cut the baffle to approx. 4 mm shorter than the panel width and slide it into place and under the installed panel before installing the next row panel.



8

Then lift the first panel of this row onto the support angle and position it into place lining up the panel vertical edge with the edge above. Repeat the fixing sequence for the panel. Continue working across the façade. The whole procedure is then repeated down the façade of the building.

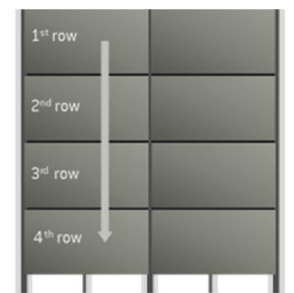

Panel installation

Installing the panels from ground level upwards

For limited applications, sometimes it may be necessary to commence cladding from the base of the facade. This can be done successfully but requires the installer to take extra care and attention to prevent damaging the edge of the panel. The most likely damage will be the top edge of the lower panels. As the weight of the upper panel will be resting on the spacers which in turn will be resting on the lower panel. Therefore, removal of the joint spacers must be done with utmost care.

One suggestion is to use an 8mm spacer and wrap a 1mm rubber strip around the top face, back edge and bottom face of the spacer. Remove the spacer first and then the rubber strip. The rubber strip protects the edges of the panels as the spacer is being removed.

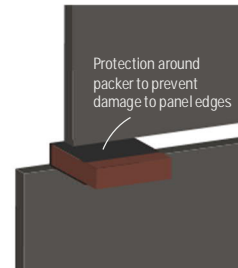

Flashings thickness

Flashings, trims, and the like must be designed in accordance with the relevant standards, regulations, project requirements, and wind loading.

The thickness of any flashings, perforated profiles, and the like placed in between EQUITONE panel and support frame profile must not exceed 0.8 mm.

Coordination with other trades

Proper coordination between the façade contractor installing EQUITONE panels and other trades with works around EQUITONE panels is crucial in ensuring all these trades are fully aware of the allowance for ventilation requirements.

For instance, the installation of capping/flushing over EQUITONE panels sometimes is carried out by a different trade than the façade contractor. In this case, lack of coordination between the two trades may result in the required air outlets for EQUITONE being closed and blocked with an incorrect installation of these elements.

Another example is when the paving and landscaping works block the air inlet of EQUITONE at the bottom of the façade, or where window sills/flashings hinder or block the ventilation at the interface with window heads and sills due to incorrect detailing or installation of these components.

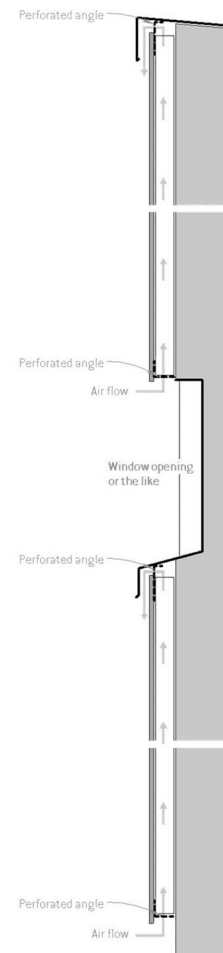

Typical construction details

Refer to 'Construction details – EQUITONE with face fixings on metal support frame' document for a comprehensive set of independently assessed and certified EQUITONE typical construction details which must be read in conjunction with this Design and Installation Guide.

Engineering

EQUITONE

General information

The information provided in this section is based on the information received from an independent consultant who has been engaged to provide their opinion, engineering design and report based on independently conducted laboratory testing, technical data sheets of EQUITONE materials and components, relevant standards, and/or their experience.

It is the responsibility of project consultants and engineers to ensure the provided information in this document is appropriate to the project and intended application. The overall performance of an installed EQUITONE façade or wall assembly is the responsibility of the project designer, architect, engineers and consults, builder and/or certifier. The project wind category and maximum wind pressure applied to the cladding or façade shall be determined by the project engineer. Maximum deflection of support frame must be limited to Span/250.

EQUITONE span tables

Table 1 – Maximum panel fixings spacing – Class 1 & 10 buildings – General zone

AS 4055 wind category	General zone	
	Maximum horizontal spacing (X) of panel fixings (mm)	Maximum vertical spacing (Y) of panel fixings (mm)
N1	600	600
N2	600	600
N3/C1	600	600
N4/C2	600	600
N5/C3	600	450
N6/C4	500	400

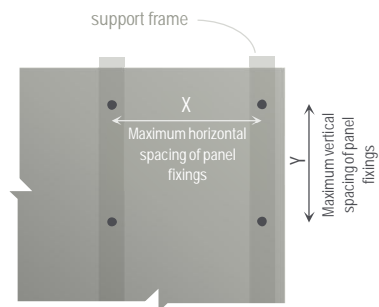

Table 2 – Maximum panel fixings spacing – Class 1 & 10 buildings – Corner zone

AS 4055 wind category	Corner zone	
	Maximum horizontal spacing (X) of panel fixings (mm)	Maximum vertical spacing (Y) of panel fixings (mm)
N1	600	600
N2	600	600
N3/C1	600	500
N4/C2	500	400
N5/C3	400	300
N6/C4	300	300

Maximum spacing of panel fixings/support frame:

- For wall applications: 600 mm or less depending on wind loading (see the span tables)
- For soffit/ceiling applications: 400 mm or less depending on wind loading (see the span tables)

The above limits apply to both internal and external applications.

Table 3 – Maximum ultimate wind pressure applied to EQUITONE with respect to maximum panel fixings spacing – All building classes

Vertical spacing (Y) of cladding fixings (mm)	Horizontal spacing (X) of cladding fixings (mm)								
	600	550	500	450	400	350	300	250	200
	Max AS/NZS1170.2 ultimate wind pressure (kPa)								
600	1.64	1.79	1.97	2.19	2.37	2.37	2.37	2.37	2.37
550	1.79	1.96	2.15	2.39	2.69	2.82	2.82	2.82	2.82
500	1.97	2.15	2.37	2.63	2.96	3.38	3.41	3.41	3.41
450	2.19	2.39	2.63	2.92	3.29	3.76	4.10	4.21	4.21
400	2.37	2.69	2.96	3.29	3.70	4.23	4.62	4.73	4.77
350	2.37	2.82	3.38	3.76	4.23	4.83	5.28	5.41	5.45
300	2.37	2.82	3.41	4.10	4.62	5.28	6.15	6.31	6.35
250	2.37	2.82	3.41	4.21	4.73	5.41	6.31	7.58	7.62
200	2.37	2.82	3.41	4.21	4.77	5.45	6.35	7.62	9.53

See next page for the notes in relation to the above tables.

Table 4 – Maximum panel fixings spacing with respect to maximum ultimate wind pressure applied to EQUITONE – All building classes

Ultimate wind pressure (kPa)	Maximum horizontal spacing (X) of panel fixings (mm)	Maximum vertical spacing (Y) of panel fixings (mm)
1.00	600	600
1.25	600	600
1.50	600	600
1.75	600	550
2.00	600	450
2.25	600	400
2.50	550	400
2.75	550	350
3.00	500	350
3.50	450	350
4.00	450	300
5.00	350	300
6.00	300	300
7.00	250	250

Notes for Table 1, 2, 3, and 4

- Wind loads have been determined for external pressures only; it is assumed that internal pressures are resisted by appropriately designed internal linings.
- Wind loads have been determined in accordance with AS/NZS 1170.2.
- General zone: Areas greater than 1200 mm from an external building corner. Corner zone: Areas less than 1200 mm from an external building corner.
- Maximum panel cantilever must not exceed 150 mm.
- Support frame is to be either minimum 1.1 mm BMT G250 steel, or minimum 2 mm BMT 6005A T5 aluminium.
- Framing deflection is limited to Span/250 with the serviceability wind load equal to 68% of the ULS wind load.
- The values apply to both non-cyclonic and cyclonic wind regions as well as both multiple (panel fixed to three or more battens) and single span (panel fixed only to two battens) cladding.
- Spacings are based on centre to centre distance of the panel fixings.



The design of cladding support frame is the responsibility of the project façade or structural engineer.

The connection of the support frame to substructure should be designed by the project façade or structural engineer.

Support frame

General information

This section serves only as a general guide providing information in relation to the design of the cladding support frame, and is provided based on an engineering report received from an independent consultant. It is the responsibility of the project designer or engineer to ensure the provided information in this section is correct and appropriate to their intended application. Maximum deflection of support frame must be limited to Span/250.

EQUITONE may be installed onto engineered metal support frame fixed to an appropriately designed substructure which could be a timber or metal stud frame (or the like), masonry, or concrete. Both support frame and substructure should be designed in accordance with the Building Code of Australia and applicable standards including but not limited to the following:

- AS 1684 – Residential timber-framed buildings
- AS/NZS 4600 – Cold-formed steel structures

Single layer top hat construction span tables

In this section, general guidance has been provided on the span of typical top hat support frame profiles fixed to timber/metal framed substructure. The fixings of the support frame to substructure should be determined by the project engineer. This framing arrangement is used where the substructure is engineered to directly support vertical top hat profiles (cladding support frame).

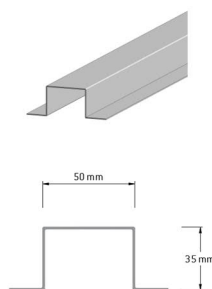
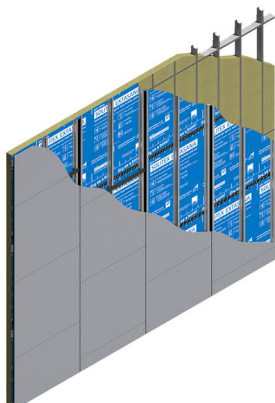

Typical intermediate top hat profile

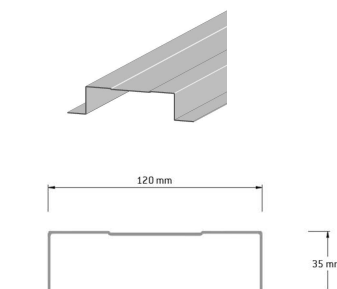

Typical joint top hat profile located at panel vertical joints

Engineering

Table 5 – Maximum span of vertical top hat – Class 1 & 10 buildings
General zone

AS 4055 wind category	Vertical top hat spacing (X)						
	600	550	500	450	400	350	300
	Max. top hat span when fixed to 0.55BMT G550 steel stud frame (mm)						
N1	1200	1200	1200	1200	1200	1200	1200
N2	1200	1200	1200	1200	1200	1200	1200
N3/C1	1200	1200	1200	1200	1200	1200	1200
N4/C2	1050	1100	1200	1200	1200	1200	1200
N5/C3	750	800	900	1000	1100	1150	1200
N6/C4	550	600	650	750	850	950	1100
	Max. top hat span when fixed to timber stud frame, or 0.75BMT G550 or 1.15BMT G2 steel stud frame (mm)						
N1	1200	1200	1200	1200	1200	1200	1200
N2	1200	1200	1200	1200	1200	1200	1200
N3/C1	1200	1200	1200	1200	1200	1200	1200
N4/C2	1050	1100	1200	1200	1200	1200	1200
N5/C3	900	900	950	1000	1100	1150	1200
N6/C4	700	750	800	850	950	1000	1100

Table 6 – Maximum span of vertical top hat – Class 1 & 10 buildings
Corner zone

AS 4055 wind category	Vertical top hat spacing (X)						
	600	550	500	450	400	350	300
	Max. top hat span when fixed to 0.55BMT G550 steel stud frame (mm)						
N1	1200	1200	1200	1200	1200	1200	1200
N2	1200	1200	1200	1200	1200	1200	1200
N3/C1	800	900	1000	1100	1200	1200	1200
N4/C2	550	600	650	750	850	950	1100
N5/C3	350	400	450	500	550	650	750
N6/C4	250	300	300	350	400	450	550
	Max. top hat span when fixed to timber stud frame, or 0.75BMT G550 or 1.15BMT G2 steel stud frame (mm)						
N1	1200	1200	1200	1200	1200	1200	1200
N2	1200	1200	1200	1200	1200	1200	1200
N3/C1	950	1000	1050	1100	1200	1200	1200
N4/C2	700	750	800	900	950	1050	1100
N5/C3	450	500	550	600	700	800	900
N6/C4	350	350	400	450	500	600	700

Table 7 – Maximum span of vertical top hat – All building classes

Ultimate wind pressure (kPa)	Vertical top hat spacing (X)						
	600	550	500	450	400	350	300
	Max. top hat span when fixed to 0.55BMT G550 steel stud frame (mm)						
1.00	1200	1200	1200	1200	1200	1200	1200
1.25	1200	1200	1200	1200	1200	1200	1200
1.50	1100	1150	1200	1200	1200	1200	1200
1.75	900	1000	1100	1150	1200	1200	1200
2.00	800	900	950	1100	1150	1200	1200
2.25	700	800	850	950	1100	1150	1200
2.50	650	700	750	850	950	1100	1200
2.75	600	650	700	800	900	1000	1150
3.00	550	600	650	700	800	900	1100
3.50	450	500	550	600	700	800	900
4.00	400	450	450	550	600	700	800
5.00	300	350	350	400	450	550	650
6.00	250	300	300	350	400	450	550
7.00	200	250	250	300	350	400	450
	Max. top hat span when fixed to 0.75BMT G550, or 1.15BMT G2 steel stud frame (mm)						
1.00	1200	1200	1200	1200	1200	1200	1200
1.25	1200	1200	1200	1200	1200	1200	1200
1.50	1100	1150	1200	1200	1200	1200	1200
1.75	1000	1050	1100	1150	1200	1200	1200
2.00	950	1000	1050	1100	1150	1200	1200
2.25	900	950	1000	1050	1100	1150	1200
2.50	850	900	950	1000	1050	1100	1200
2.75	800	850	900	950	1000	1050	1150
3.00	750	800	850	900	950	1000	1100
3.50	650	700	800	800	850	950	1000
4.00	550	600	700	750	800	850	950
5.00	450	500	550	600	700	800	850
6.00	350	400	450	500	550	650	750
7.00	300	350	400	450	500	550	650

Notes for Table 5, 6, and 7

- Before using these tables, refer to EQUITONE span tables to determine the vertical top hat spacing.
- Wind loads have been determined for external pressures only; it is assumed that internal pressures are resisted by appropriately designed internal linings.
- Wind loads have been determined in accordance with AS/NZS 1170.2.
- General zone: Areas greater than 1200 mm from an external building corner. Corner zone: Areas less than 1200 mm from an external building corner.
- Maximum top hat cantilever to be limited to 20% of the adjacent span.
- Span tables are based on typical 1.1 mm BMT 35x50 mm and 35x120 mm G250 top hats.
- Framing deflection is limited to Span/250 with the serviceability wind load equal to 68% of the ULS wind load.
- All spans have been limited to 1250 mm.
- The values are based on the fixings of the top hat to stud frame being minimum two 12g-14TPI self-drilling Hex Head Tek screws. The fixings of the cladding framing (top hats) have not been tested and evaluated for cyclonic regions.
- The fixings of the cladding framing must be confirmed by project engineer.

Double layer top hat construction span tables

This is the most common support frame arrangement, particularly where the substructure cannot directly support the cladding vertical support frame. In this case, generally, a layer of horizontal top hats (min. 15 mm deep) is first applied and fixed to the substructure, followed by vertical top hats to which panels are fixed.

In this section, general guidance has been provided on the spacing of the horizontal top hats fixed to engineered timber/metal framed substructure. The fixings of the support frame to the substructure should be determined by the project engineer. The span of vertical 35 mm top hats may be obtained from the previous section.

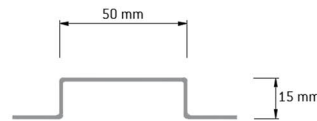
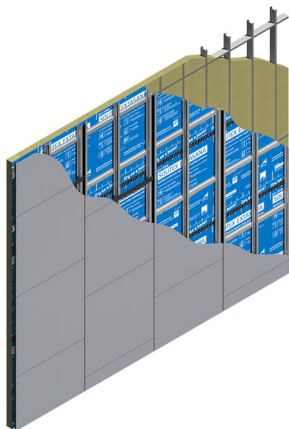

Typical horizontal top hat profile

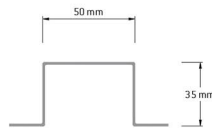

Typical intermediate top hat profile

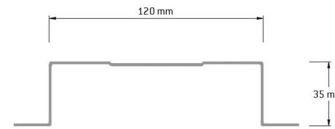

Typical joint top hat profile located at panel vertical joints

Table 8 – Maximum spacing of horizontal 15 mm top hats – Class 1 & 10 buildings
General zone

AS 4055 wind category	Stud spacing (mm)	Vertical top hat spacing (X)						
		600	550	500	450	400	350	300
		Max. spacing of horizontal top hats fixed to 0.55BMT G550 steel stud frame (mm)						
N1	600	1200	1200	1200	1200	1200	1200	1200
	450	1200	1200	1200	1200	1200	1200	1200
N2	600	1050	1050	1050	1050	1050	1050	1050
	450	1050	1200	1200	1200	1200	1200	1200
N3/C1	600	650	650	650	650	650	650	650
	450	650	800	950	1200	1200	1200	1200
N4/C2	600	450	450	450	450	450	450	450
	450	450	550	650	800	800	800	800
N5/C3	600	300	300	300	300	300	300	300
	450	300	350	450	550	550	550	550
N6/C4	600	200	200	200	200	200	200	200
	450	200	250	300	400	400	400	400
		Max. spacing of horizontal top hats fixed to timber stud frame, or 0.75BMT G550 or 1.15BMT G2 steel stud frame (mm)						
N1	600	1200	1200	1200	1200	1200	1200	1200
	450	1200	1200	1200	1200	1200	1200	1200
N2	600	1050	1050	1050	1050	1050	1050	1050
	450	1050	1200	1200	1200	1200	1200	1200
N3/C1	600	650	650	650	650	650	650	650
	450	650	800	950	1200	1200	1200	1200
N4/C2	600	450	450	450	450	450	450	450
	450	450	550	650	800	800	800	800
N5/C3	600	300	300	300	300	300	300	300
	450	300	350	450	550	550	550	550
N6/C4	600	200	200	200	200	200	200	200
	450	200	250	300	400	400	400	400

Engineering

Table 9 – Maximum spacing of horizontal 15 mm top hats – Class 1 & 10 buildings
Corner zone

AS 4055 wind category	Stud spacing (mm)	Vertical top hat spacing (X)						
		600	550	500	450	400	350	300
Max. spacing of horizontal top hats fixed to 0.55BMT G550 steel stud frame (mm)								
N1	600	800	800	800	800	800	800	800
	450	800	950	1150	1200	1200	1200	1200
N2	600	550	550	550	550	550	550	550
	450	550	650	800	1000	1000	1000	1000
N3/C1	600	350	350	350	350	350	350	350
	450	350	400	500	650	650	650	650
N4/C2	600	200	200	200	200	200	200	200
	450	200	250	350	400	400	400	400
N5/C3	600	150	150	150	150	150	150	150
	450	150	200	200	300	300	300	300
N6/C4	600	100	100	100	100	100	100	100
	450	100	100	150	200	200	200	200
Max. spacing of horizontal top hats fixed to timber stud frame, or 0.75BMT G550 or 1.15BMT G2 steel stud frame (mm)								
N1	600	800	800	800	800	800	800	800
	450	800	950	1150	1200	1200	1200	1200
N2	600	550	550	550	550	550	550	550
	450	550	650	800	1000	1000	1000	1000
N3/C1	600	350	350	350	350	350	350	350
	450	350	400	500	650	650	650	650
N4/C2	600	200	200	200	200	200	200	200
	450	200	250	350	400	400	400	400
N5/C3	600	150	150	150	150	150	150	150
	450	150	200	200	300	300	300	300
N6/C4	600	100	100	100	100	100	100	100
	450	100	100	150	200	200	200	200

Notes for Table 8 & 9

- Before using these tables, refer to EQUITONE span tables to determine the vertical top hat spacing.
- Wind loads have been determined for external pressures only; it is assumed that internal pressures are resisted by appropriately designed internal linings.
- Wind loads have been determined in accordance with AS/NZS 1170.2.
- General zone: Areas greater than 1200 mm from an external building corner. Corner zone: Areas less than 1200 mm from an external building corner.
- Maximum top hat cantilever to be limited to 20% of the adjacent span.
- Span tables are based on typical horizontal 1.1 mm BMT 15x50mm G250, and vertical 1.1mm BMT 35x50/120mm G250 top hats.
- Framing deflection is limited to Span/250 with the serviceability wind load equal to 68% of the ULS wind load.
- All spans have been limited to 1250 mm.
- The values are based on the fixings of both the vertical top hat to horizontal top hat and the horizontal top hat to stud being minimum two T2g-14TPI self-drilling Hex Head Tek screws. The fixings of the cladding framing have not been tested and evaluated for cyclonic regions.
- The fixings of the cladding framing must be confirmed by project engineer.
- Ensure the fixings of the vertical top hats to horizontal ones do not damage the weather barrier.

Table 10 – Maximum spacing of horizontal 15 mm top hats – All building classes

Ultimate wind pressure (kPa)	Stud spacing (mm)	Vertical top hat spacing (X)													
		600	550	500	450	400	350	300	600	550	500	450	400	350	300
		Max. spacing of horizontal top hats fixed to 0.55BMT G550 steel stud frame (mm)							Max. spacing of horizontal top hats fixed to 0.75BMT G550, or 1.15BMT G2 steel stud frame (mm)						
1.00	600	700	700	700	700	700	700	700	700	700	700	700	700	700	700
	450	700	850	1000	1200	1200	1200	1200	700	850	1000	1200	1200	1200	1200
1.25	600	550	550	550	550	550	550	550	550	550	550	550	550	550	550
	450	550	650	800	1000	1000	1000	1000	550	650	800	1000	1000	1000	1000
1.50	600	450	450	450	450	450	450	450	450	450	450	450	450	450	450
	450	450	550	650	850	850	850	850	450	550	650	850	850	850	850
1.75	600	400	400	400	400	400	400	400	400	400	400	400	400	400	400
	450	400	450	550	700	700	700	700	400	450	550	700	700	700	700
2.00	600	350	350	350	350	350	350	350	350	350	350	350	350	350	350
	450	350	400	500	600	600	600	600	350	400	500	600	600	600	600
2.25	600	300	300	300	300	300	300	300	300	300	300	300	300	300	300
	450	300	350	450	550	550	550	550	300	350	450	550	550	550	550
2.50	600	250	250	250	250	250	250	250	250	250	250	250	250	250	250
	450	250	300	400	500	500	500	500	250	300	400	500	500	500	500
2.75	600	250	250	250	250	250	250	250	250	250	250	250	250	250	250
	450	250	300	350	450	450	450	450	250	300	350	450	450	450	450
3.00	600	200	200	200	200	200	200	200	200	200	200	200	200	200	200
	450	200	250	300	400	400	400	400	200	250	300	400	400	400	400
3.50	600	200	200	200	200	200	200	200	200	200	200	200	200	200	200
	450	200	200	250	350	350	350	350	200	200	250	350	350	350	350
4.00	600	150	150	150	150	150	150	150	150	150	150	150	150	150	150
	450	150	200	250	300	300	300	300	150	200	250	300	300	300	300
5.00	600	100	100	100	100	100	100	100	100	100	100	100	100	100	100
	450	100	150	200	250	250	250	250	100	150	200	250	250	250	250
6.00	600	100	100	100	100	100	100	100	100	100	100	100	100	100	100
	450	100	100	150	200	200	200	200	100	100	150	200	200	200	200
7.00	600	100	100	100	100	100	100	100	100	100	100	100	100	100	100
	450	100	100	100	150	150	150	150	100	100	100	150	150	150	150

Notes for Table 10

- Before using these tables, refer to EQUITONE span tables to determine the vertical top hat spacing.
- The length of the fixings used for fixing the vertical top hats to horizontal top hats shall be selected such that the fixings do not penetrate and damage the weather barrier.
- Wind loads have been determined for external pressures only; it is assumed that internal pressures are resisted by appropriately designed internal linings.
- Wind loads have been determined in accordance with AS/NZS 1170.2.
- General zone: Areas greater than 1200 mm from an external building corner.
- Corner zone: Areas less than 1200 mm from an external building corner.
- Maximum top hat cantilever to be limited to 20% of the adjacent span.
- Span tables are based on typical horizontal 1.1 mm BMT 15x50mm G250, and vertical 1.1mm BMT 35x50/120mm G250 top hats.
- Framing deflection is limited to Span/250 with the serviceability wind load equal to 68% of the ULS wind load.
- All spans have been limited to 1250 mm.
- The values are based on the fixings of both the vertical top hat to horizontal top hat and the horizontal top hat to stud being minimum two 12g-14TPI self-drilling Hex Head Tek screws. The fixings of the cladding framing have not been tested and evaluated for cyclonic regions.
- The fixings of the cladding framing must be confirmed by project engineer.
- Ensure the fixings of the vertical top hats to horizontal ones do not damage the weather barrier.

Engineering



For further information about NVELOPE components and product specifications, refer to the supplier of NVELOPE systems.

The application of NVELOPE systems shall be in accordance with its supplier's recommendations and guidelines.

Aluminium bracketry framing system

This type of support frame generally comprises vertical rails, to which cladding is fixed, and brackets connecting the vertical rails to the substructure. NVELOPE offers a range of aluminium bracketry systems commonly used with EQUITONE.

Refer to the supplier of NVELOPE support frames for general guidance and span tables for typical applications.



Support frame thermal movement

Allowance for any expansion and contraction of the metal supporting frame needs to be considered in the overall design of the system. Adequate allowance for the thermal movement of the support frame needs to be made, particularly, at its connection to the substrate.

Where an aluminium bracketry system is used, the brackets usually include both round (fixed) and elongated (gliding) holes for the purpose of allowance for thermal movement of the vertical rail.

Where the fixings are applied to the round holes it forms a fixed connection (fixed points) while applying the fixings only to the elongated holes forms the gliding connections (gliding points) allowing for movement. Ensure that the connection between the brackets and the rails provides enough expansion and contraction. The fixings must be centred in the slot.



The fixed-point bracket shall be located at the mid height of the vertical rail. The other brackets need to be gliding points to allow for movement. All fixed points must be at same level around the façade.

The principle of fixing and gliding points is a good one and where possible is recommended for all metal supporting frames. This is particularly relevant in ecologies that experience climatic extremes and large variations in temperature.

Support frame length & joints

It is recommended to limit the length of the vertical rail to 3.1m (maximum panel height).

A minimum gap of 20 mm shall be considered between two vertical support frame profiles.

EQUITONE panel must not bridge this gap or any control/movement joints while fixed to both adjacent profiles.

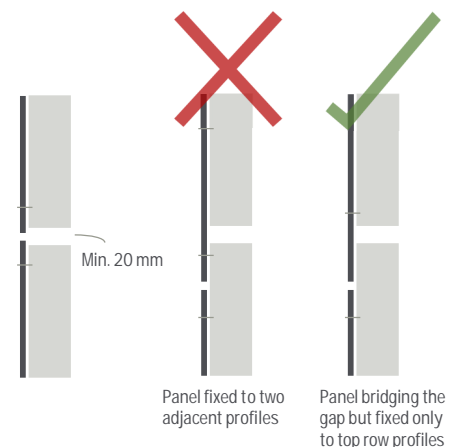

Design considerations

Application

EQUITONE may be used internally or externally on all types of buildings provided that the façade is designed according to applicable loads including project wind loading, project location, general guidelines provided in this document, applicable standards and regulations, and the Building Code of Australia.

For any project specific design and/or applications outside of the typical applications covered in this and other EQUITONE technical documents, seek further advice from your local EQUITONE technical team.

Limitations

There are limitations for use of EQUITONE panels on non-vertical external applications. Refer to Etex Exteriors ANZ technical department for more information and project specific advice.

EQUITONE has been designed for ventilated façade systems. For non-ventilated external applications like encased curtain wall type, refer to Etex Exteriors ANZ technical department for limitations and recommendations.

EQUITONE is not recommended for the following applications:

- Internal applications exposed to direct moisture e.g. wet areas
- Contact with standing snow or ice
- Exposure to temperatures exceeding 80°C

Façade layout

While the design of the supporting frame is calculated around the wind loading, the facade will be subjected to the actual panel layout desired by the Architect. The panel layout can have a significant influence on the amount of large or small profiles needed.

For example, using the same size panel in a vertical pattern will result in a different supporting frame layout than if the panels were arranged horizontally. The vertical panel arrangement will use approximately a 50/50 split of large and small profiles while the same panel used with a horizontal arrangement will use only half as many large profiles and more small profiles. Therefore, reducing the cost of the support framing.

Other influences on the supporting frame layout include having staggered panel joints or total free patterns requiring different size panels in a random layout. This could result in having to use all large profiles.

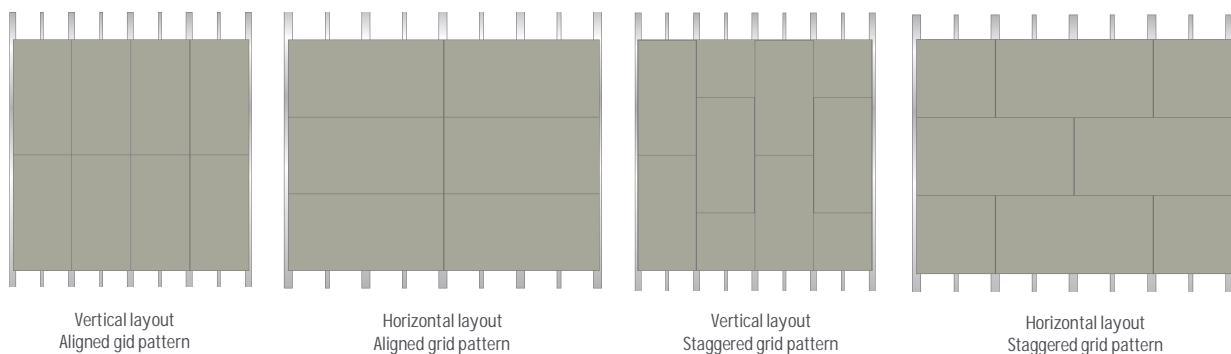

Regardless of the type of the panel layout, it is important to have a break in both the cladding and support frame at any control or movement joints, e.g. generally under the slabs or where there is a deflection, movement, or control joint. See 'Movement & control joints' section.

Design considerations

Economic panel size

EQUITONE panels can be cut to any size and offer the architect and designer wide design freedom. When designing, the following information is aimed at providing the specifier with guidance on the most economic material usage from standard sheets. Sizes greater than half the maximum manufacturing lengths become progressively less economical in ratio to the distance downwards from full length to half length as indicated on the following charts.

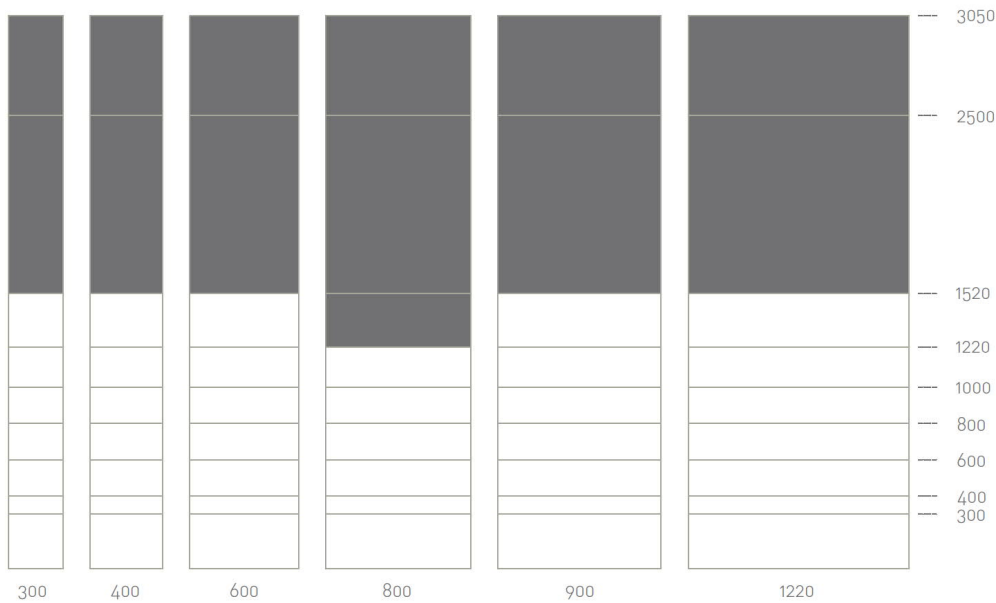

The shaded areas indicate the most uneconomic modules cut from a standard sheet size (based on 1220mm x 3050mm sheet).

Movement & control joints

Cladding and its support framing must not bridge over a building movement or control joint while fixed to both sides of the joint. Adequate separation in both cladding and its support framing is required at any movement or control joint and the like.

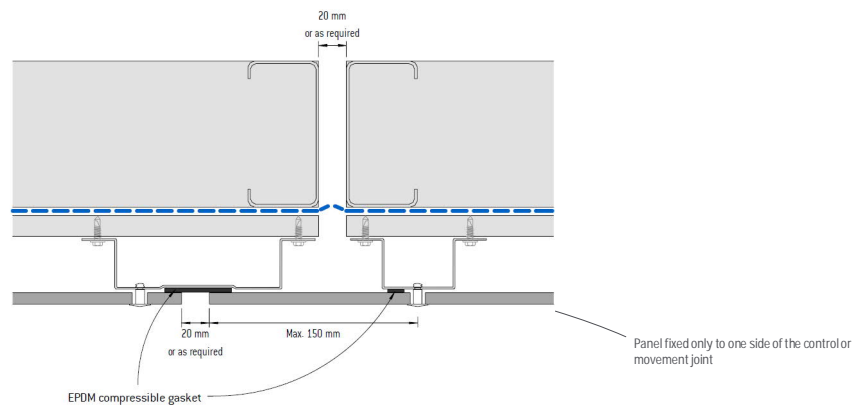

Design considerations

Generally, at the slab levels where differential movement of the slab and/or frame shrinkage may be a concern, a horizontal control joint is considered and an inter storey flashing is incorporated as required.

The support frame must not bridge the movement or deflection joint while fixed to substructure or framing located above and below the movement or deflection joint unless allowance for the required movement is made e.g. through a bracketry system with elongated holes in its brackets or connection with the substructure or framing.

The inter storey flashing also assists with effective moisture management of the façade by compartmentalisation of the cavity by floor level. The following image shows an example of horizontal control joint or inter storey detail. For full construction details in relation to both general horizontal and vertical control joints interfaces, refer to 'Construction details – EQUITONE with face fixings on metal support frame'.

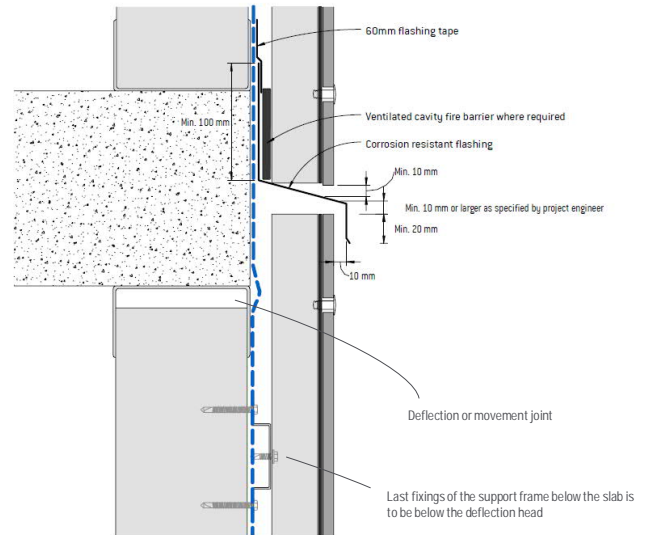

Cavity

The cavity is a primary feature of a ventilated facade. It is designed to act as a pressure cushion to prevent water from reaching the backing wall. By ventilating the cavity, moisture that arises from water passing the panel, moisture migrating from the inner surface of the wall or the action of condensation will be removed either by evaporation, or simply running down the back of the panel and drain out of the cavity.

Cavity width

It is generally considered that the minimum cavity width should be at least 20 mm immediately behind the back of the panel. However, this is only suitable for a cladding height of up to 3 m and low rise buildings with open joints. As the facade gets higher, the cavity needs to increase in width. The general recommended minimum cavity width is 30 mm.

The type of joint used between the panels will also have an influence on the cavity width. Open horizontal joints will allow more air movement than baffled joints and therefore a wider cavity is considered with baffled joints.

Generally, the recommended cavity width with closed (baffled) joints is as below:

EQUITONE cladding height or distance between air inlet and outlet (m)	< 10	< 20	< 50	< 75	< 100	< 125
Minimum cavity width (mm)	30	40	50	60	75	100

NOTE: On renovation projects, when designing the width of the cavity, it is important to make allowance for tolerance. Building irregularities, especially uneven backing walls, external insulation, and/or weather barrier, must never compromise the effective width of the cavity required for a clear air flow behind the panels. This is critical when a horizontal support frame is incorporated into the cavity space. Please note that the minimum cavity width which has been adopted for the purpose of weather proofing assessment and testing of EQUITONE façade systems is 35 mm.

Curved facade

EQUITONE panels are flat. However, it is possible to ease them around a curved facade. Note that the orientation of the panel is also critical. A horizontal panel bends easier than one placed vertically. The minimum radius that an 8mm EQUITONE panel can be fixed to a curved facade is 12 m.

Design considerations

When the panels are applied on a curved façade, the joint will not be square but is angled to accommodate the curve. Visually it is better to keep the outer edge of the joint gap at 10mm and allow the inner edge to be less than 10mm. If not, depending on the curve, the joint could be more than 12mm wide. To allow this to happen it is important that the setting out of the support frame reflects this. The opposite applies to an inner curving façade.

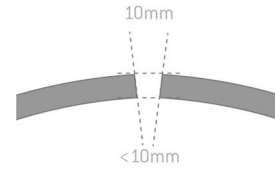

For smaller radiuses, the panel may be segmented into a series of narrow strips. Generally, two intermediate top hats are used in lieu of a wide joint top hat at vertical joints to prevent overstressing of the panel. The following is a typical vertical joint detail. For more details, refer to 'Construction details – EQUITONE with face fixings on metal frame' document.

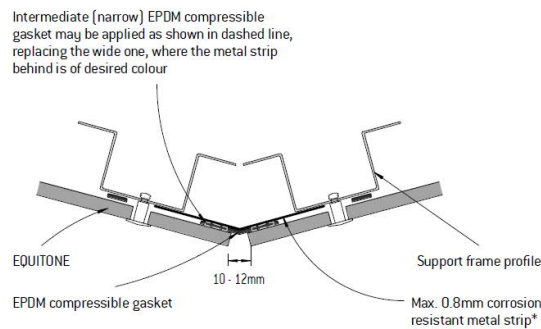

Weatherproofing

System compliance

EQUITONE façade systems have been assessed for the purpose of compliance with the NCC 2022 F3P1 and H2P2 for the following scope:

With flexible weather barrier (sarking):

- Serviceability wind pressure: $\pm 2\text{KPa}$
- Ultimate wind pressure: $\pm 3\text{KPa}$

With rigid weather barrier:

- Serviceability wind pressure: $\pm 2.5\text{KPa}$
- Ultimate wind pressure: $\pm 4.5\text{KPa}$

The above wind pressures shall be calculated as per AS1170.2. For higher wind pressures, a project specific assessment or design by project (façade) engineer is required to ensure suitability and compliance.

Weather (resistive) barrier

The type of weather barrier plays an important role in the effective moisture and condensation management of an external wall. It is the responsibility of the project (façade) engineer or designer to specify an appropriate type of weather barrier. For projects with serviceability wind pressure of 2 KPa or less and ultimate wind pressure of 3 KPa or less, the recommended pro clima SOLITEX EXTASANA® pliable membrane (wall wrap or sarking) may be used. Projects with higher wind pressures generally require a rigid air barrier.



For information about technical properties and correct application of pro clima products refer to pro clima technical documents, and SOLITEX EXTASANA® Application and Fixing Guides.

For information regarding Siniat Weather Defence® and its applications refer to Siniat Weather Defence Technical Manual.

Design considerations

EQUITONE has been independently tested and assessed with pro clima SOLITEX EXTASANA® pliable membrane for the purpose of compliance with the NCC 2022 F3P1 and H2P2. Where a rigid air barrier is required Siniat Weather Defence® may be used. Siniat Weather Defence® also increases the acoustic and fire performance of the façade.

Weather barrier shall be installed in accordance with its manufacturer's recommendations, applicable standards and regulations.

Both pro clima SOLITEX EXTASANA® and Siniat Weather Defence® have a high level of vapour permeance (classified as Class 4 as per AS/NZS 4200.1). The low vapour resistance (high vapour permeance) assists with condensation management where a breather type (vapour permeable) weather barrier is required. It is recommended that a condensation risk analysis is conducted by project engineer or designer for the appropriate selection of the required weather barrier.

The drained and fully ventilated cavity of EQUITONE façade system does assist further with managing condensation as well as keeping the cavity components and weather barrier dry.

In ensuring an effective moisture management of an external wall, the appropriate selection and application of the required flashing/sill tapes (and the like), sealant and flashings play an important part. Pro clima offers a range of tape, weatherproofing and sealing solutions some of which have been incorporated and recommended as part of EQUITONE systems. Consult with your project (façade) engineer for the selection of the required flashings and sealant suitable for your project and intended application. Generally, silicone sealant tends to perform better than other standard sealant types in terms of movement flexibility and UV stability.

Thermal performance and energy efficiency

It is the responsibility of the project designer or engineer to ensure the building envelop including external walls are designed to meet the thermal and energy efficiency requirements of the project, the NCC and applicable regulations. The required level of thermal and acoustic performance of an external wall may be achieved by the selection of appropriate insulation and limiting of heat loss pathways, thermal bridging. The thermal insulation values of external wall may be determined as per the relevant provisions of the NCC and applicable standards including but not limited to AS/NZS 4859.2 for individual building components.

Reducing thermal bridging is also important in managing energy efficiency and condensation. Depending on the building Class, where substructure and support frame are metal, application of a thermal break with a minimum R-value may be required between the substructure and support frame as per the requirements of the NCC. Consult with your project engineer to determine the need for suitable thermal break to ensure compliance with the NCC.

To ensure energy efficiency with regards to artificial heating and cooling, a building should have an appropriate level of air-tightness, as needed based on its use, internal conditions, and geographical location. The weather barrier including all its penetrations should be adequately sealed to help achieve the required minimum air infiltration rate. Refer to the relevant sections of the NCC for the minimum requirements relevant to your project.

To benefit from all the advantages of a ventilated façade and to significantly reduce or even eliminate thermal bridging, appropriate external insulation may also be used. Refer to Etex Exteriors ANZ technical department for further information on this type of application.

Corrosion zones

EQUITONE panels may be used in all Australia corrosion zones provided that all system components, including support frame, flashings and fixings, are of adequate corrosion resistance appropriate for the project location. Corrosion zones are detailed in AS 4312 and ISO 9223. Based on an independent assessment, EQUITONE and its proprietary flashings, fixings may be used in corrosion zones up to and including C5. In C5 corrosion zone, UNI Rivet with the additional marine and coastal protective coating shall be used.

It is the responsibility of the project designer or engineer to ensure the project is designed in accordance with the NCC requirements for corrosion resistance, and that EQUITONE system is appropriate for the intended application. Ensure all façade components including capping and flashings are designed according to the project wind and corrosion category.



Design considerations

Cyclonic areas

EQUITONE façade has been tested to AS 4040.3 with its proprietary fixings to metal support frame and has been independently evaluated for application in cyclonic areas as per the span tables provided in 'Engineering' section of this document. In some cases, there is a requirement for the building envelope to be designed to withstand the impact of flying (wind-borne) debris in cyclonic areas. In such cases, a metal weather barrier designed and suitable for this purpose may be used. Consult with your project engineer for an appropriate solution.

Fire safety

EQUITONE is fibre cement material and as such is deemed non-combustible in accordance with the following clauses of the NCC, and may be used wherever a non-combustible material is required.

- C2D10(6)(d) of the NCC 2022 Volume 1
- H3D2(1)(d) of the NCC 2022 Volume 2
- C1.9e(iv) of the NCC 2019 Volume 1 (Amendment 1)
- 3.7.1.1(d) of the NCC 2019 Volume 2 (Amendment 1)
- C1.9e(iv) of the NCC 2016 Volume 1 (Amendment 1)
- 3.7.1.2(d) of the NCC 2016 Volume 2

EQUITONE façade materials are classified as a 'Group 1' in accordance with AS 5637.1 and meets Specification C2D11, fire hazard properties, of the NCC 2022 Volume 1, and therefore may be safely used for internal lining and ceiling applications.

Both recommended flexible and rigid weather barrier options meet the fire hazard properties of the NCC. Pro clima SOLITEX EXTASANA® with a flammability index of less than 5 and a thickness of less than 1 mm meets the requirements of the NCC 2022 C2D10(6)(f) & H3D2(1)(f), and Siniat Weather Defence® is compliant with the provisions of the NCC 2022 C2D10(6)(a) & H3D2(1)(a).

In multistorey buildings where fire cavity barriers may be required within the façade cavity, it must be ensured that it does not block drainage and ventilation paths within the cavity. A minimum gap of 20 mm or greater as recommended in the 'Cavity width' section of this document is required between the rear of the cladding and front face of the fire cavity barriers. To achieve this, a fire cavity barrier suitable for ventilated façade, which are usually intumescent type, may be used. Consult with your project designer or (fire) engineer to determine the need for and the type of any fire cavity barriers appropriate to your project and intended application.

Bushfire zones

EQUITONE as a fibre cement material may be used in all Bushfire Attack Levels provided that the construction is in accordance with AS 3959 – Construction of buildings in bushfire-prone areas – and the relevant provisions of the NCC. In bushfire prone areas, all cavity air inlets and outlets shall be fitted with a corrosion-resistant metal or aluminium angle or mesh adequately perforated with aperture size of 2 mm. All gaps and holes larger than 3mm shall also be covered or backed with a corrosion-resistant metal or aluminium sleeve or backing strip.

Additional considerations for applications in Bushfire Attack Level of BAL-40 & FZ:

- In BAL-40, only EQUITONE [lunara] and 12 mm EQUITONE finishes may be used unless the external wall is designed to have a Fire Resistance Level (FRL) of 30/30/30
- In BAL-FZ, the external wall shall have an FRL of 30/30/30

Refer to the 'Fire rated walls' section of this document for the fire resistant systems available from Promat Australia. For further information about the requirements of construction in BAL zones, refer to AS 3959. NCC 2022 Specification 43 – Bushfire protection for certain Class 9 buildings – provides further requirements for Class 9 buildings located in bushfire prone areas.

Design considerations

Fire rated walls

EQUITONE fibre cement materials may be installed to a fire rated wall. The required FRL is achieved with the application of appropriate fire rated solution. Promat Australia offers a range of system solutions for fire rated walls, including the following systems with Siniat Weather Defence® and PROMATECT®100. Some of these solutions are listed in Tables 11 and 12.

Table 11 – Fire resistant system solutions with steel structure – All building classes

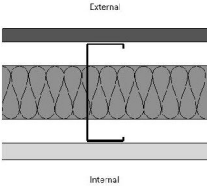
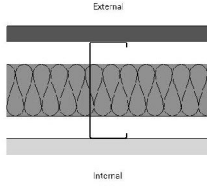
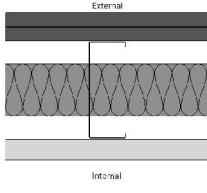
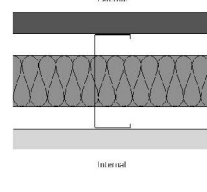
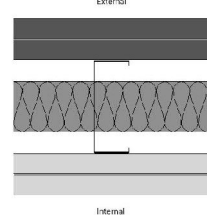
Drawing	Wall Components	Loadbearing Fire Resistance Level to AS1530.4	Non-Loadbearing Fire Resistance Level to AS1530.4	Acoustic Performance Rw (dB)	Additional Weather Protection (Sarking) Required
	External Side: 1 x 13mm Siniat Weather Defence® Frame: Steel – Min. 92mm x 35mm x 1.15BMT Internal Side: 1 x 16mm FR Plasterboard Insulation: Min. 50mm x 45kg/m3 mineral wool	60/60/60 (From both sides)	-/60/60 (From both sides)	46	No
	External Side: 1 x 15mm PROMATECT®100 Frame: Steel – Min. 92mm x 35mm x 0.55BMT Internal Side: 1 x 15mm PROMATECT®100 Insulation: As per performance required	NA	-/60/60 (From both sides)	Up to 50	Yes*
	External Side: 2 x 13mm Siniat Weather Defence® Frame: Steel – Min. 92mm x 35mm x 0.55BMT Internal Side: 1 x 20mm PROMATECT®100 Insulation: As per performance required	NA	-/120/120 (From both sides)	Up to 57	No
	External Side: 1 x 20mm PROMATECT®100 Frame: Steel – Min. 92mm x 35mm x 0.55BMT Internal Side: 1 x 20mm PROMATECT®100 Insulation: As per performance required	NA	-/120/120 (From both sides)	Up to 51	Yes*
	External Side: 2 x 20mm PROMATECT®100 Frame: Steel – Min. 92mm x 35mm x 0.55BMT Internal Side: 2 x 20mm PROMATECT®100 Insulation: As per performance required	NA	-/240/240 (From both sides)	Up to 59	Yes*

Refer to the next page for notes on this table.



For technical support and more information about Siniat and Promat fire rated system solutions visit www.promat.com/au-en, and refer to Promat Australia.

Design considerations

Table 12 – Fire resistant system solutions with *timber* structure – Class 1 & 10 buildings

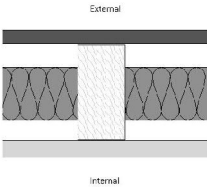
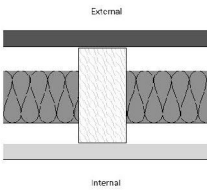
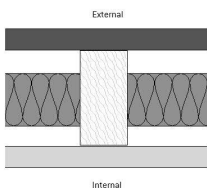
Drawing	Wall Components	Loadbearing Fire Resistance Level to AS1530.4	Non-Loadbearing Fire Resistance Level to AS1530.4	Acoustic Performance Rw (dB)	Additional weather protection (sarking) required
	External Side: 1 x 13mm Siniat Weather Defence* Frame: Timber – Min. 90mm x 45mm Internal Side: 1 x 16mm FR Plasterboard Insulation: Min. 50mm x 45kg/m3 mineral wool	60/60/60 (From both sides)	-/60/60 (From both sides)	43	No
	External Side: 1 x 15mm PROMATECT®100 Frame: Timber – Min. 90mm x 45mm Internal Side: 1 x 15mm PROMATECT®100 Insulation: As per performance required	60/60/60 (From both sides)	-/60/60 (From both sides)	Up to 41	Yes*
	External Side: 1 x 20mm PROMATECT®100 Frame: Timber – Min. 90mm x 45mm Internal Side: 1 x 20mm PROMATECT®100 Insulation: As per performance required	90/90/90 (From both sides)	-/120/120 (From both sides)	Up to 41	Yes*

Notes for Table 11 & 12

- The information provided in Table 12 & 13 is only a general guide. Please refer to Promat Australia technical services for all system performance, current validity, and construction specifics
- Acoustic predictive values modelled in Marshall Day Insul 9

* PROMATECT® 100 must be protected from weather during construction phase and in service, and therefore application of a suitable pliable membrane (sarking) immediately after board installation is required. Use without sarking must be limited only to internal dry applications. Pro clima SOLITEX EXTASANA (ADHERO) may be used to protect PROMATECT® 100 from weather in external applications.

External fixtures

Generally, no additional structural loads should be transferred to *EQUITONE* panels. Small surface mounted features like small cameras and lights may be fixed to *EQUITONE* if they are fixed only to one panel and not bridged and fixed to two or more panels. Larger surface mounted features, external fixtures, gutters, and downpipes must be fixed through an oversized hole in *EQUITONE* to structure or a dedicated support frame behind *EQUITONE* panels. The hole in *EQUITONE* should be oversized by at least 5-10 mm; the hole must be fully sealed with appropriate sealant. Services, e.g. pipes, and any additional support frame applied in the cavity for the support and fixing of any external fixtures must not block drainage and ventilation paths in the cavity.

Maintenance & warranty



Inspections

EQUITONE façade is low maintenance; however, it is recommended to regularly check the facade for any possible soiling and clean as required. All facades, irrespective of the material used, should be inspected and if necessary, serviced regularly. Regular periodic inspections and maintenance are recommended to ensure long term performance of the façade and to prevent costly repairs and rectifications in time. The building also retains its continuous and attractive appearance.

If general soiling is allowed to work into materials for too long, it is possible that it will penetrate so deeply that simple cleaning is no longer possible. More rigorous and thus more expensive cleaning methods may have to be employed.

For that reason, periodic and preventive inspection of facades is recommended, so that imperfections can be discovered and resolved or repaired in good time. All ventilation and drainage gaps must always be kept unobstructed. All flashings and seals should be regularly inspected, and any damage should be immediately repaired.

Soiling process and metal cover flashings

Dust, soot, oils, greasy substances and atmospheric grime etc. are ever present in the air and rainwater, and can be deposited on most facades. If care is taken through considerate design and application, local soiling and runs can be avoided. This can be achieved by having adequate drip-moulding, such as overhanging window sills, good sealing and attention to combat corrodible materials such as zinc, copper, aluminium, steel etc. The degree and speed at which materials become soiled largely depends on the surface, chemical stability, hardness, porosity and ability to become electrostatically charged or not.

Where the façade is protected by a soffit or the like and hence not sufficiently exposed to rain, a more regular inspection and wash down may be required to prevent any salt and dirt build up. Coastal projects may also require more regular inspections and wash downs.

In principle, perform the cleaning of the facade over the entire surface, from top to bottom because partial cleaning can result in colour tonal differences.

Cleaning

There are two methods of cleaning facades, mechanical cleaning and chemical cleaning. In principle, perform the cleaning of the facade over the entire surface, because partial cleaning can result in colour and tonal imbalance. Normal stains can be removed with a sponge and water. The use of abrasive materials such as scourers, steel wool and the like are not permitted, as these leave irreparable scratches on the panel surface.

Any cleaning product used must be ammonia free. Solvent based cleaners such as acetone, white spirit, etc. attack the paint surface and are therefore not suitable. If there is doubt on the suitability of the cleaning product, use it first on a leftover piece of the façade or a less visible part of the façade (e.g. behind rainwater drain) to check if the agent doesn't damage the surface. There is a risk that the panel colour coating may become cloudy.

Facade parts and other materials (metal parts, glass) on the building that can be affected by the cleaning agent used must be protected. Do not use tapes that leave glue residues on the surface when fixing protective cover plastic foils.

Refer to EQUITONE cleaning and maintenance documents for detailed information and guidance on cleaning and maintenance of EQUITONE facade. Where cleaning of the façade is required, it should be conducted in accordance with EQUITONE cleaning and maintenance documents and the manufacturer's recommendations of the applied cleaning product or system.

Maintenance & warranty

Efflorescence

Small amounts of lime stains, cement splashes, or limescale deposits and light efflorescence can be removed with a 5% malic acid solution or commercial citric acid in a 10% concentration. The panels are treated with the solution using a paintbrush or a soft brush. After an exposure time of 2 to 3 minutes, the remaining solution is rinsed off thoroughly with plenty of water. If efflorescence is still visible after drying, the application must be repeated. The solution should never be allowed to dry on the surface. The solution must not be allowed to come into contact with the metal supporting frame as corrosion can occur.

When working with any acid solutions the operative must be fully trained and experienced in its application and removal. There is a risk that the panel colour coating may become cloudy.

Graffiti

The EQUITONE [natura] PRO and EQUITONE [pictura] surface coating provides superior protection against common colours and spray paints. It is smooth and cleanable. Graffiti can be removed with dedicated graffiti removers. Cleaners with volatile solvents should not be used. The application instructions of the cleaning product manufacturers shall be strictly followed.

NOTE: The other EQUITONE finishes do have a graffiti resistant protection. EQUITONE [tectiva] and EQUITONE [lines] may receive an appropriate third party graffiti resistant coating, applied by others, prior to or after panel installation, in which case the appearance of the panel may change as the applied protection effects the light reflectance of the panel finish.

Panel removal or replacement

For any panel removal or replacement, first place a pin-hole punch into the mandrel hole in the rivet head and knock out the pin from the rivet. This will fall out of the back of the rivet.

Then using a 4mm drill bit, drill out the rivet head and mandrel. Do not oversize the hole in the metal support frame. Be careful to prevent drill bit slipping and scratching the panel surface. Once all the rivet heads have been removed, the panel can be gently removed.

Carefully remove the plastic rivet sleeves or spacers. Ensure during this process, the rivet holes in the frame are not oversized. Gently push any remaining part of the rivet through the hole to fall off the back of the support frame.

Where a new panel is required, it must be of the exact panel size and panel holes location as the previous panel.

It is strongly recommended that the arrangement of the fixings of the new panel is changed to avoid using the existing rivet holes in the support frame. Ensure allowance for adequate panel fixings edge distance. Otherwise, it is always recommended that the support frame is replaced with new ones where possible to not use the existing rivet holes in the support frame.



Warranty

EQUITONE product warranty is 10 years in Australia. Refer to 'EQUITONE product warranty' document for further information.

For further information about cleaning and maintenance refer to EQUITONE cleaning and maintenance documents.

For further warranty information and conditions refer to EQUITONE Product Warranty document.

Installation checklist

Checking the following items is recommended before starting the installation of EQUITONE cladding. The following list is by no means exhaustive.

Before installing weather barrier

- Ensure substructure has been designed to be serviceable for EQUITONE cladding (refer to the Design Considerations for further information).
- Ensure substructure is straight and plumb, and can adequately and structurally accommodate the required cladding framing.
- Check for and remove all sharp edges and burrs from substrate prior to application of a pliable membrane/sarking (weather barrier). Where a rigid weather barrier is intended to be used, check for any additional studs and noggins that may be required for fixing the rigid weather barrier.

After installing weather barrier

- Ensure the weather barrier and its associated components have been installed free of any defect and in accordance with their manufacturers' recommendations, project requirements and applicable standards and regulations.
- Ensure all the required flashings including those detailed in the EQUITONE Construction Details have been properly installed.

Before installing EQUITONE

- Ensure the building envelop is fully weatherproof, and all the junctions with openings and penetrations have been fully sealed as per the EQUITONE Construction Details, relevant standards and regulations, and project requirements.
- Ensure all the windows/doors (or the like) and their associated components, including any sill tray or flashing, and head and jamb flashing, have been installed as per applicable standards and regulations, project requirements, and EQUITONE Construction Details.
- Ensure adequate ground clearance as per EQUITONE Construction Details and regulatory requirements. Determine and mark bottom of the cladding.
- Ensure the cladding support frame has been installed correctly, straight and plumb, and in accordance with project engineering design and relevant standards, and spaced as per engineering requirements and EQUITONE span tables.
- Ensure all the required flashings have been installed correctly and in accordance with applicable standards and regulations, project requirements and EQUITONE Construction Details.
- Confirm the need for any additional structural support required for accommodating any external fixtures or surface mounted features. Under no circumstances should EQUITONE panels receive any additional structural loads. Any applied additional supports must not block the air flow and drainage within the cavity.
- Confirm all the interfaces with EQUITONE, review architectural drawings as well as EQUITONE Construction Details and prepare accordingly.
- Ensure panel sizes are correct, and all panel holes have been predrilled with 11 mm EQUITONE bit with correct spacing and adequate edge distances.
- Ensure all panel edges are sanded and free of any dust. In case of EQUITONE [natura] and EQUITONE [natura] PRO, ensure all panel edges have been fully sealed with LUKO.
- Ensure allowance for adequate air inlets and outlets, and ventilation within the cavity has been made, and the perforated angles or profiles have been installed where required.
- Ensure the required EPDM compressible gaskets have been applied on all support frame profiles as per the requirements outlined in this documents and EQUITONE Construction Details.
- Ensure full knowledge of the correct location of the two STOP points UNI Rivets per panel, and correct sequence of panel fixings' application.



For a step-by-step guide and information on the application of pro clima weather barrier and its components refer to SOLITEX EXTASANA® Application and Fixing Guides.

For further information regarding weather barrier refer to Design Consideration section.



Check the quality of EQUITONE panels and components for any visual defects or damage prior to installation. Contact your local EQUITONE organisation for any issues. DO NOT install any panels or components which are either damaged or not aligned with the project requirements and specifications.

Installation checklist



Check the quality of EQUITONE panels and components for any visual defects or damage prior to installation. Contact your local EQUITONE organisation for any issues. DO NOT install any panels or components which are either damaged or not aligned with the project requirements and specifications.

The following list is by no means exhaustive. It needs to be used in conjunction with other relevant EQUITONE technical documents.

Installation checklist

- Before placing any panel on the façade, check the size of the panel, location/spacing of the pre-drilled panel holes, and the edge distances are all correct. Ensure the panel is clean and free of any dust.
- Ensure the location of the two STOP point fixings per panel is correct.
- Ensure EQUITONE centralising tool with 4.1 mm drill is used for drilling the rivet holes in the support frame. Centralising tool shall be held perpendicular to panel face.
- Ensure any metal swart is fully removed from the panel holes prior to the application of UNI rivet.
- Ensure STOP points are first applied. STOP point fixings must be applied one at a time i.e. drill rivet hole using centralising tool and then apply the first STOP point UNI rivet; repeat the same for the second STOP point rivet. Temporary screw fixing is NOT allowed.
- Ensure GO point rivet are applied after the STOP point rivets. For drilling rivet holes using centralising tool, first start with the holes close to the panel centre and then move towards panel edges.
- Adopt appropriate level of care to prevent any damage to panel finish and edges during panel installation.
- Ensure correct application of rivet gun, and use of EQUITONE rivet setting tool. Ensure all panel fixings are applied.
- Ensure the thickness of any perforated profile, flashings, and the like located between panel and support frame is not greater than 0.8 mm.
- Ensure allowance for control/movement joints e.g. under side of the slabs. Ensure panel and/or its support frame does not bridge any control/movement joint while fixed to both sides of it.
- Ensure allowance for control and movement joints e.g. under side of the slabs. Ensure panel and/or its support frame does not bridge any control or movement joints while fixed to both sides of the control/movement joint.
- Ensure allowance for adequate ventilation is made. Ensure adequate air inlet and air outlet at the bottom/top of the façade, interface with window sills and heads and the like, junctions with slabs and soffits are allowed.
- Ensure all necessary coordination is done with other trades to ensure allowance for adequate air inlets and outlets (ventilation) as per EQUITONE ventilation requirements.

After installation

- Check the façade for any missing fixings, flashings, items, or defects.
- Ensure panels are adequately protected after the installation where there is any risk of damage by other works.
- Ensure the panels are cleaned after the installation in accordance with EQUITONE cleaning guidelines. The finished facade areas should be cleaned down following fixing of panels. Any partial cleaning may cause minor visual impairments.

