



 **EQUITONE**

design & installation guide

EQUITONE with concealed fixings

Australia



Contents

Introduction	2		
General information	2		
About EQUITONE	2		
Disclaimer	2		
EQUITONE materials	3		
Materials	3		
Maximum panel sizes	4		
EQUITONE facade	5		
Ventilated façade	5		
General components	7		
Cladding components	7		
Recommended weather (resistive) barrier options	8		
Weather barrier components	9		
Accessories	10		
General accessories	10		
Material specific accessories	10		
Support frame	11		
Panel storage	13		
General requirements	13		
Outside storage	13		
Other trades	13		
Panels on edge	14		
Stacking panels	14		
Pallets	14		
Moving panel	15		
Lifting	15		
Forklift	15		
Panel handling	16		
Handling	16		
Suction lifters	16		
Carrying Straps	16		
Gloves	16		
Panel preparation	17		
Tools & accessories	17		
Health & safety	17		
		Panel cutting	18
		Panel drilling	20
		Panel holes edge distance	22
		EQUITONE [natura] edge treatment	23
		Panel installation	24
		Tools and accessories	24
		Installation of hangers	25
		Installation of vertical rails	26
		Installation of horizontal rails	27
		Panel joints	29
		Panel Installation	32
		Protection of installed panels	36
		Coordination with other trades	36
		Typical construction details	36
		Engineering	37
		General information	37
		Wall application	37
		Ceiling/soffit application	42
		Design considerations	46
		Application	46
		Weatherproofing	49
		Impact resistance	50
		Corrosion zones	51
		Cyclonic areas	51
		External fixtures	51
		Fire safety	51
		Bushfire zones	52
		Fire rated walls	53
		Maintenance & warranty	55
		Inspections	55
		Soiling process and metal cover flashings	55
		Cleaning	55
		Efflorescence	56
		Graffiti	56
		Warranty	56
		Installation checklist	57
		Notes	58

Introduction

General information

This Design and Installation Guide serves only as a general guide providing basic design considerations and information in relation to the application and installation of EQUITONE using the recommended third party concealed fixing solutions for common external applications. This guide illustrates that the installation of EQUITONE fibre cement façade materials with the recommended fixing systems is straight forward, provided some simple rules are followed.

EQUITONE typical construction details are available as separate documents which must be read in conjunction with this Design and Installation Guide.

About EQUITONE

EQUITONE is the world's leading architectural fibre cement facade material. EQUITONE evokes the unique characteristics of fibre cement. Fibre cement is a mineral composite with outstanding physical and aesthetic properties. Our company, Etex, has led development and innovation of this versatile architectural building material for more than a century, under different brand names such as "Eternit". Today, EQUITONE is manufactured in state-of-the-art facilities in Germany, Belgium, and Poland.

EQUITONE façade materials and systems are CodeMark certified in Australia. For more details, please refer to the CodeMark certificates available at www.equitone.com.



Disclaimer

The information in this guide is comprehensive but not exhaustive, and the reader will need to satisfy themselves that the contents of this guide are suitable for their intended application. It is the responsibility of the project consultants (designer, architect, and engineers) to ensure that the information and details provided in this document are appropriate for the project.

The provided information about SFS, NVELOPE, and/or Fischer systems and their application and installation procedures in this document is based on the advice received from the supplier of these systems. For any further information, queries and/or technical assistance in relation to these systems and their correct applications refer to their suppliers. This document is supplied only in good faith and no liability can be accepted for any loss or damage resulting from its use.

The information in this document is correct at the time of issuing. However, due to our committed program of continuous material and system development we reserve the right to amend or alter the information contained in this document without prior notice. Please contact your local EQUITONE sales organisation or visit www.equitone.com to ensure you have the most current version.

Images and construction details contained in this document are not to a specific scale, and are indicative and for illustration purposes only.

This document is protected by International copyright laws. Reproduction and distribution in whole or in part without prior written permission is strictly prohibited. EQUITONE and logos are trademarks of Etex NV or an affiliate thereof. Any use without authorisation is strictly prohibited and may violate trademark laws.

EQUITONE materials

Materials

The Minerals



For detailed information about EQUITONE materials, manufacturing tolerances and their technical properties, refer to their Material Information Sheet available from local EQUITONE website.

EQUITONE finishes are available in a variety of colours. For all available colours refer to local EQUITONE website.



EQUITONE [tectiva] is a through-coloured, uncoated fibre cement facade material, characterised by a sanded surface and naturally occurring hues within the material. Every [tectiva] panel is unique, strongly expressing the raw texture of the core fibre cement material.

Thickness	Weight
8 mm	14.9 Kg/m ²
10 mm*	18.6 Kg/m ²

* 10 mm thick panels are available on request, subject to minimum order quantities.



EQUITONE [lines] is a unique 3D shaped, through-coloured fibre cement facade material that plays with light and shadow. EQUITONE [lines] with longitudinal grooves displays a linear texture that highlights the raw inner texture of the core fibre cement material. Every moment of the day, the changing angle of the daylight gives the facade material a different aspect.

Thickness	Weight
10 mm	16.8 Kg/m ²

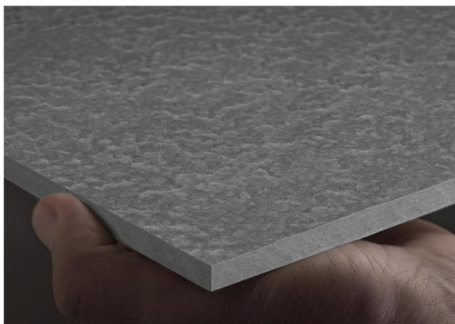

A through-coloured, uncoated fibre cement facade material, EQUITONE [lunara] embodies an honest and pure appearance. Featuring a unique texture, the surface of the panel is determined by a randomised surface treatment, which means no recurring pattern and no two panels being the same. Each facade is unique. Naturally occurring colour differences are also accentuated by the surface, as the extraordinary look and feel emphasises the originality of the fibre cement material.

Thickness	Weight
10 mm	18.6 kg/m ²



EQUITONE [natura] is a through coloured fibre cement base board, with a semi-transparent coloured finish, subtly displaying the raw texture of the core fibre cement material. The rear face has a transparent sealing coating.

EQUITONE [natura] is also available in PRO, comprised of a UV-hardened, anti-graffiti and scratch resistant surface coating. EQUITONE [natura] PRO offers protection against common spray paints and scratches, making it an ideal choice for internal and high traffic areas.

Thickness	Weight
8 mm	15.4 Kg/m ²
12 mm	22.8 Kg/m ²

EQUITONE materials



The Colourfuls



EQUITONE [pictura] is a fibre cement facade material with ultra matt architectural finish comprised of a UV-hardened, anti-graffiti and scratch resistant surface coating.

Thickness	Weight
8 mm	15.4 Kg/m ²
12 mm	22.8 Kg/m ²

The Graphicals

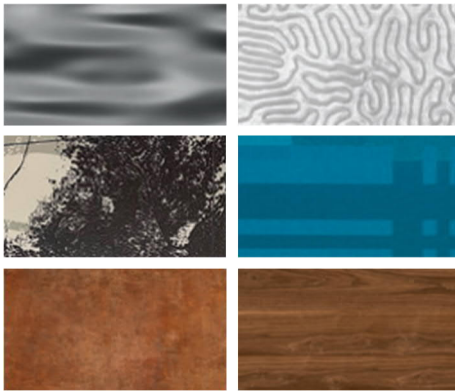

EQUITONE [inspira] is a high-density fibre cement panel with a digital printed surface covered with a UV finishing.

The surface finish is smooth, hard, and matt. The UV finishing provides a hard, dirt resistant surface finish with a high abrasion resistance and a permanent and durable anti-graffiti surface. Available in two ranges:

- 1) Expressive surfaces with wood, rust, concrete and stone decors
- 2) Artistic and special surfaces

Thickness	Weight
8 mm	16.8 Kg/m ²

Maximum panel sizes

EQUITONE [tectiva]
EQUITONE [lines]
EQUITONE [lunara]

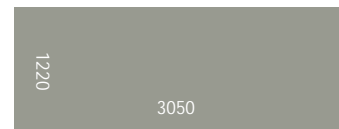

EQUITONE [natura]
EQUITONE [natura] PRO
EQUITONE [pictura]
EQUITONE [inspira]

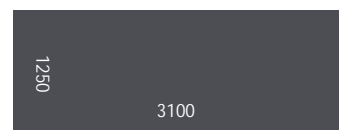
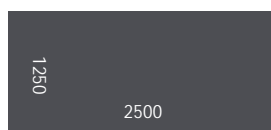

EQUITONE facade

Ventilated façade

EQUITONE has been designed for a ventilated façade system. A ventilated façade is a kind of two stage construction, an inner structure with a protective outer skin, and the cladding panel or rainscreen. A ventilated façade consists of an insulated and weathertight structure, a ventilated cavity formed with a cladding support frame and the cladding panel.

The concept for the 4 D's of Weathertightness is another simple way of explaining a Ventilated Façade. This principle is gaining popularity as it draws particular attention not only to the weathertightness of a building envelop with proper application of a suitable weather barrier, but also to the application of appropriate flashings and the like for the deflection and directing of any moisture, entering the cladding cavity, out and away from the façade rather than over-relying on any exposed sealants and sealing of cladding skin.

Deflection: Proper detailing of façade and flashings for deflection, with the aim of keeping water out

Drainage: Allowance for clear paths for the water to drain outside, should water get in

Drying: Adequate provision for ventilation and vapour diffusion within cladding cavity to eliminate remaining water

Durable: Use of components with adequate durability appropriate to the project location

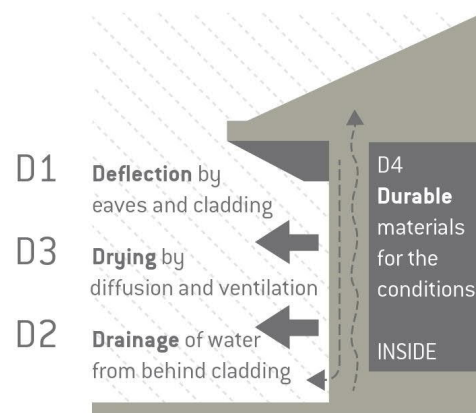

Allowance for adequate ventilation is paramount in ensuring a successful EQUITONE façade. A ventilated façade provides a number of added benefits to the building and its occupants. These may include but are not limited to the following:

- Positive contribution to energy savings
- Assists with condensation management
- Minimises thermal bridges by providing an opportunity for applying external insulation
- Reduces thermal movement of the structure and cladding support frame
- Dissipates radiant heat
- Increases acoustic performance of the external wall
- Provides an effective drainage path for any moisture passing the cladding skin
- Eliminates the need for exposed caulking and sealant, therefore reducing maintenance requirements
- Assists with keeping the weather barrier dry and healthy
- Provides opportunities for concealing external services such as downpipes within the cavity
- Proven to be a more sustainable and healthier façade construction
- Architectural design flexibility

EQUITONE facade



Air must be allowed to enter the cavity from the bottom of the façade, window head, soffit, slab junctions, and the like, and exit from the top of the façade, capping, window sill, slab and soffit interfaces, and the like.

The size of air inlets and outlets depends on the height of the façade and the vertical distance between them. For effective ventilation, the size of air inlet should always be greater than or equal to the size of air outlet.

The following is a general recommendation for the size of air inlets and outlets on a closed joint façade, i.e. where the horizontal joints located between air inlets and outlets are closed (baffled).

Vertical distance between air inlet and air outlet (m)	Min. size of air inlet/outlet (Without a perforated profile) (mm)	Min. size of air inlet/outlet (With a perforated profile with a 50% open area) (mm)
< 5	10	20
< 10	15	30
< 20	20	40
< 50	25	50
< 75	30	60
< 100	35	70

It is recommended that all air inlets and outlets are protected against entry of birds and vermin into the cavity with a corrosion resistant perforated profile (angle). The thickness of the perforated profile placed between the cladding panel and support frame should not exceed 0.8 mm. The open area percentage of the profile and the size of the air inlet and outlet are crucial factors in ensuring adequate ventilation. The minimum ventilation allowance is 100 cm²/m, but this may need to be increased depending on the distance between the air inlets and outlets. The recommended minimum perforation percentage of the profile is 50%. Profiles with less open area result in larger air inlet and outlet sizes. Refer to the above table for the minimum recommended air gap sizes with and without a perforated profile with a 50% open area. The aperture size of the profile is recommended to be between 3 mm to 5 mm*.

The perforations (air inlets and outlets) must be kept open and unobstructed to maintain drainage and ventilation of the cavity. The perforated angle shall be positioned to allow an adequate drip edge to the cladding panel.

At the base of the façade, typically a minimum 150mm above the finished ground/floor level is recommended. This will help prevent rain splash-back from the ground while maintaining sufficient space for the air to enter the cavity. Where rain splash-back effect is not a concern, e.g. in covered areas, the above recommended minimum air inlet sizes provided with respect to the distance between air inlet and outlet apply.

No planting of garden, decorative or ornamental plants should be allowed near the air inlets as over time these may block the air inlets.

Refer to the 'Design considerations' section for information about the required minimum cavity width.

* In bushfire prone areas, the maximum aperture size of the perforated profiles covering air inlets and outlets should not exceed 2 mm. Refer to the 'Bushfire zones' section of the 'Design considerations' part of this document for further information and considerations for applications in bushfire prone areas.

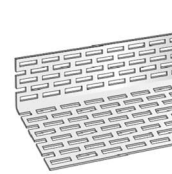
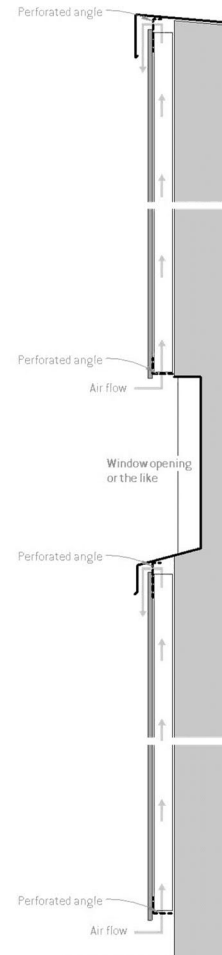

General components

Cladding components

SFS TUF-S

EQUITONE may be installed with TUF-S concealed fixing solution, available from SFS, to a suitable cladding framing system. TUF-S can be applied to panels without requiring any special tools or CNC machinery.

TUF-S, excluding the mandrel, is made of grade 316 (A4) stainless steel. The mandrel is carbon steel zined and is completely removed once TUF-S is applied.

Available sizes:

For 8 mm EQUITONE panel, EQUITONE [lines], and EQUITONE [lunara]

TUF-S	Panel blind hole depth (mm)
TUF-S-6x9	5.5

For 12 mm EQUITONE panel

TUF-S	Panel blind hole depth (mm)
TUF-S-6x12	8.5

* The above sizes and embedment values are based on 3.5 mm hanger thickness. Hanger is a component of the support frame, which is fixed with TUF-S to the rear of EQUITONE.



SFS



For further information about TUF-S and Tergo+ fixings and their technical properties, refer to your local supplier of SFS/Fischer systems.



This Design and Installation Guide does not cover the application of Fischer Tergo+ fixing solution. Please contact your local EQUITONE technical department for information about the application of this fixing system and its required tools and accessories.



Fischer Tergo+ (Alternative fixing solution)

Tergo+, a fixing system of Fischer, is an undercut anchor used for concealed fixing of EQUITONE panels. This fixing system requires special equipment or CNC machinery for drilling the undercut holes at the back of EQUITONE panels.



Tergo+ fixing solution is not available for the following materials: 8mm EQUITONE [natura], 8mm EQUITONE [natura] PRO, 8 mm EQUITONE [pictura] and EQUITONE [inspira].

Available sizes:

For EQUITONE [tectiva], EQUITONE [lines], and EQUITONE [lunara]

Tergo+	Embedment depth (mm)	Thread length (mm), 'b'
 11x6 M6/T/10 PA	6	10
 11x6 M6/T/13 PA	6	13

For 12 mm EQUITONE panel

Tergo+	Embedment depth (mm)	Thread length (mm), 'b'
 11x8 M6/T/10 PA	8	10
 11x8 M6/T/13 PA	8	13



fischer 

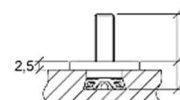

General components

Compressible EPDM gasket

A compressible closed-cell EPDM gasket is used for sealing interfaces with flashings and the like as specified on EQUITONE Construction Details.

Recommended options:

- 12mm Tesa® 66703
- 12mm Tesa® 61102
- 12mm Tesa® 60106 (PVC)



Double sided foam gasket

A double sided closed-cell PE foam gasket may be used for fixing the baffle to back of the panels on baffled horizontal joints.

- Tesa® 62936



NV3 horizontal express joint backing trim (baffle)

Black coated aluminium baffle is used to form expressed horizontal joints.

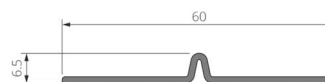

NV3 vertical express joint backing trim

Black coated aluminium backing trim is used to form expressed vertical joints.



Recommended weather (resistive) barrier options

Weather barrier option 1

pro clima SOLITEX EXTASANA® flexible air barrier

EQUITONE façade systems have been independently assessed and certified with pro clima SOLITEX EXTASANA® for the purpose of compliance with NCC 2022 F3P1 & H2P2 for the following wind pressures calculated to AS1170.2.

- Serviceability wind pressure: $\pm 2\text{KPa}$
- Ultimate wind pressure: $\pm 3\text{KPa}$

pro clima SOLITEX EXTASANA® shall be applied in accordance with AS4200.2 and pro clima SOLITEX EXTASANA® installation guidelines.



For information about technical properties and correct application of pro clima products, refer to pro clima technical documents, and SOLITEX EXTASANA® Application and Fixing Guides.

For information about Siniat Weather Defence® and its technical properties and application, refer to Siniat technical documents which are available at www.siniat.com.au/en-au/.

For further information regarding selection of appropriate weather barrier, refer to Design Considerations section of this document.

General components

Weather barrier option 2

Siniat Weather Defence® rigid air barrier

EQUITONE façade systems have been independently assessed and certified with Siniat Weather Defence® for the purpose of compliance with NCC 2022 F3P1 & H2P2 for the following wind pressures calculated to AS1170.2.

- Serviceability wind pressure: $\pm 2.5\text{KPa}$
- Ultimate wind pressure: $\pm 4.5\text{KPa}$

Siniat Weather Defence® shall be applied in accordance with Siniat Weather Defence® installation guidelines.



Weather barrier components

Flashing tape pro clima TESCON EXTORA®

A pressure sensitive adhesive tape for overlaps, end laps and taping on to flashings and the like. Used with both weather resistive barrier options.



Sill tape pro clima TESCON EXTOSEAL®

A flexible tape for use around window and door openings, used with both weather resistive barrier options.



Sealing tape pro clima TESCON® NAIDECK mono patch

A single-sided adhesive nail or screw sealing adhesive used with both weather resistive barrier options.



Foil tape¹ pro clima TESCON® ADHISO WS

A pure aluminium tape for wet seal connections to TESCON EXTOSEAL® and EXTORA® and SOLITEX EXTASANA®.



Grommet pro clima ROFLEX and KALFEX

pro clima ROFLEX is used to seal pipe and pro clima KAFLEX for cable penetrations. pro clima ROFLEX and KALFEX are used with both weather resistive barrier options.



PRESSFIX A malleable plastic tool for applying pressure to pro clima Adhesive TESCON® Tapes to ensure long term durable bonding.



¹ Foil tape is optional and not required when using sealants which are compatible with TESCON EXTOSEAL® and EXTORA® and SOLITEX EXTASANA®. Check with the sealant manufacturer for compatibility with pro clima products.

General accessories

EQUITONE saw blades

These blades have been designed especially for cutting high density fibre cement panels, and when correctly used, result in a high level of finish. The blade is unique with its minimal diamond tipped teeth which are shaped to give a tear-free edge, and its vibration damping composite body construction. These blades can remain good for up to 5,000m of cutting providing it is correctly used. The blades are available in the following sizes:

- 160 mm diameter with 4 diamond tipped teeth and 20 mm centre hole diameter
- 190 mm diameter with 4 diamond tipped teeth and 30 mm centre hole diameter
- 225 mm diameter with 6 diamond tipped teeth and 30 mm centre hole diameter
- 300 mm diameter with 8 diamond tipped teeth and 30 mm centre hole diameter



Jigsaw blade (for curved cutting only)

Bosch T141HM jigsaw blade is recommended for curved cut-outs. It is available in a pack of three.



SFS VHM drill bit

Replaceable carbon steel drill bits with different lengths, used for drilling blind holes at the back of EQUITONE panels. It assures a correct blind hole when used with the depth locator. Recommended drill bits:

- For 8 mm EQUITONE panel, and EQUITONE [lines]:
VHM-6,0x40,5 for 5.5 mm panel hole depth
- For 12 mm EQUITONE panel:
VHM-6,0x43,5 for 8.5 mm panel hole depth



SFS depth locator universal

Depth locator assures a correct blind hole for SFS TUF-S fixings. The depth locator comes without a drill-bit.



Material specific accessories

LUKO edge sealer for EQUITONE [natura] & EQUITONE [natura] PRO¹

LUKO is a translucent liquid sealer that is applied to the cut edges of [natura] and [natura] PRO panels to help prevent moisture ingress in the panel. It is available in 0.5, 1, and 10 litre containers. Depending on the application, 0.5 L of LUKO could cover up to 500 linear metres of panel edge.



LUKO application kit for EQUITONE [natura] & EQUITONE [natura] PRO¹

A LUKO application kit, including an applicator and tray, is available to assist with the correct application of LUKO. Replacement sponges are also available.

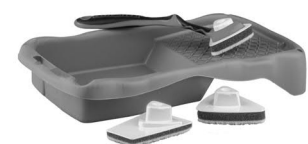

¹ It is also possible to apply LUKO to the cut edges of [pictura] to prevent any possible risk of whitening of the edges (efflorescence).

Support frame



It is advisable to use a vertical profile that allows for some degree of installation tolerance.

Support frame should have adequate corrosion resistance appropriate to the location of the project. It is the responsibility of project engineer or designer to determine the level of corrosion resistance and suitable support frame with adequate corrosion resistance required for the intended application.

Metal support frame profiles should be compliant with AS/NZS 4600 – Cold-formed steel structures and/or other applicable standards.

Maximum deflection of support frame must be limited to $\text{Span}/250$.

EQUITONE may be concealed fixed to NVELOPE NV3 framing system. NVELOPE NV3 system comprises of the following components.

NV3 hangers

Hangers are fixed to the back of EQUITONE panels with SFS TUF-S fixings. There are two types of hangers:

- Levelling (adjustable) hangers
Hangers located close to the top edge of a panel (top row hangers) are of levelling or adjustable type. This allows for some degree ($\pm 5 \text{ mm}$) of panel levelling when required. This hanger comes with an adjustment bolt. These hangers support the weight of the panel.
- Static hangers
The rest of the hangers on a panel are static hangers with no means of adjustment. These hangers are used to resist the wind loads.



NV3 horizontal carrier rail

The hangers on the rear of the panel hang on horizontal rails. The hangers and horizontal rails interlock with each other. The horizontal rail is rivet or screw fixed to the vertical L profiles. This is done with fixed and gliding points. Each horizontal rail is normally 3 m long.



Vertical support frame

NV3 horizontal carrier rail is fixed to a vertical support frame which forms a clear path for ventilation and drainage within the cavity.

Option 1: NV3 bracketry system

This type of support frame generally comprises vertical aluminium rails, to which the horizontal carrier rails are fixed, and brackets connecting the vertical rails to the substructure. NVELOPE offers a range of aluminium bracketry systems commonly used with EQUITONE.

NVELOPE brackets are available in various depths suiting different or varying cavity widths. The smallest cavity width with the NV3 bracketry system is approximately 75mm equating to the overall bracket depth plus the depth of the horizontal carrier rail and hanger.

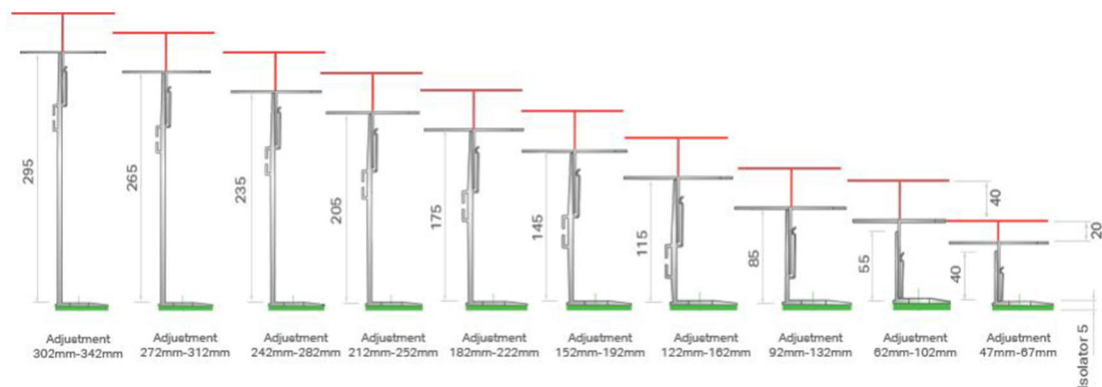
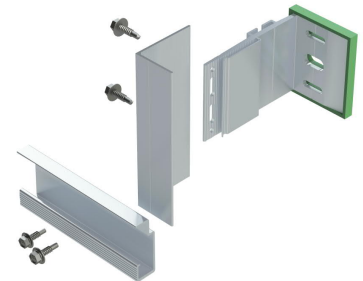

NVELOPE brackets suiting various cavity widths

Support frame

The vertical rails are generally available in 'L' & 'T' sections.

NVELOPE also offers a proprietary thermal isolator gasket, with an R-value of 0.04, suiting NVELOPE brackets to reduce thermal bridging.

Instances where a bracketry framing system may be used include, but are not limited to, the following:

- Where cladding cavity width varies either due to design or uneven substrate
- Where a wider cavity is required
- Where external insulation is intended to be used
- Where vertical movement allowance within the connection of cladding framing and substructure is required e.g. where cladding framing bridges over a horizontal control joint, for instance at floor junctions, and needs to be fixed to the substructure on both sides of the joint. In this case, this type of framing may be used provided that the size of the elongated holes of the brackets suits the required movement allowance

Option 2: NV9 vertical rails

Where a bracketry framing system is not required, NV3 horizontal carrier rails may be fixed to NV9 vertical aluminium Zed or Omega rails available in 25 mm and 40 mm depths. 25 mm deep vertical profile will result in an approximately 50 mm overall cavity width.

Available profiles:

- Omega 120 x 25 mm
- Omega 140 x 40 mm
- Zed 45 x 30 x 25 mm
- Zed 45 x 55 x 40 mm

Option 3: Vertical metal top hats

Where appropriate, vertical metal top hats of minimum 25 mm depth and 1.1 mm Base Metal Thickness (BMT) may be used. In this case, a suitable metal separator is required to separate the metal from aluminium to reduce the risk of any bimetal corrosion.



NVELOPE 'T' & 'L' profile



NVELOPE thermal isolator

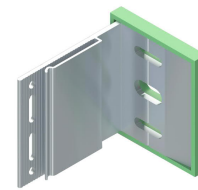

Example of NVELOPE bracket with thermal isolator

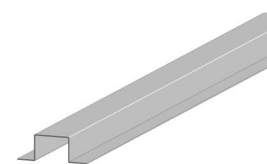
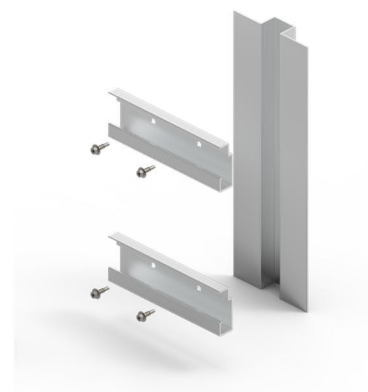



For further information about NVELOPE components and product specifications, refer to the supplier of NVELOPE systems.

The application of NVELOPE systems shall be in accordance with its supplier's recommendations and guidelines.

Minimum typical cavity width (depth) is 50 mm. Where smaller cavity width is required, consult with your local EQUITONE technical department.

Panel storage

General requirements

EQUITONE panels must be stored flat on pallets, inside and undercover in dry conditions, protected from weather and potential influence of other trades. Store products clear of the ground and on level bearers at a maximum of 600mm centres.



Before installed ventilated, EQUITONE panels must not get wet.

Do not deliver any panels to site which cannot be installed immediately or unloaded into a suitable well protected storage area.

EQUITONE is a prefinished material and poor or inadequate storage will increase the risk of damage to the finished surfaces.

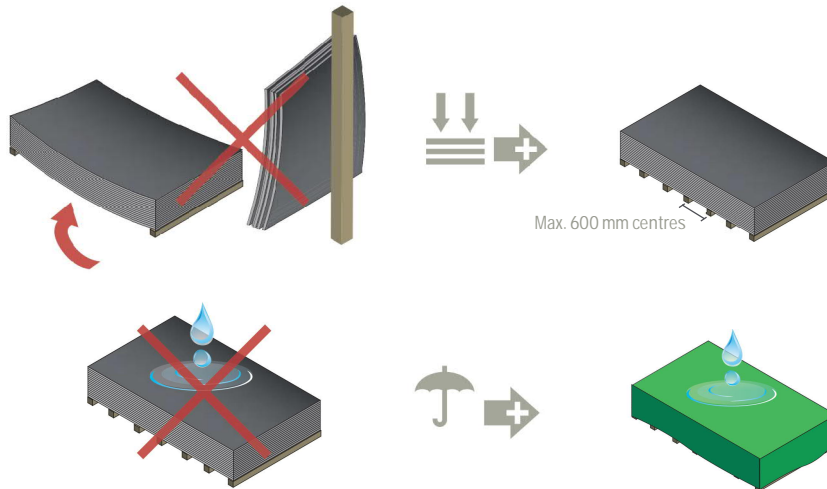

Outside storage

Where panels must be stored outside, extra care and attention is needed to protect them from rain and direct sun. Remove the outer plastic protection as this may cause condensation if left in place especially in direct sunlight.

Protect the pallet from rain or condensation by covering the pallet with an opaque waterproof cover like tarpaulin. This cover must be provided with a slope, so all moisture runs off quickly and must not be allowed to pond on the pallets. This will also allow the air to circulate around the panels. Use only opaque coverings. Clear plastic is not recommended.

If moisture can penetrate between the stored panels, permanent surface staining in the form of efflorescence may occur and may prevent the panels being used.

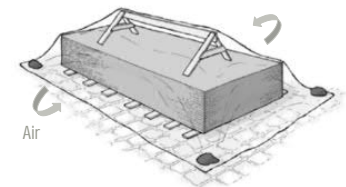

Other trades

Be aware of other trades on the job site as they may not respect the material in the same way.

Do not leave material in such a way that allows people to walk over the panels as this will leave footprints on the surface.

These prints may scratch the panels or leave an oily residue on the surface, which could permanently stain the panel.

It is advisable to barricade the storage area and workstation around the panels to reduce any risk of damage by other trades.

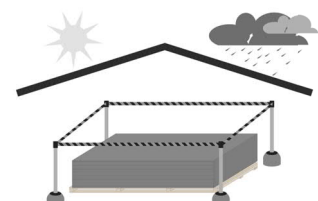

Panel storage



Panels on edge

When storing EQUITONE panels on their edges, use soft supports such as pieces of insulation or rubber faced timber battens to rest the edge on. This can help prevent chipping or edge damage.

Only leave panels stored on their edge for a short time (maximum 1 hour) and never in wet weather. Standing the panel on its edge is not a long-term method of storage and may cause deformation.

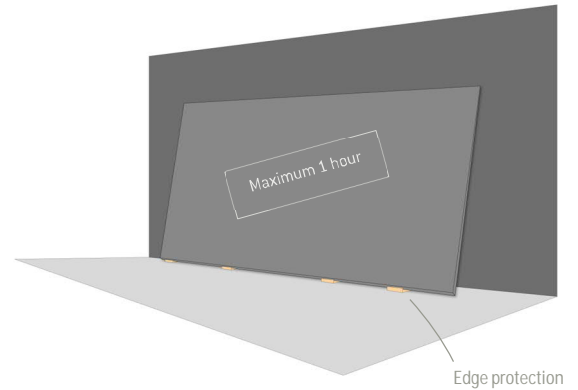

Stacking panels

EQUITONE [natura], [natura] PRO, and [pictura]

These EQUITONE panels are supplied with protective film between the decorated faces. This interleaving foam must not be removed.

When restacking these panels:

- Stack the panels front-face-to-front-face or back-surface-to-back-surface. The panels should not be placed face-to-back.
- Reuse the interleaving foam between each layer which is face-to-face to prevent scratches.

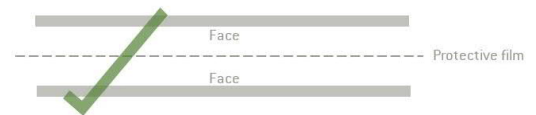

EQUITONE [inspira]

EQUITONE [Inspira] panels are supplied with interleaving protective foam. The panels are stacked front-to-back with the foam, which must always remain between the panels when restacking.



EQUITONE [lines]

EQUITONE [lines] panels are stacked front-face-to-back-surface with a protective spacer in between. Only the first two top panels on a pallet are positioned front-face-to-front-face to reduce the risk of damage to the top panel face during transport and storage, while the rest of the panels on a pallet must be stacked front-face-to-back-surface.

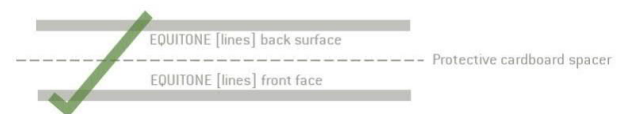

EQUITONE [tectiva] & [lunara]

EQUITONE [tectiva] and [lunara] panels may be stacked front-face-to-back-surface with no protective spacer or film in between the panels.

Pallets

Pallets are to be kept in a good condition. Damaged or broken pallets increase risk of damage to the panels. When sorting from one pallet to another ensure that the timber pallets are oversized or larger than panels to prevent possible damage to the panel edges. Individual pallets can be 500mm high, and not more than 5 pallets can be put on top of one another provided the ground is flat and level.

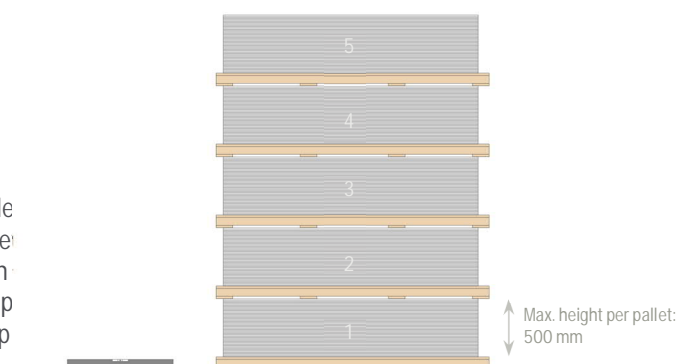

Moving panel

Lifting

Moving panels that are stacked on pallets should be done with a forklift or a crane.

Ensure the panels are secured to the pallet in a way that will not cause damage. Soft protection is needed where straps touch the panels.

Stacks should be transported under a waterproof cover.

When lifting with straps, position them so the panels are balanced and there is no risk of tipping over. Use wide straps or edge protection to prevent damage.

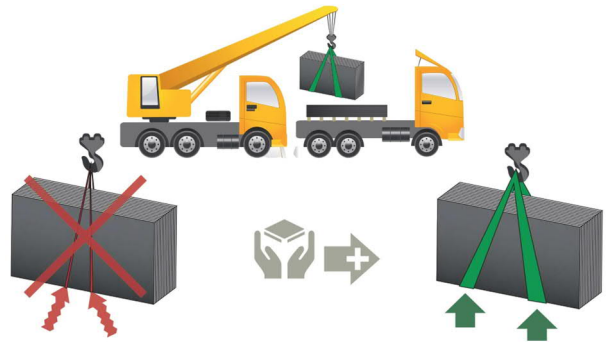

Forklift

When moving the pallets with a forklift, it is recommended that a multi-fork attachment (4 forks) is used.

If using the standard 2 fork attachment, these must be positioned with a wide setting. This will stop the pallets bending when lifted.

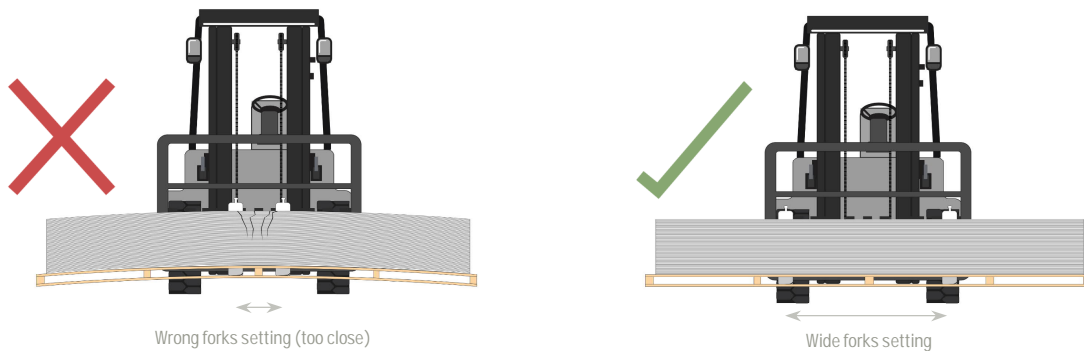

Panel handling

Handling

Plan carefully how the panels will be handled. Decide on a suitable route for moving the panel from the storage area to the facade and then up the façade. Be aware of obstacles such as scaffolding, temporary supports or uneven walking surfaces.

Always lift panels off each other, never slide them over one another, since scratching may occur on the surface.

To carry the panels, stand them on their back edge on soft bearers and lift with two people, one person at each end, protecting the panel face from scratching or damage.

Always lean the panel towards its back edge to avoid damaging the visible front edge.

Always respect Health & Safety guidelines in all aspects of manual handling.

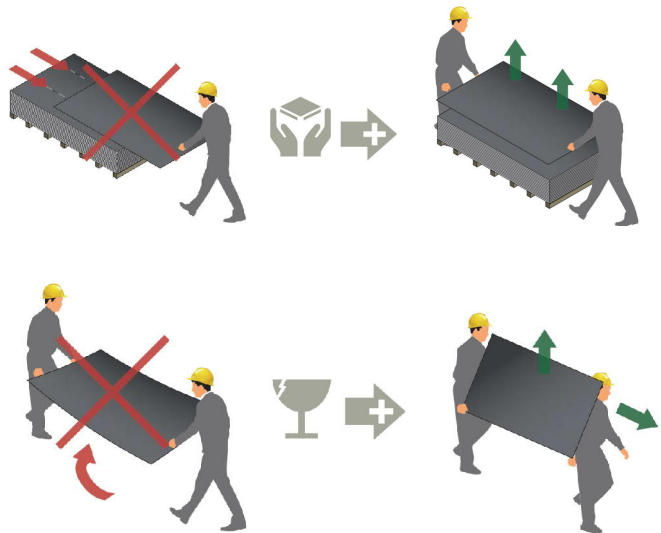

Suction lifters

When suction lifters are used to lift and move panels, it is important to ensure they are strong enough. Only suitable with the smooth surface panels.

However, there is a high risk of leaving marks on the panel and therefore a test needs to be carried out to ensure the suction cups do not leave any marks on the panel surface e.g. because of the rubber's oily surface. The suction cups must be perfectly clean.



Carrying Straps

To ease the lifting of large panels, carrying or manual lifting straps can be used. Make sure the strap material will not damage the panel edges. Take care when removing the straps.



Gloves

Clean gloves must be used to prevent fingerprints on the panels. Gloves should be of a type that ensures good grip and are easily cleaned. Make sure the gloves are waterproof if working in damp or wet weather and will not cause any risk of cement dust reaching the skin as this may cause irritation.

At times when working with white EQUITONE panels wearing cotton work gloves prevents staining. Make sure gloves are always clean.

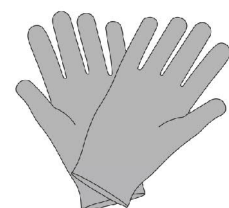

Panel preparation

Tools & accessories

General tools and accessories required for panel preparation are as follows. The following list is by no means exhaustive.



EQUITONE blade for manual cutting



Bosch T141HM jigsaw blade for curved cuts

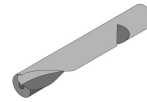

SFS VHM drill bit

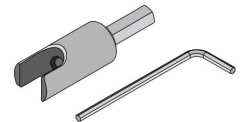

SFS depth locator universal



80 grit sandpaper for sanding panel edges (to be affixed to a timber block)



LUKO sealer & LUKO applicator kit for edge sealing of EQUITONE [natura] & EQUITONE [natura] PRO



Paper towel for removing any LUKO residue

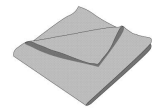

Clean microfibre cloth for dust removal

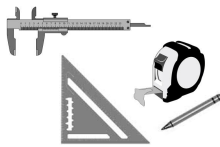

Measuring tools & pencil for marking

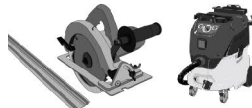

Saw, guiderail, & vacuum for panel cutting



Jigsaw for curved cut-outs



Drill for panel drilling

Health & safety

As with all products containing quartz, e.g. concrete and clay, when EQUITONE panels are machined mechanically (cutting, sanding, drilling) the released dust may contain quartz particles. Inhalation of high concentrations of dust may irritate the airways, and dust may also cause irritation of eyes and/or skin. Inhalation of dust containing quartz, especially fine (respirable size) particulate matter, in high concentrations over prolonged periods of time, can lead to lung disease (silicosis) and an increased risk of lung cancer.

- Avoid dust inhalation with the use of cutting/sanding equipment fitted with dust extraction/suppression accessories wherever practical
- Ensure adequate ventilation of all work sites
- Avoid contact with eyes and skin by wearing an approved respirator (a dust mask compliant with AS/NZS 1715 and AS/NZS 1716) together with appropriate personal protective equipment (safety glasses, hard hat, boots, and protective clothing)



Refer to EQUITONE Material Safety Data Sheets (MSDS) for more information about health and safety, including common hazards associated with working with EQUITONE, and measures to minimise risk.

Panel preparation

Panel cutting

It is recommended that cutting of the panels is carried out off site as much as possible. In situations where this is not possible, on site cutting may be done.

EQUITONE saw blades

EQUITONE saw blades are recommended to be used for cutting the panels. The following table provides the recommended saw speeds with respect to the blade sizes.

Blade Diameter	Blade thickness	Borehole	No. of teeth	Saw Speed (rpm)
160mm	3.2mm	20mm	4	4,000
190mm	3.2mm	20mm	4	3,200
225mm	3.2mm	30mm	6	2,800
300mm	3.2mm	30mm	8	2,000



Cutting procedure

When using portable saws, EQUITONE panels are normally placed face down and the cutting is from the back side. Therefore, it is important that the workbench has a clean and soft material covering it to prevent scratching and marking of the panels.

The blade should be set to extend approximately 5mm below the panel to allow the debris material to escape.



Only one panel should be cut at a time. Do not cut multiple panels together at the same time.

The panel should be held firmly in place to avoid vibration.

Do not cut the panel by allowing the panel to overhang the edge of the work bench as this will damage the edge.

When cutting the panel, it is advisable to place the panel on a solid workbench preferably indoors or under cover. This will reduce the risk of staining from damp/wet weather and makes dust cleaning easier.

Ensure the level of the workbench is set at a comfortable height to allow safe use of the saw and to prevent over stretching by the operatives. Due to the large number of variables, trial cutting on a waste piece of panel should be carried out to determine the optimum saw setting and movement speed of the saw.

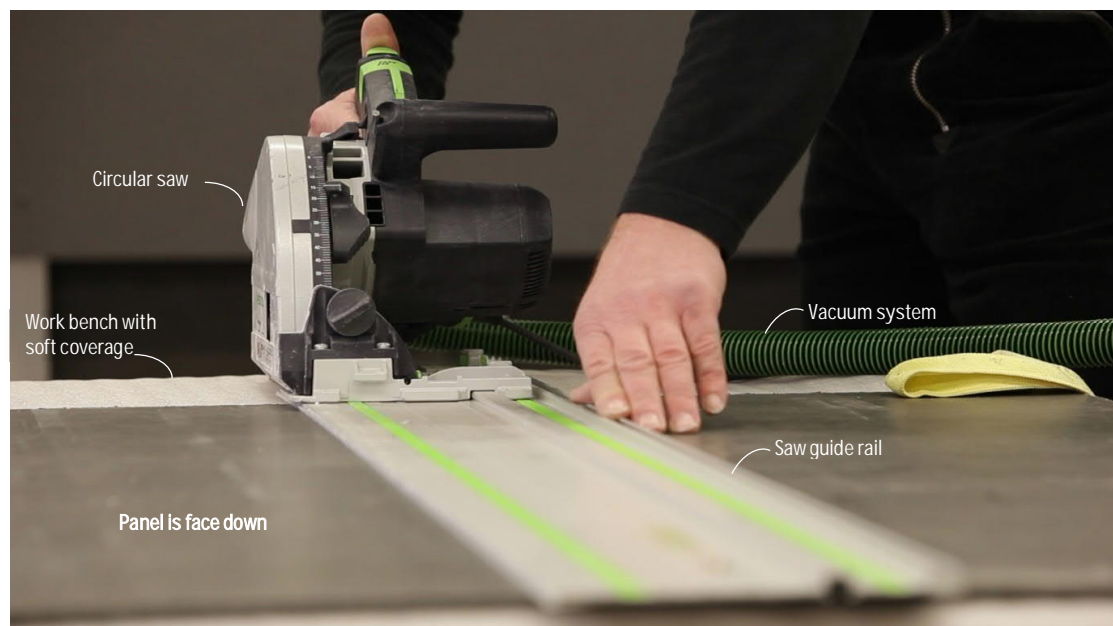

Where untrimmed panels are used, panels must NOT be trimmed before installation.

Refer to Material Information Sheet for trimming procedure.

Untrimmed EQUITONE panels must NOT be used on a façade. Any untrimmed panel used on a façade will render the EQUITONE warranty void. Any claim or complaint relating to the use of untrimmed panels will not be accepted.



Check the quality of EQUITONE panels and components for any visual defects or damage prior to installation. Contact your local EQUITONE organisation for any issues. DO NOT install any panels or components which are either damaged or not aligned with the project requirements and specifications.

Panel preparation



Poorly maintained cutting tools or incorrect saw speed as opposed to blade speed can result in localised heating/ burning of panel edges.

Do not use grinder tools as these usually have a high cutting speed. This produces higher than average pressure on panel edges. Most grinding tools also produce excessive, unwanted dust.

Cutting equipment

Various types of equipment or machinery may be used for cutting EQUITONE panels. These may include portable saw e.g. circular saw, flat-bed horizontal or vertical (wall) saw, and CNC and waterjet machine. The following needs to be noted when considering different types of cutting equipment or machinery.

- Each cutting procedure, equipment or machinery may produce a different edge finish
- Where waterjet is used for panel cutting, panels must be fully dry before they can be stacked or packed
- Panel must be positioned such that cutting is conducted into the panel face to reduce the risk of chipping the edges



Curved cut-outs

For curved cuts or cut-outs –

- place the panel face down (ensure there is a soft coverage on the workbench to protect the panel face),
- drill a hole in the panel at the edge of the intended curved cut-out area,
- ensure jigsaw pendulum function is switched off, and
- insert Bosch T141HM jigsaw blade and proceed to cut.

Due to the length of the blade, space must be provided under the panel to allow the blade to work.



Finishing cut edges

Panel edges should be sanded after cutting them. This reduces the possibility of damage and improves their appearance.

Use 80 grit sandpaper secured to a block of wood, approx. 400 x 100 mm in size. Using a small timber block may result in uneven sanding.

Do not use sanding pads, sponge blocks, or sandpaper without a hard backing, as these may cause curving of the edge finish.

To speed up the sanding process and chamfer the edges at the same time, cut a groove from a block of timber and carefully wrap sandpaper into the groove.

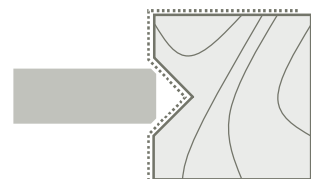

Cleaning after cutting

Immediately after cutting, clean off all dust with a dry, clean microfibre cloth. Keep the cloth free of grit. Only use cloth for cement dust removal. Clean cloth regularly.

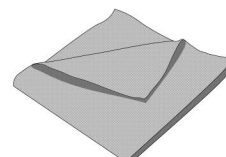

Panel preparation

Panel drilling

All fabrication of EQUITONE panels in terms of cutting to size, drilling the blind holes must be done by competent fabricators or installers in strict accordance with SFS recommendations and guidelines.

As this fixing system is a highly precision solution, accuracy is vital. Therefore, the drilling of the blind holes is best done by using a CNC machine to ensure accuracy of the holes. On site fabrication is also possible with appropriate quality control procedures in place.

Consult the SFS Application Guideline for information on the drilling procedure, checking the hole guidelines and fixings insertion.

Prior to drilling

Before drilling EQUITONE, check the following.



Use only the recommended SFS VHM blind-hole drill bit according to the depth of the anchor/panel thickness



Check for any sign of wear. Do not use a worn-out drill bit



Do not use a drill bit with a point angle

Follow the below procedure for the assembly of the depth locator and VHM drill bit.

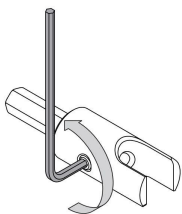

1 Loosen grub screw on depth locator with the supplied Allen key.

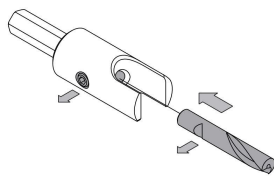

2 Align notch in drill bit to grub screw and insert into the depth locator.

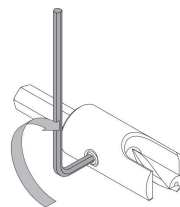

3 Tighten grub screw on depth locator with the supplied Allen key.

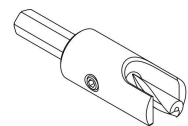

4 Depth locator with VHM drill bit assembled and ready to use.

Every 100 holes, check the accuracy of the depth locator as wear and tear causes the reference dimension (drill depth) to increase. Do not use once it reaches more than 0.5mm.

For 8 mm EQUITONE panel, EQUITONE [lines], and EQUITONE [lunara]

TUF-S	Drill depth (mm)
TUF-S-6x9	5.5

For 12 mm EQUITONE panel

TUF-S	Drill depth (mm)
TUF-S-6x12	8.5

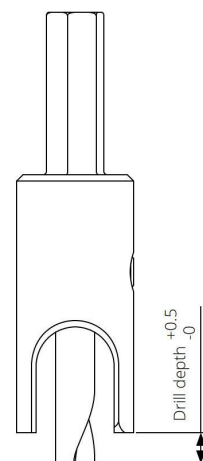

Panel preparation



Ensure the workbench has a clean protective layer to prevent any damage to the panel surface.

Ensure a proper Quality Assurance process is in place to check the size (diameter and depth) of the drilled holes as regularly as required to ensure accuracy and correctness as per SFS application guidelines and requirements.

Do not drill panels on a façade. Drilling must be conducted on a solid workbench.

Drilling procedure

1 Place the panel face down on a workbench with a smooth, hard surface. The panel must be fully supported. Ensure the workbench is covered by a clean protective material to prevent scratching and marking of the panels.

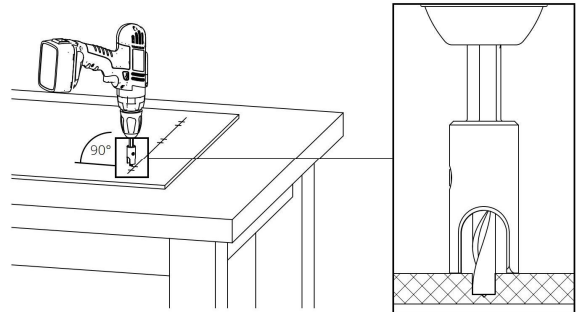

2 Mark the exact location of the blind holes. Use a coloured pencil such as white or red to highlight the hole position especially on grey or dark grey panels. It is possible that a grey pencil mark will be lost in the fibre pattern on the panel's surface.

3 Start drilling the 6 mm diameter blind holes with a hand power drill using the recommended SFS VHM drill bit with depth locator. The holes may also be drilled with a CNC machine using appropriate milling cutter.

The holes must be minimum 5.9 mm and maximum 6.0 mm in diameter. The hole size may be measured and checked with a vernier caliper.

The geometry (diameter and depth) of the drilled hole shall be checked minimum every 100 holes.

During the drilling process, ensure the drill is kept in a right angle and the panel is fully supported on a stable, hard surface.

The panel should be held firmly in place to avoid vibration. Turn off the hammer-action function on the drill as this can cause the drill to move, slip and damage the panel.

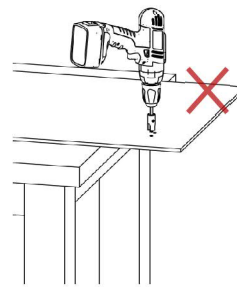

The panel must lie on a hard surface and be fully supported.

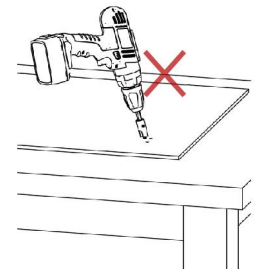

Keep a right angle during the drilling process

4 Remove debris from the drilled holes using compressed air or similar. This is important for the correct application of the SFS TUF-S fixings.

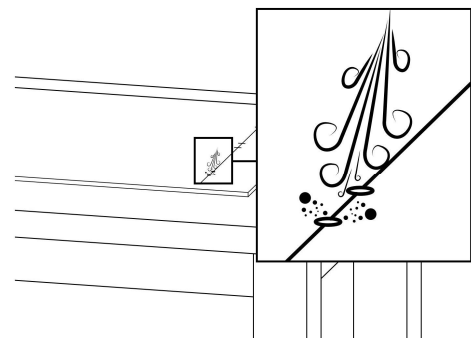

5 Immediately after drilling, clean off all dust with a dry, clean soft brush and microfibre cloth. Keep the brush and cloth dry and free of grit. Do not use a wet brush or cloth as staining may occur. Only use cloth for cement dust removal. Clean brush and cloth regularly.

It is advisable that the drilling process is conducted indoors or under cover. This will reduce the risk of staining because of damp/wet weather.

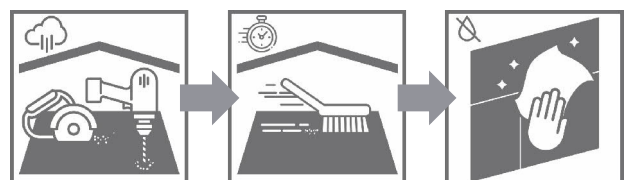

Panel preparation

Panel holes edge distance

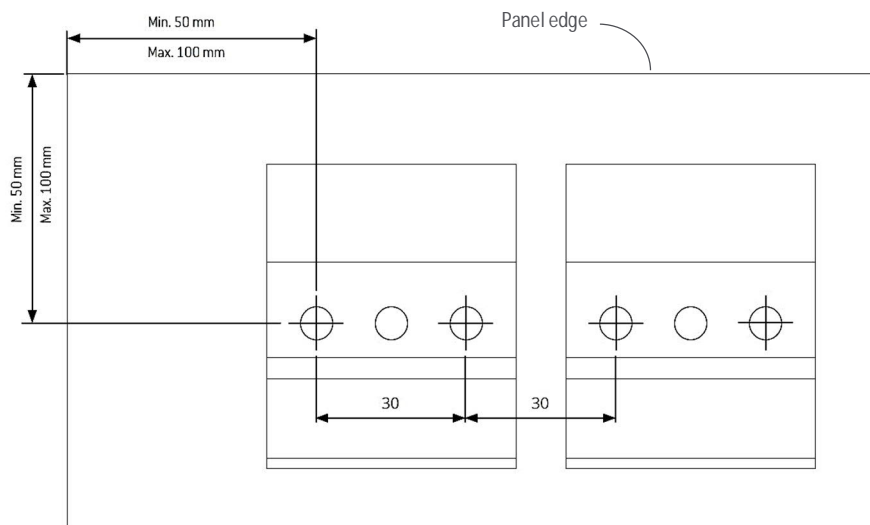

Minimum panel edge distance: 50 mm

Maximum panel edge distance: 100 mm

Minimum distance between SFS TUF-S fixings: 30 mm

Notes:

- All measurements are from the centre of the panel hole
- The recommended panel fixings edge distances provided in this section apply to both wall and soffit/ceiling applications
- The spacing of hangers is determined based on project wind loads but it must not exceed 600 mm, or 400 mm for horizontal (soffit/ceiling) applications



For information about spacing of panel holes or fixings, refer to EQUITONE Span Tables section of this document.

There are always two SFS TUF-S fixings per hanger.

Panel preparation



Ensure the cut edges are sanded and free of any dust before the application of LUKO.

LUKO must be applied with appropriate recommended applicator.

Panel must be positioned flat and face up for LUKO edge treatment.

Any LUKO excess on the panel face must be carefully and thoroughly wiped away. Failure to do so will result in stain that cannot be removed.

Allow for the applied LUKO to dry before manual handling the panel.

For Health and Safety, refer to LUKO Material Safety Data Sheet prior to using LUKO.

Do not re-use a cloth to wipe away any LUKO excess as otherwise it may cause permanent streak marks on the panel face. Use clean microfibre cloth or soft paper towel.



EQUITONE [natura] edge treatment

With semi-transparent coatings like those used on EQUITONE [natura] and [natura] PRO panels, moisture ingress at the panel edges and predrilled holes can become apparent. In wet weather, the edges of the panel and its penetrations can assume a darker shade (picture framing). Picture framing disappears when the moisture evaporates and the panel dries. This phenomenon is a temporary condition that does not affect the physical characteristics of the panel. The length of time it takes for such phenomenon to cease depends on the seasonal weather trends and conditions. Picture framing does not constitute a defect.

To help prevent this phenomenon from occurring, the edges of all factory cut EQUITONE [natura] and EQUITONE [natura] PRO panels are impregnated with LUKO edge sealant at the factory. The edges of EQUITONE [natura] and EQUITONE [natura] PRO panels that have been cut on-site must then also be impregnated with LUKO.

Do not apply LUKO in wet conditions or after the panel has been fixed.

Edge treatment procedure Cut, sand, clean and LUKO.



After sanding the edges of the panel, remove all dust from the edges.

1



Apply the LUKO between +5°C and 25°C.
Treat one panel at a time.



Simply pour only enough LUKO into the clean tray that can be used within 30 mins.
Do not pour any leftover LUKO back into the container.



Use the sponge applicator by dipping into the liquid and removing any excess.
Do not move the applicator over the surface of the panel as any drips will be seen and cannot be removed once dried.



Starting at one side of the panel, angle the applicator away from the face of the panel.
Simply run the applicator along the edge.
Ensure full coverage of the edge.
Repeat the process if necessary.



Immediately wipe away any excess that appears on the panel surface. Failure to do so will result in a stain that cannot be removed.
Use a different colour cloth or recyclable paper towels – Do not use micro fibre cloth that was used to remove the dust.
Do not reuse a cloth as it may cause permanent streak marks and staining.
Allow the applied LUKO to dry before manual handling of the panel.

Panel installation

Tools and accessories

General tools and accessories required for panel installation are as follows. The following list is by no means exhaustive.

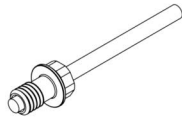

SFS TUF-S fixings



NV3 levelling (adjustable) hangers

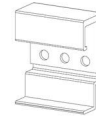

NV3 Static hangers

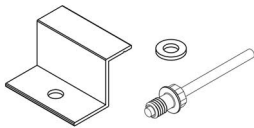

NV3 soffit/wall fixing clip



NV3 horizontal carrier rail



NV3 horizontal express joint backing trim (baffle)



NV3 vertical express joint backing trim

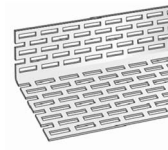

Perforated profile



Drill



GESIPA Powerbird Pro battery operated rivet gun



Metal snips for cutting perforated profile, baffle, and flashings



Clean microfibre cloth for dust removal



Leveling tools



Shims & packers as required



Knife



Measuring tools



Pencils for marking



This list does not include the components of vertical support frame to which the horizontal carrier rails are fixed, nor does it include the fixings of the support frame.

Panel installation



Ensure the panel drilling and hanger installation are conducted in strict accordance with SFS and NVELOPE application guidelines and recommendations.

Under no circumstances must any installed hangers be used as a lifting lug or handle for carrying or moving of the panels. The hangers and their fixings have not been designed for this purpose. Doing so may overstress the hangers and their connections to the panel.



Check the quality of EQUITONE panels and components for any visual defects or damage prior to installation. Contact your local EQUITONE organisation for any issues. DO NOT install any panels or components which are either damaged or not aligned with the project requirements and specifications.

Installation of hangers

1

Place the panel face down on a smooth and stable workbench with a clean surface and a suitable protection to prevent any damage to panel face.

Ensure all dust and debris is removed from all panel holes using compressed air or similar. The panel must lie on a hard surface and be fully supported.

2

Position the NV3 hanger over the panel drillholes and insert the TUF-S fixings in both drillholes.

Remember that the top row hangers are levelling or adjustable type.

Put the rivet gun on the fixings and hold it perpendicular to panel surface. Do not apply force.

Recommended rivet gun is GESIPA Powerbird Pro with nose piece 17/36 or 17/40.

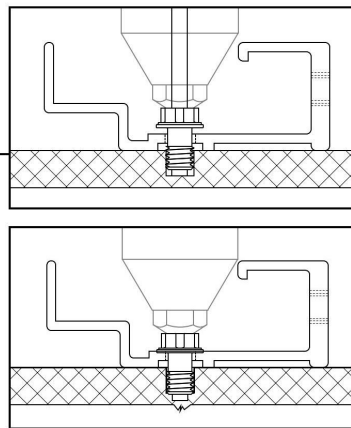
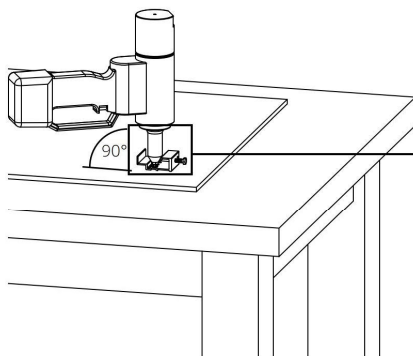

Before setting the TUF-S fixings, there can be a small gap between the TUF-S head and the hanger. This is normal, and once the TUF-S rivet is set the gap will be closed.

Do not apply force to the TUF-S before setting as this may cause damage to the panel face.

3

Set the TUF-S fixings by removing the mandrel. Apply positive gentle pressure to the rivet gun towards the panel during mandrel removal.

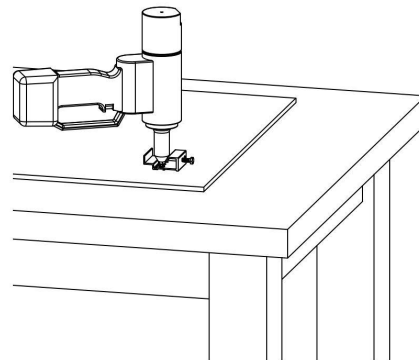
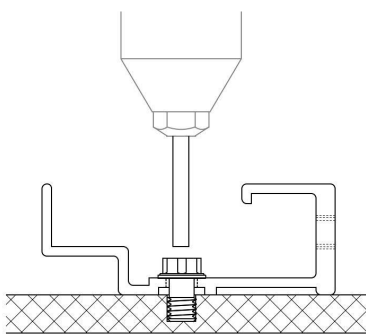

Panel installation

Installation of vertical rails

Cladding support frame must be installed as per its manufacturer's guidelines, the project requirements, structural design and engineering, and the applicable standards and regulations. Refer to the project engineering information and design for the fixings and spacing details of the vertical rails.

Aluminium bracketry framing system

This type of support frame generally comprises vertical rails, to which the horizontal carrier rails are fixed, and brackets connecting the vertical rails to the substructure. NVELOPE offers a range of aluminium bracketry systems commonly used with EQUITONE.

Refer to the supplier of NVELOPE support frames for general guidance and span tables for typical applications.



Zed or top hat (Omega) vertical rails

Where a bracketry framing system is not required, other types of vertical rail system such as Zed and top hat framing profiles may be used.

Support frame thermal movement

Allowance for any expansion and contraction of the metal supporting frame needs to be considered in the overall design of the system. Adequate allowance for the thermal movement of the support frame needs to be made, particularly, at its connection to the substrate.

Where an aluminium bracketry system is used, the brackets usually include both round (fixed) and elongated (gliding) holes for the purpose of allowance for thermal movement of the vertical rail.

Where the fixings are applied to the round holes it forms a fixed connection (fixed points) while applying the fixings only to the elongated holes forms the gliding connections (gliding points) allowing for movement. Ensure that the connection between the brackets and the rails provides enough expansion and contraction. The fixings must be centred in the slot.

The fixed-point bracket shall be located at the mid height of the vertical rail. The other brackets need to be gliding points to allow for movement. All fixed points must be at same level around the façade.

The principle of fixing and gliding points is a good one and where possible is recommended for all metal supporting frames. This is particularly relevant in ecologies that experience climatic extremes and large variations in temperature.

Where Zed or top hat (Omega) framing profiles are used, allowance for thermal movements may be made by predrilling the fixing holes within the profile prior to installation. The drillholes are adequately larger than the size of the fixings for the profile to freely expand and contract as required.

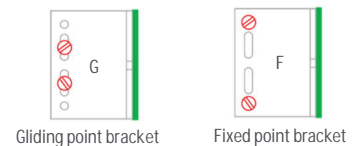

For further information about NVELOPE components and product specifications, refer to the supplier of NVELOPE systems.

The application of NVELOPE systems shall be in accordance with its supplier's recommendations and guidelines.

Panel installation

Support frame length & joints

It is recommended to limit the length of the vertical rails to 3 m (maximum panel height).

A minimum gap of 20 mm shall be considered between two vertical rails.

EQUITONE panel must not bridge this gap or any control/movement joints while fixed to both adjacent profiles.

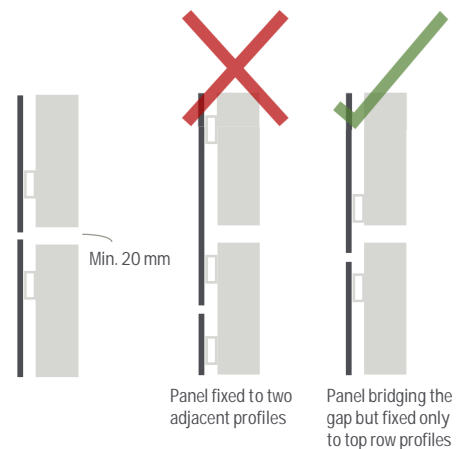

Installation of horizontal rails

NV3 horizontal carrier rails shall be fixed to the vertical rails in accordance with engineering details and manufacturer's recommendations.

The length of the rails shall be limited to 3 m.

To allow for thermal movement over the horizontal rail, it must be predrilled with 7mm (screw diameter plus 1.5mm) drill bit for fixing to the vertical rails.

The horizontal rail is usually fixed with two stainless steel fixings to each vertical rail.

For predrilling, mark the centre of the vertical rails on the horizontal rail to determine the location of the drill holes.

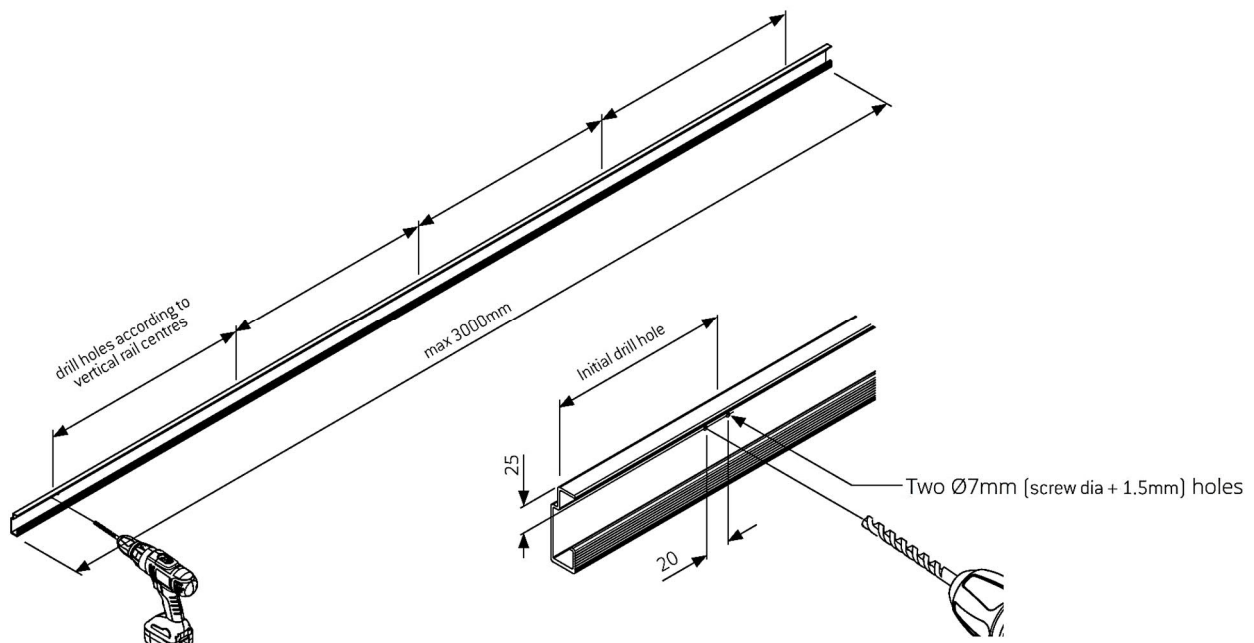

Panel installation

Ensure horizontal rails are installed perfectly level. Maximum cantilever of the horizontal rails shall be limited to 300 mm or less depending on the project engineering requirements.

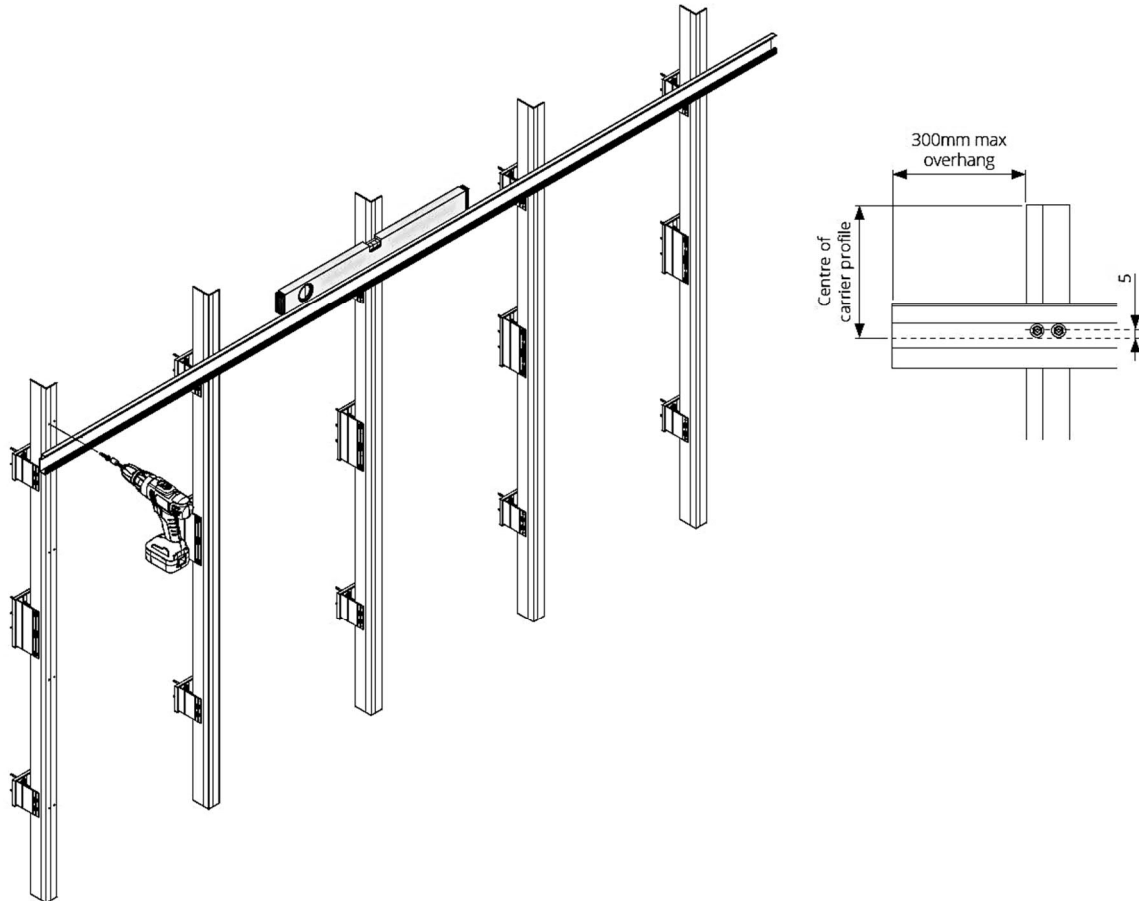

Ensure the horizontal rails are correctly spaced according to the spacing of the hangers fixed to the panels. The spacing of the hangers and horizontal rails shall be calculated with respect to the project wind loading and engineering. Refer to the 'Engineering' section of this document for the spacing of the hangers and horizontal rails with respect to project wind loading.

Ensure a minimum 20 mm gap between any adjacent installed rails.

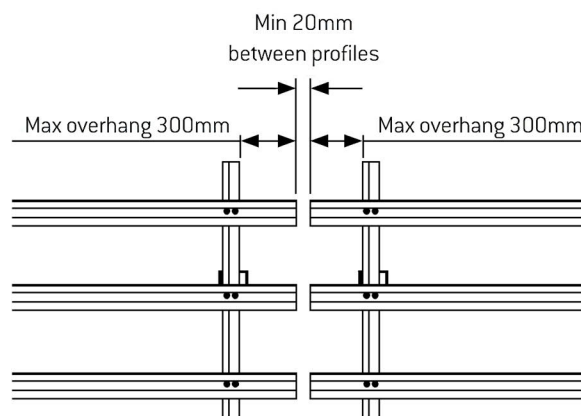

Panel installation

Panel joints

Depending on the project design requirements and weather barrier type, the panel joints may be open or closed.

Open joints

By leaving the joints open, the likelihood of dirt spoiling the facade reduces as the joint remains clean. The open joints also function as additional ventilation openings.

Consider the colour choice of the support frame, any external insulation, and/or weather barrier as these may be visible through the open joints. These components may need to be concealed using appropriate black profiles, paint or tape.

A rigid weather barrier is required for an open joint façade.

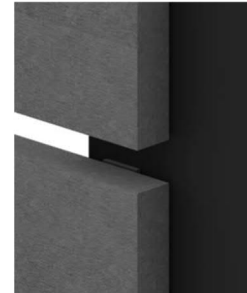

Closed joints

In a closed joint design, the horizontal joints are closed with NV3 aluminium horizontal express joint backing trims (baffle), and the vertical joints are closed with NV3 vertical express joint backing trims.

The trims should have adequate corrosion resistance appropriate to the project location.

By using the joint trims, most of the water is prevented from entering the cavity. In some buildings it is advisable to have closed joints, such as the low areas of public or educational buildings. The joint trims will prevent debris from being deposited behind the panels. In the case of kindergartens, the trims will prevent small fingers from getting stuck in the joints.

Where a flexible (pliable) weather barrier is used, panel joints are required to be closed.

Note: Caulking or sealing the joints with sealant is not recommended as the applied sealant may deteriorate in time and cause staining and maintenance issues.



Typical joint width

Many years of practice have shown that the optimum width of the joints between large panels is 10mm. This also offers the installer a reasonable level of tolerance when setting out the frame and fitting the panel.

- The minimum recommended joint width: 8mm
- The maximum recommended joint width: 12mm

Where smaller or larger joint width is required, consult with your local Etex Exteriors ANZ technical department.

Panel installation



Installation of horizontal express joint trim (baffle)

1

Apply a suitable double-sided tape to the back of EQUITONE panel where baffle is going to be placed. Ensure the application of the tape is in strict accordance with its manufacturer's or supplier's guidelines and recommendations.

The recommended double-sided tape is tesa® 62936. Follow tesa® 62936 installation guidelines for the correct application of the tape. Tesa Adhesion Prompter 60150 or 60153 is recommended by Tesa when using tesa® 62936. Apply adequate pressure on the tape to ensure sufficient adhesion and avoid any air bubbles under the tape.

Place the tape close to the panel edge such that it will not be visible from the panel joint.

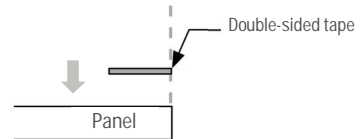
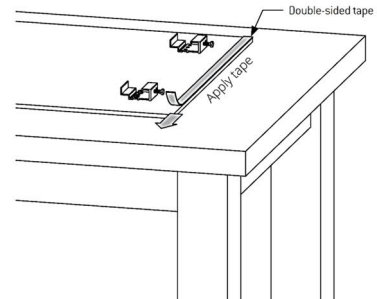

2

Cut the baffle approximately 4 mm shorter than the panel width so that it does not cross and become visible at the vertical panel joints.

Ensure the baffle is clean and free of any dust, grease, oil, moisture, and other contaminants before the application. Adhesion promoter is recommended by Tesa to ensure proper adhesion to the baffle.

Remove the backing of the double-sided tape.

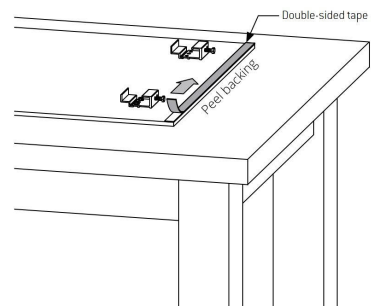
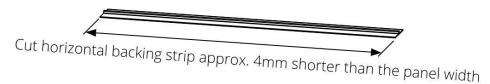

3

Stick the baffle in place. Ensure the baffle is placed in the right position with respect to the panel joint width.

Due to immediate bonding, repositioning of the tape or baffle is not recommended. Removing the baffle is only possible shortly after its application to the tape. Once the baffle has been removed, the tape cannot be used again and needs to be replaced with a new one.

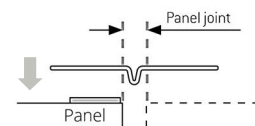
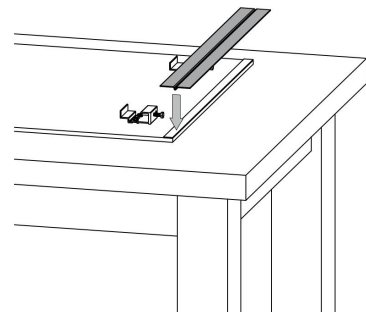

Panel installation

Installation of vertical express joint trim

1

Cut the NV3 vertical express joint backing trim to the required length (max. 3.1 m) and apply the EPDM foam gaskets continuously as shown below.

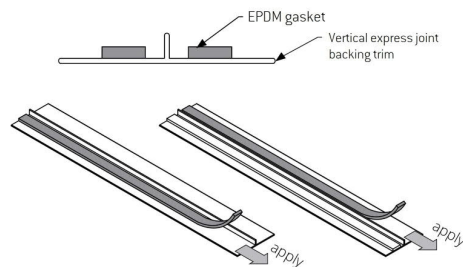

2

Ensure the NV3 horizontal carrier rails are correctly installed. Position the NV3 vertical express joint backing trim on the horizontal carrier rails. Pre-drill holes for riveting and fix to the carrier rails.

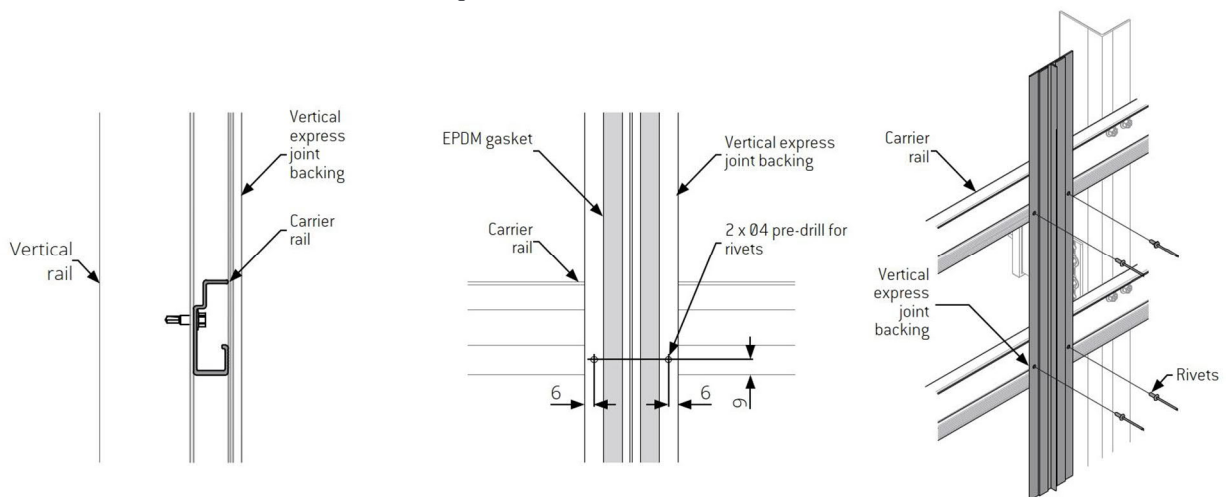

3

Follow the below procedure for joining the NV3 vertical express joint backing trim. Same applies over any control or movement joints.

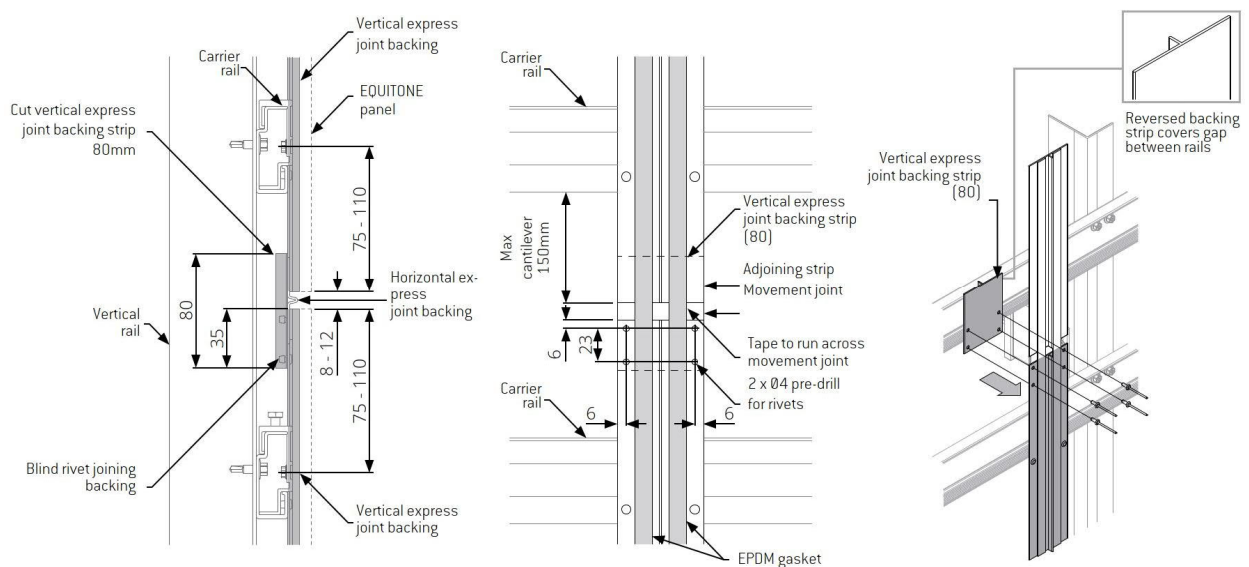

Panel installation

Panel Installation

Installation sequence

The panels are usually mounted from the bottom upwards to allow access to the top hangers for any required adjustments and levelling.

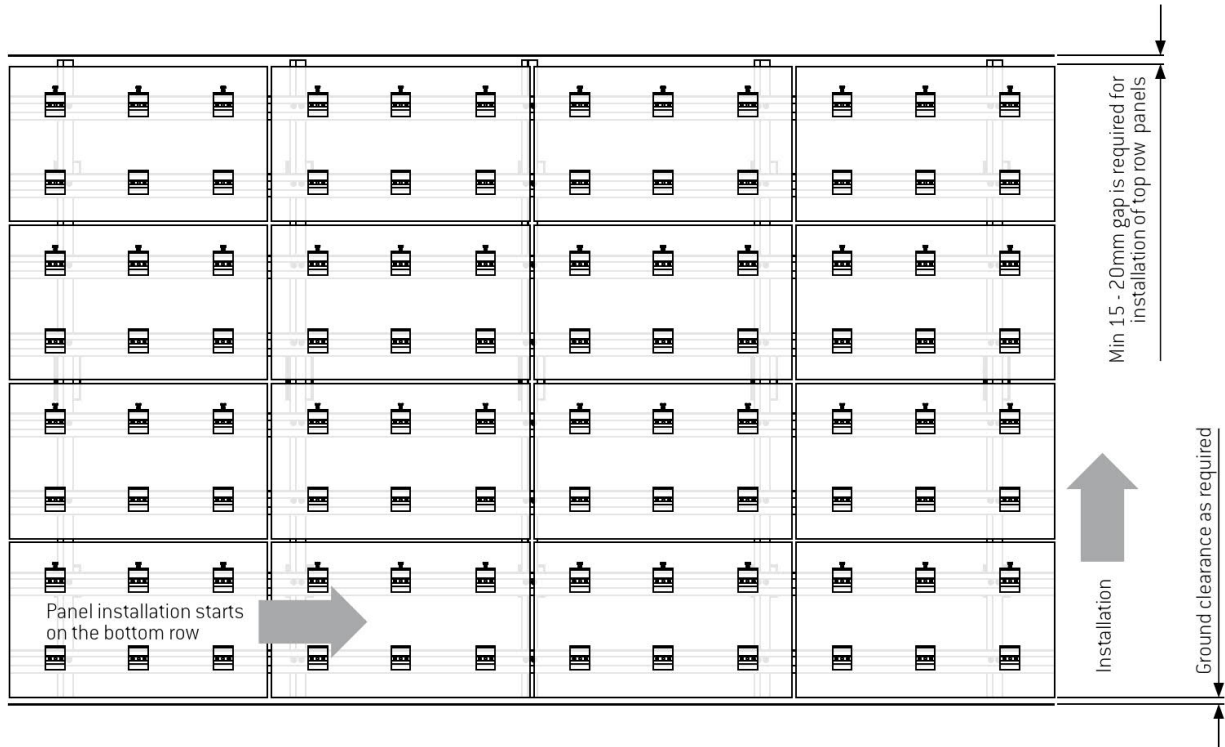

Installation procedure

1

Set the adjustment bolt of the adjustable hangers to halfway. This will allow up and down adjustment to level the panel.

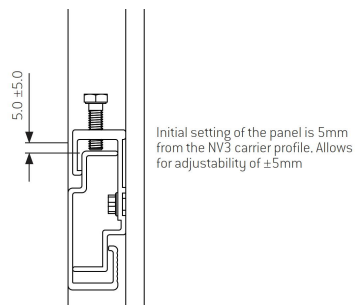

2

Lift the panel in and over the horizontal rails ensuring the interlock of the hangers line up with the horizontal rail.

Gently lower the panel down so it interlocks. Adjust to correct position and level in place.

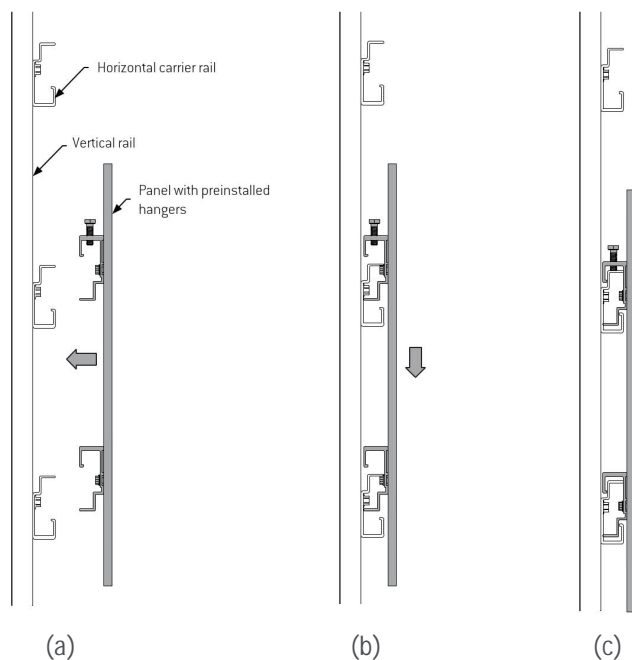

Panel installation

The installation procedure is the same for closed express joint façade.

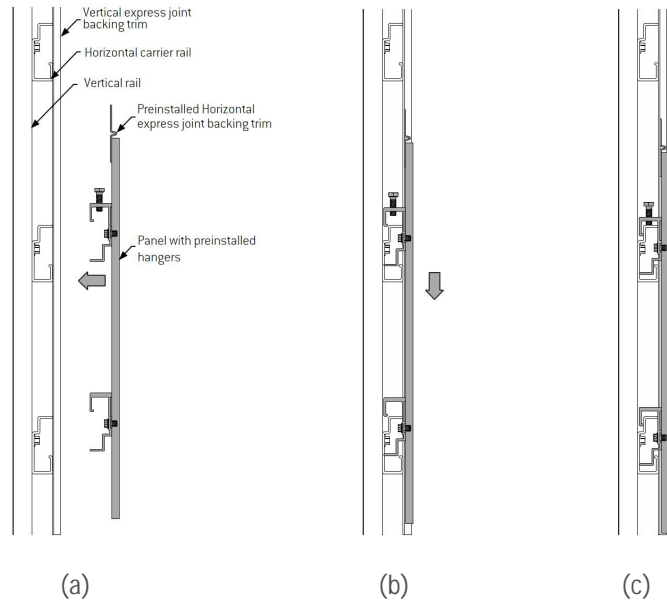

3
Adjust and level the panel.

- a) Start with adjusting the outer hangers
- b) Once the outer hangers are adjusted and panel is level, continue with adjusting the remaining, intermediate, hangers to the same level so that the panel weight is distributed evenly across all hangers

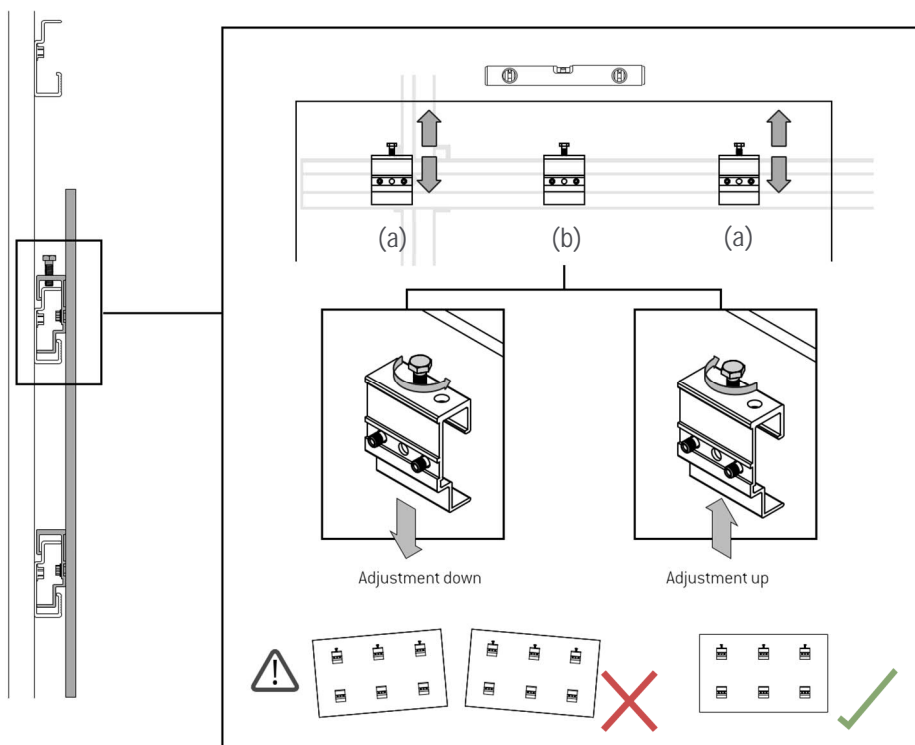

4
Once the panel is level, apply one of the methods described in the next section to prevent the panel moving sideways in time.

Panel installation

Methods for preventing panel sidewise movement

Option 1: Applying a locking screw after panel installation

(Applies to both wall and soffit/ceiling applications)

This panel fixing method is used where individual panel removability is not required after installation or in service. This means for any panel removal or replacement, first any panels installed above will need to be removed to get to the panel(s) requiring removal or replacement.

For this method, once the panel is positioned in place and levelled and all the top hangers are adjusted, a stainless steel screw is applied to one of the hangers located –

- at the top row of the panel hangers, and
- at or close to centreline of the panel.

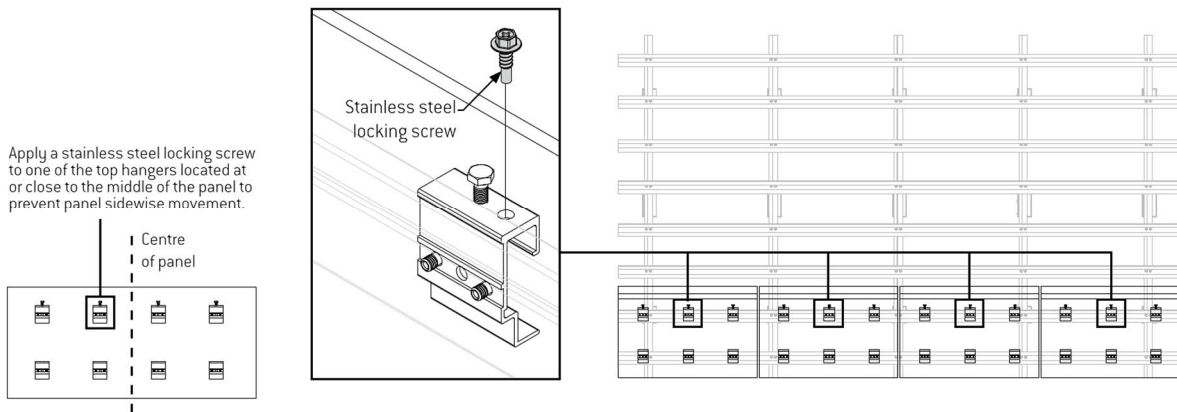

Where panel has only two lines of hangers, the locking screw is either applied always to the left or always to the right top hanger. It is important to be consistent across the façade. Do not overtighten the locking screw; it should only be hand tightened.

Option 2: Prefixing of locking angles

(Only applies to wall applications)

This panel fixing method is used where individual panel removability (removal or replacement of panels without requiring removal of any panels located above the panel requiring removal or replacement) is important after installation and over the course of the panels' service life.

This method is also used where Option 1 is not possible, for example, where there is no room to apply the locking screw in place e.g., at the interface with a slab or the like where there is no access to apply a locking screw after panel installation.

In this case, prior to the installation of the panel, two suitable aluminium angles are fixed to the horizontal carrier rail where the panel' top hanger located at or close to the centreline of the panel will be located once the panel is installed.

To do this, first mark the location of one of the top hangers located at or close to the middle of the panel on the horizontal rail, and then fix the angles with suitable stainless steel screws to the rail such that the hanger falls in between these installed angles once the panel is positioned in place.

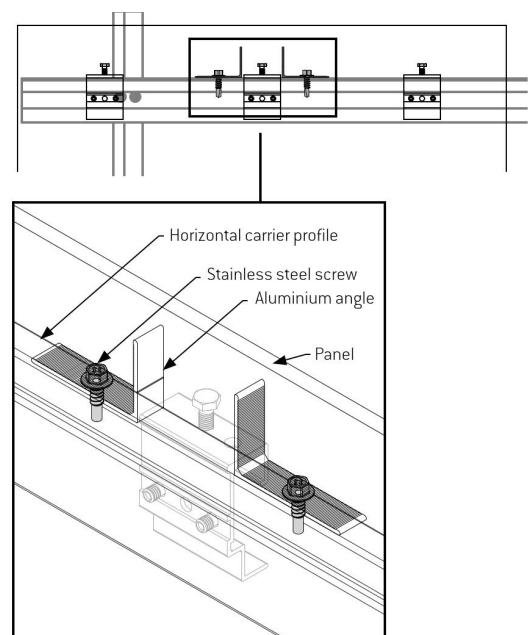

Panel installation

Like Option 1, where panel has only two lines of hangers, the locking screws or angles are either applied always to the left or right top hanger. It is important to be consistent across the façade in that either all the right side or all the left side top hangers on all panels.

Option3: Preinstalled NV3 Fix clip

(Applies for both wall and soffit/ceiling applications)

This panel fixing method is used mostly in soffit/ceiling applications where either access to apply the locking screw will be tight after panel installation or individual panel removability is required. For this method, the NV3 Fix clip will need to be fixed to the back of the panel with a SFS fixings prior to installation as per below.

- Place the panel face down on a smooth and stable workbench or table. Ensure the table surface is clean and has a suitable protection to prevent any damage to panel face.
- Mark the location of the clip at the back of the panel; note that the clip will need to be aligned with a support frame profile to which the clip will be fixed once the panel is installed.
- Mark the location of the clip's hole on the panel.
- Drill a blind hole using correct SFS drill bit in accordance with SFS application guidelines (the same procedure as that of drilling the panel holes for hangers applies).
- Place the clip over the hole and apply the washer and SFS fixings; ensure the hole is clean and free of any debris before inserting the SFS fixings. Fix the clip in place.

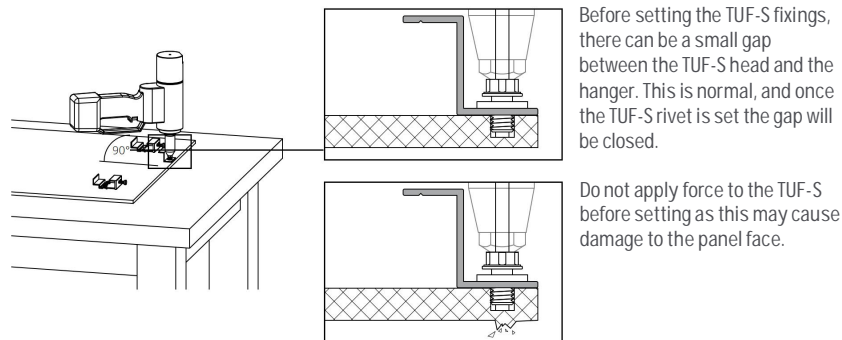

The panel with the preinstalled clip and hangers can now be installed. Once the panel is installed, the clip can be rotated to align with the support frame rail and be fixed with suitable stainless steel screws to the rail.

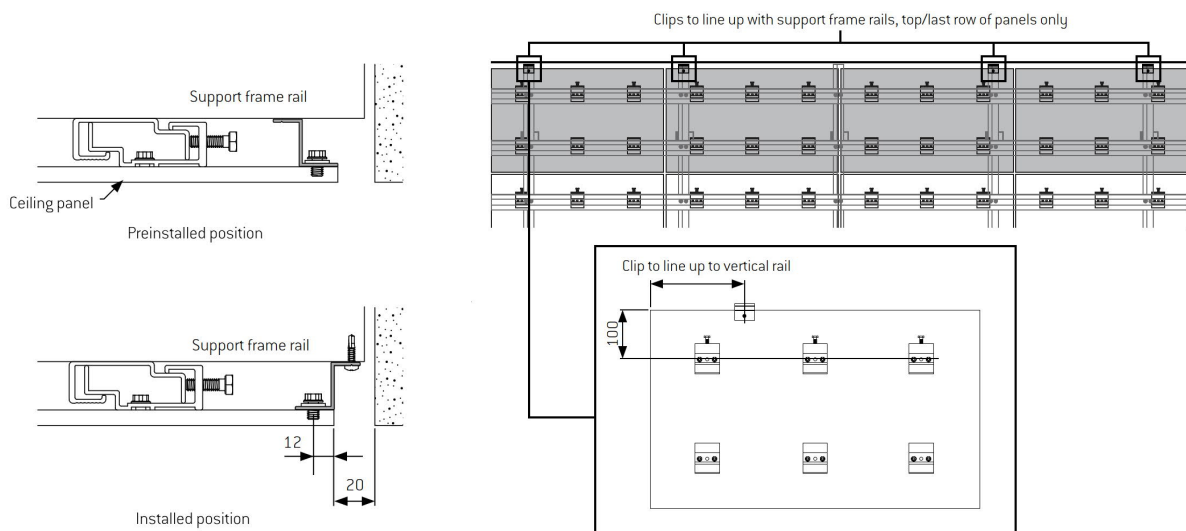

Panel installation



Protection of installed panels

General notes

A sequence or method of placing the EQUITONE panels on the facade must be put in place to ensure the risk of damage to the panels is minimised.

EQUITONE panels are a finished façade product and are generally the last major cladding material to be fitted. Due care is therefore required.

Care and attention are required if other trades (e.g. painting or rendering) need to follow on after the panel is fitted. The panels must then be protected. Stains from coloured renders cannot be removed, and replacement of the panels is the only remedy.

Corflute sheets or the like are generally used to protect the panels. These sheets are generally temporarily fixed to the support frame located at vertical panel joints. Do not use tape as it may leave residue on and stain the panels when it is removed.

Note: Avoid using tape on the panel finish as adhesive residue may be difficult or even impossible to remove, depending on the tape type and how long it remains on the panel. While low-tack tape poses less risk, it can still damage the panel finish when exposed to sunlight or leave residue on the surface.

Coordination with other trades

Proper coordination between the façade contractor installing EQUITONE panels and other trades with works around EQUITONE panels is crucial in ensuring all these trades are fully aware of the allowance for ventilation requirements.

For instance, the installation of capping/flashing over EQUITONE panels sometimes is carried out by a different trade than the façade contractor. In this case, lack of coordination between the two trades may result in the required air outlets for EQUITONE being closed and blocked with an incorrect installation of these elements.

Another example is when the paving and landscaping works block the air inlet of EQUITONE at the bottom of the façade, or where window sills/flashings hinder or block the ventilation at the interface with window heads and sills due to incorrect detailing or installation of these components.

Typical construction details

Refer to 'Construction details – EQUITONE with concealed fixings' document for a comprehensive set of independently assessed and certified EQUITONE typical construction details which must be read in conjunction with this Design and Installation Guide.

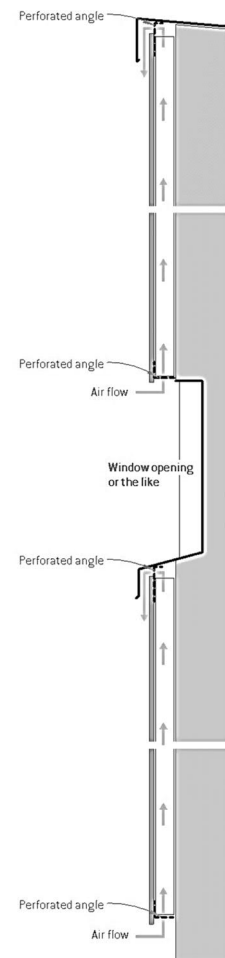

Engineering

General information

The information provided in this section is based on the information received from an independent consultant who has been engaged to provide their opinion, engineering design and report based on independently conducted laboratory testing, technical data sheets of EQUITONE materials and components, relevant standards, and/or their experience.

It is the responsibility of project consultants and engineers to ensure the provided information in this document is appropriate to the project and intended application. The overall performance of an installed EQUITONE façade or wall assembly is the responsibility of the project designer, architect, engineers and consultants, builder and/or certifier. The project wind category and maximum wind pressure applied to the cladding or façade shall be determined by the project engineer. Maximum deflection of support frame must be limited to $\text{Span}/250$.

The maximum spacing of NV3 hangers is 600 mm or less depending on the applied wind loading. The maximum 600 mm spacing also applies to internal applications.

Wall application

Multiple spans fixing arrangement

When panel is fixed with three or more rows and columns of NV3 hangers, the fixing arrangement is considered to be multiple spans and the following span tables may be used to determine the hangers spacing.

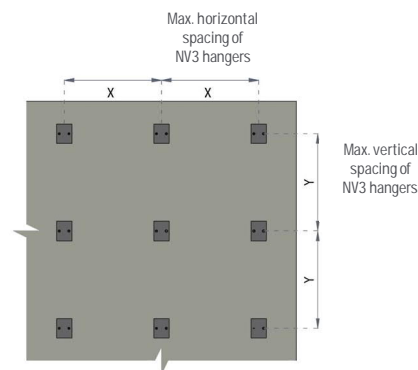

Span tables for EQUITONE [tectiva], [lines] and [lunara] with multiple span fixings arrangement on a wall application

Table 1 – Maximum NV3 hanger spacing – Class 1 & 10 buildings
Multiple spans fixing arrangement – Wall applications
EQUITONE [tectiva], [lines] and [lunara]

AS 4055 wind category	General zone	
	Maximum horizontal spacing (X) of NV3 hangers (mm)	Maximum vertical spacing (Y) of NV3 hangers (mm)
N1	600	600
N2	600	600
N3	600	600
N4	600	450
N5	550	250
N6	400	250
Corner zone		
N1	600	600
N2	600	550
N3	600	250
N4	400	250
N5	250	250
N6	200	200

Span tables for EQUITONE [tectiva], [lines] and [lunara] with multiple span fixings arrangement on a wall application (continued)

Table 2 – Maximum ultimate wind pressure applied to EQUITONE with respect to maximum NV3 hanger spacing – All building classes
Multiple spans fixing arrangement – Wall applications
EQUITONE [tectiva], [lines] and [lunara]

Vertical spacing (Y) of cladding fixings (mm)	Horizontal spacing (X) of cladding fixings (mm)								
	600	550	500	450	400	350	300	250	200
	Max AS/NZS1170.2 ultimate wind pressure (kPa)								
600	1.19	1.29	1.42	1.56	1.65	1.76	1.87	1.99	2.10
550	1.29	1.41	1.55	1.70	1.80	1.92	2.04	2.17	2.29
500	1.42	1.55	1.71	1.87	1.98	2.11	2.24	2.38	2.52
450	1.56	1.70	1.87	2.08	2.20	2.34	2.49	2.65	2.80
400	1.65	1.80	1.98	2.20	2.48	2.64	2.80	2.98	3.15
350	1.76	1.92	2.11	2.34	2.64	3.01	3.20	3.40	3.60
300	1.87	2.04	2.24	2.49	2.80	3.20	3.74	3.97	4.19
250	1.99	2.17	2.38	2.65	2.98	3.40	3.97	4.76	5.03
200	2.10	2.29	2.52	2.80	3.15	3.60	4.19	5.03	6.29

Table 3 – Maximum NV3 hanger spacing with respect to maximum ultimate wind pressure applied to EQUITONE – All building classes
Multiple spans fixing arrangement – Wall applications
EQUITONE [tectiva], [lines] and [lunara]

Ultimate wind pressure (kPa)	Maximum horizontal spacing (X) of panel fixings (mm)	Maximum vertical spacing (Y) of panel fixings (mm)
1.00	600	600
1.25	600	550
1.50	600	450
1.75	600	350
2.00	600	200
2.25	550	200
2.50	500	200
2.75	450	200
3.00	400	200
3.50	350	200
4.00	300	200
5.00	250	200

Notes for Tables 1 to 3

- Wind loads have been determined for external pressures only; it is assumed that internal pressures are resisted by appropriately designed internal linings.
- Wind loads have been determined in accordance with AS/NZS 1170.2.
- General zone: Areas greater than 1200 mm from an external building corner. Corner zone: Areas less than 1200 mm from an external building corner.
- Maximum panel cantilever must not exceed 100 mm.
- Cladding framing deflection is limited to Span/250 with the serviceability wind load equal to 68% of the ULS wind load.
- The values apply only to non-cyclonic wind regions.
- The values are based on two SFS TUF-S-6 fixings per hanger.

Engineering

Span tables for EQUITONE [natura], [pictura], and [inspira] with multiple span fixings arrangement on a wall application

Table 4 – Maximum NV3 hanger spacing – Class 1 & 10 buildings
Multiple spans fixing arrangement – Wall applications
EQUITONE [natura], [pictura], & [inspira]

AS 4055 wind category	General zone	
	Maximum horizontal spacing (X) of NV3 hangers (mm)	Maximum vertical spacing (Y) of NV3 hangers (mm)
N1	600	600
N2	600	600
N3	600	450
N4	600	300
N5	550	200
N6	400	200
Corner zone		
N1	600	500
N2	600	350
N3	600	200
N4	400	200
N5	250	250
N6	200	200

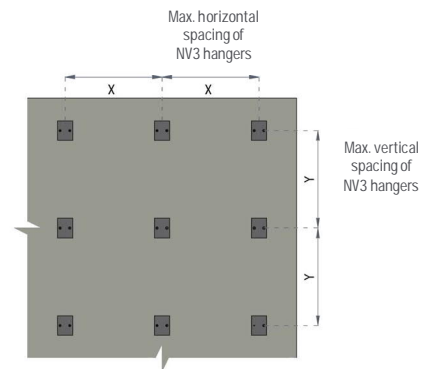

Table 5 – Maximum ultimate wind pressure applied to EQUITONE with respect to maximum NV3 hanger spacing – All building classes
Multiple spans fixing arrangement – Wall applications
EQUITONE [natura], [pictura], & [inspira]

Vertical spacing (Y) of cladding fixings (mm)	Horizontal spacing (X) of cladding fixings (mm)								
	600	550	500	450	400	350	300	250	200
Max AS/NZS1170.2 ultimate wind pressure (kPa)									
600	0.81	0.88	0.97	1.07	1.21	1.38	1.61	1.87	1.97
550	0.88	0.96	1.05	1.17	1.32	1.51	1.76	2.04	2.15
500	0.97	1.05	1.16	1.29	1.45	1.66	1.93	2.24	2.37
450	1.07	1.17	1.29	1.43	1.61	1.84	2.15	2.49	2.63
400	1.21	1.32	1.45	1.61	1.81	2.07	2.42	2.80	2.96
350	1.38	1.51	1.66	1.84	2.07	2.37	2.76	3.20	3.38
300	1.61	1.76	1.93	2.15	2.42	2.76	3.22	3.73	3.95
250	1.87	2.04	2.24	2.49	2.80	3.20	3.73	4.48	4.73
200	1.97	2.15	2.37	2.63	2.96	3.38	3.95	4.73	5.92

Table 6 – Maximum NV3 hanger spacing with respect to maximum ultimate wind pressure applied to EQUITONE – All building classes
Multiple spans fixing arrangement – Wall applications
EQUITONE [natura], [pictura], & [inspira]

Ultimate wind pressure (kPa)	Maximum horizontal spacing (X) of panel fixings (mm)	Maximum vertical spacing (Y) of panel fixings (mm)
1.00	600	450
1.25	600	350
1.50	600	300
1.75	600	250
2.00	550	250
2.25	500	200
2.50	450	200
2.75	400	250
3.00	350	250
3.50	300	250
4.00	250	250
5.00	200	200

Notes for Tables 4 to 6

- Wind loads have been determined for external pressures only; it is assumed that internal pressures are resisted by appropriately designed internal linings.
- Wind loads have been determined in accordance with AS/NZS 1170.2.
- General zone: Areas greater than 1200 mm from an external building corner. Corner zone: Areas less than 1200 mm from an external building corner.
- Maximum panel cantilever must not exceed 100 mm.
- Cladding framing deflection is limited to Span/250 with the serviceability wind load equal to 68% of the ULS wind load.
- The values apply only to non-cyclonic wind regions.
- The values are based on two SFS TUF-S-6 fixings per hanger.

Single span fixing arrangement

When panel is fixed with two rows or columns of NV3 hangers, the fixing arrangement is considered to be single span and the following span tables may be used to determine the hangers spacing.

Span tables for **EQUITONE [tectiva]**, **[lincs]** and **[lunara]** with single span fixings arrangement on a wall application

Table 7 – Maximum NV3 hanger spacing – Class 1 & 10 buildings

Single span fixing arrangement – Wall applications
EQUITONE [tectiva], [lincs] and [lunara]

AS 4055 wind category	General zone	
	Maximum horizontal spacing (X) of NV3 hangers (mm)	Maximum vertical spacing (Y) of NV3 hangers (mm)
N1	600	600
N2	600	600
N3	600	600
N4	600	400
N5	600	200
N6	450	200
Corner zone		
N1	600	600
N2	600	500
N3	600	250
N4	450	200
N5	300	200
N6	200	200

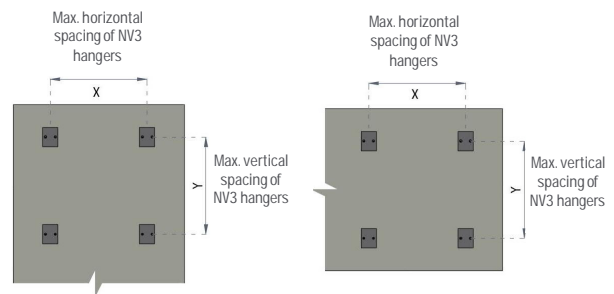

Table 8 – Maximum ultimate wind pressure applied to EQUITONE with respect to maximum NV3 hanger spacing – All building classes

Single span fixing arrangement – Wall applications
EQUITONE [tectiva], [lincs] and [lunara]

Vertical spacing (Y) of cladding fixings (mm)	Horizontal spacing (X) of cladding fixings (mm)									
	600	550	500	450	400	350	300	250	200	
Max AS/NZS1170.2 ultimate wind pressure (kPa)										
600	1.11	1.21	1.33	1.48	1.67	1.91	2.22	2.37	2.37	
550	1.19	1.29	1.42	1.58	1.78	2.03	2.37	2.82	2.82	
500	1.27	1.39	1.52	1.69	1.91	2.18	2.54	3.05	3.41	
450	1.37	1.49	1.64	1.82	2.05	2.35	2.74	3.28	4.10	
400	1.48	1.62	1.78	1.98	2.22	2.54	2.96	3.56	4.45	
350	1.62	1.76	1.94	2.16	2.43	2.77	3.23	3.88	4.85	
300	1.78	1.94	2.13	2.37	2.67	3.05	3.56	4.27	5.34	
250	1.98	2.16	2.37	2.63	2.96	3.39	3.95	4.74	5.93	
200	2.22	2.43	2.67	2.96	3.33	3.81	4.45	5.34	6.67	

Table 9 – Maximum NV3 hanger spacing with respect to maximum ultimate wind pressure applied to EQUITONE – All building classes

Single span fixing arrangement – Wall applications
EQUITONE [tectiva], [lincs] and [lunara]

Ultimate wind pressure (kPa)	Maximum horizontal spacing (X) of panel fixings (mm)	Maximum vertical spacing (Y) of panel fixings (mm)
1.00	600	600
1.25	600	500
1.50	600	350
1.75	600	300
2.00	600	200
2.25	550	200
2.50	500	200
2.75	450	200
3.00	400	200
3.50	350	200
4.00	300	200
5.00	250	200

Notes for Tables 7 to 9

- Wind loads have been determined for external pressures only; it is assumed that internal pressures are resisted by appropriately designed internal linings.
- Wind loads have been determined in accordance with AS/NZS 1170.2.
- General zone: Areas greater than 1200 mm from an external building corner. Corner zone: Areas less than 1200 mm from an external building corner.
- Maximum panel cantilever must not exceed 100 mm.
- Cladding framing deflection is limited to Span/250 with the serviceability wind load equal to 68% of the ULS wind load.
- The values apply only to non-cyclonic wind regions.
- The values are based on two SFS TUF-S-6 fixings per hanger.

Engineering

Span tables for EQUITONE [natura], [pictura], and [inspira] with single span fixings arrangement on a wall application

Table 10 – Maximum NV3 hanger spacing – Class 1 & 10 buildings
Single span fixing arrangement – Wall applications
EQUITONE [natura], [pictura], & [inspira]

AS 4055 wind category	General zone	
	Maximum horizontal spacing (X) of NV3 hangers (mm)	Maximum vertical spacing (Y) of NV3 hangers (mm)
N1	600	600
N2	600	600
N3	600	600
N4	600	350
N5	550	200
N6	400	200
Corner zone		
N1	600	600
N2	600	450
N3	600	200
N4	400	200
N5	250	250
N6	200	200

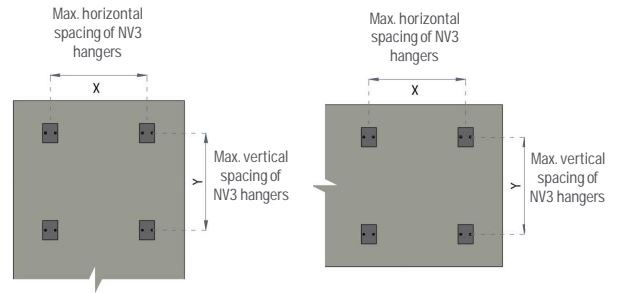

Table 11 – Maximum ultimate wind pressure applied to EQUITONE with respect to maximum NV3 hanger spacing – All building classes
Single span fixing arrangement – Wall applications
EQUITONE [natura], [pictura], & [inspira]

Vertical spacing (Y) of cladding fixings (mm)	Horizontal spacing (X) of cladding fixings (mm)									
	600	550	500	450	400	350	300	250	200	
Max AS/NZS1170.2 ultimate wind pressure (kPa)										
600	1.05	1.14	1.25	1.39	1.57	1.79	2.09	2.51	2.53	
550	1.12	1.22	1.34	1.49	1.67	1.91	2.23	2.68	3.01	
500	1.19	1.30	1.43	1.59	1.79	2.05	2.39	2.87	3.58	
450	1.29	1.40	1.54	1.72	1.93	2.21	2.57	3.09	3.86	
400	1.39	1.52	1.67	1.86	2.09	2.39	2.79	3.35	4.18	
350	1.52	1.66	1.83	2.03	2.28	2.61	3.04	3.65	4.56	
300	1.67	1.83	2.01	2.23	2.51	2.87	3.35	4.02	5.02	
250	1.86	2.03	2.23	2.48	2.79	3.19	3.72	4.46	5.58	
200	2.09	2.28	2.51	2.79	3.14	3.58	4.18	5.02	6.27	

Table 12 – Maximum NV3 hanger spacing with respect to maximum ultimate wind pressure applied to EQUITONE – All building classes
Single span fixing arrangement – Wall applications
EQUITONE [natura], [pictura], & [inspira]

Ultimate wind pressure (kPa)	Maximum horizontal spacing (X) of panel fixings (mm)	Maximum vertical spacing (Y) of panel fixings (mm)
1.00	600	600
1.25	600	450
1.50	600	350
1.75	600	250
2.00	600	200
2.25	550	200
2.50	500	200
2.75	450	200
3.00	400	200
3.50	350	200
4.00	300	200
5.00	250	200

Notes for Tables 10 to 12

- Wind loads have been determined for external pressures only; it is assumed that internal pressures are resisted by appropriately designed internal linings.
- Wind loads have been determined in accordance with AS/NZS 1170.2.
- General zone: Areas greater than 1200 mm from an external building corner. Corner zone: Areas less than 1200 mm from an external building corner.
- Maximum panel cantilever must not exceed 100 mm.
- Cladding framing deflection is limited to Span/250 with the serviceability wind load equal to 68% of the ULS wind load.
- The values apply only to non-cyclonic wind regions.
- The values are based on two SFS TUF-S-6 fixings per hanger.

Ceiling/soffit application

Multiple spans fixing arrangement

When panel is fixed with three or more rows and columns of NV3 hangers, the fixing arrangement is considered to be multiple spans and the following span tables may be used to determine the hangers spacing.

Span tables for EQUITONE [tectiva], [lines] and [lunara] with multiple span fixings arrangement on a soffit application

Table 13 – Maximum NV3 hanger spacing – Class 1 & 10 buildings
Multiple spans fixing arrangement – Ceiling/soffit applications
EQUITONE [tectiva], [lines] and [lunara]

AS 4055 wind category	General zone	
	Maximum horizontal spacing (X) of NV3 hangers (mm)	Maximum vertical spacing (Y) of NV3 hangers (mm)
N1	400	400
N2	400	400
N3	400	400
N4	400	550
N5	400	400
N6	400	200
Corner zone		
N1	400	400
N2	400	400
N3	400	400
N4	400	200
N5	250	250
N6	200	200

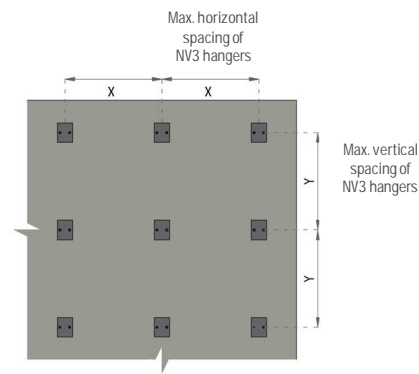

Maximum spacing between panel fixings/hangers for soffit or ceiling applications is 400 mm or less depending on wind loading.

Refer to the supplier of NVELOPE framing systems for the generic design and span tables of the cladding framing system.

The design of cladding support frame is the responsibility of the project façade or structural engineer.

The connection of the support frame to substructure should be designed by the project façade or structural engineer.

Table 14 – Maximum ultimate wind pressure applied to EQUITONE with respect to maximum NV3 hanger spacing – All building classes
Multiple spans fixing arrangement – Ceiling/soffit applications
EQUITONE [tectiva], [lines] and [lunara]

Vertical spacing (Y) of cladding fixings (mm)	Horizontal spacing (X) of cladding fixings (mm)				
	400	350	300	250	200
Max AS/NZS1170.2 ultimate wind pressure (kPa)					
400	2.26	2.42	2.58	2.76	2.93
350	2.42	2.79	2.98	3.18	3.38
300	2.58	2.98	3.52	3.75	3.98
250	2.76	3.18	3.75	4.55	4.81
200	2.93	3.38	3.98	4.81	6.07

Table 15 – Maximum NV3 hanger spacing with respect to maximum ultimate wind pressure applied to EQUITONE – All building classes
Multiple spans fixing arrangement – Ceiling/soffit applications
EQUITONE [tectiva], [lines] and [lunara]

Ultimate wind pressure (kPa)	Maximum horizontal spacing (X) of panel fixings (mm)	Maximum vertical spacing (Y) of panel fixings (mm)
1.00	400	400
1.25	400	400
1.50	400	400
1.75	400	400
2.00	400	400
2.25	400	400
2.50	400	300
2.75	400	250
3.00	350	250
3.50	300	300
4.00	250	250
5.00	200	200

Notes for Tables 13 to 15

- The tables do not apply to 12mm panel.
- Wind loads have been determined for external pressures only; it is assumed that internal pressures are resisted by appropriately designed internal linings.
- Wind loads have been determined in accordance with AS/NZS 1170.2, and is assumed to be equal to that for adjacent wall cladding.
- General zone: Areas greater than 1200 mm from an external building corner. Corner zone: Areas less than 1200 mm from an external building corner.
- Maximum panel cantilever must not exceed 100 mm.
- Cladding framing deflection is limited to Span/250 with the serviceability wind load equal to 68% of the ULS wind load.
- The values apply only to non-cyclonic wind regions.
- The values are based on two SFS TUF-S-6 fixings per hanger.

Engineering

Span tables for EQUITONE [natura], [pictura], and [inspira] with multiple span fixings arrangement on a soffit application

Table 16 – Maximum NV3 hanger spacing – Class 1 & 10 buildings
Multiple spans fixing arrangement – Ceiling/soffit applications
EQUITONE [natura], [pictura], & [Inspira]

AS 4055 wind category	General zone	
	Maximum horizontal spacing (X) of NV3 hangers (mm)	Maximum vertical spacing (Y) of NV3 hangers (mm)
N1	400	400
N2	400	400
N3	400	400
N4	400	350
N5	400	300
N6	350	250
Corner zone		
N1	400	400
N2	400	400
N3	400	300
N4	350	250
N5	250	200
N6	-	-

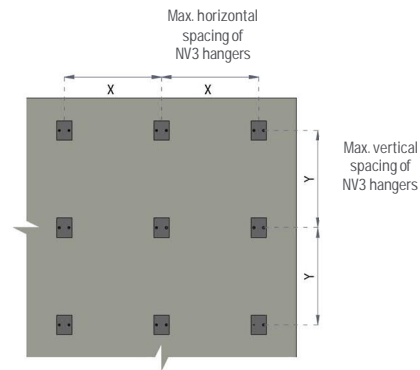

Table 17 – Maximum ultimate wind pressure applied to EQUITONE with respect to maximum NV3 hanger spacing – All building classes
Multiple spans fixing arrangement – Ceiling/soffit applications
EQUITONE [natura], [pictura], & [Inspira]

Vertical spacing (Y) of cladding fixings (mm)	Horizontal spacing (X) of cladding fixings (mm)				
	400	350	300	250	200
Max AS/NZS1170.2 ultimate wind pressure (kPa)					
400	1.59	1.85	2.20	2.58	2.74
350	1.85	2.15	2.54	2.98	3.16
300	2.20	2.54	3.00	3.52	3.73
250	2.58	2.98	3.52	4.26	4.52
200	2.74	3.16	3.73	4.52	5.70

Table 18 – Maximum NV3 hanger spacing with respect to maximum ultimate wind pressure applied to EQUITONE – All building classes
Multiple spans fixing arrangement – Ceiling/soffit applications
EQUITONE [natura], [pictura], & [Inspira]

Ultimate wind pressure (kPa)	Maximum horizontal spacing (X) of panel fixings (mm)	Maximum vertical spacing (Y) of panel fixings (mm)
1.00	400	400
1.25	400	400
1.50	400	400
1.75	400	350
2.00	400	300
2.25	400	250
2.50	400	250
2.75	350	250
3.00	350	200
3.50	300	250
4.00	250	250
5.00	200	200

Notes for Tables 16 to 18

- The tables do not apply to 12mm panel.
- Wind loads have been determined for external pressures only; it is assumed that internal pressures are resisted by appropriately designed internal linings.
- Wind loads have been determined in accordance with AS/NZS 1170.2, and is assumed to be equal to that for adjacent wall cladding.
- General zone: Areas greater than 1200 mm from an external building corner. Corner zone: Areas less than 1200 mm from an external building corner.
- Maximum panel cantilever must not exceed 100 mm.
- Cladding framing deflection is limited to Span/250 with the serviceability wind load equal to 68% of the ULS wind load.
- The values apply only to non-cyclonic wind regions.
- The values are based on two SFS TUF-S-6 fixings per hanger.

Single span fixing arrangement

When panel is fixed with two rows or columns of NV3 hangers, the fixing arrangement is considered to be single span and the following span tables may be used to determine the hangers spacing.

Span tables for EQUITONE [tectiva], [lines] and [lunara] with single span fixings arrangement on a soffit application

Table 19 – Maximum NV3 hanger spacing – Class 1 & 10 buildings
Single span fixing arrangement – Ceiling/soffit applications
EQUITONE [tectiva], [lines] and [lunara]

AS 4055 wind category	General zone	
	Maximum horizontal spacing (X) of NV3 hangers (mm)	Maximum vertical spacing (Y) of NV3 hangers (mm)
N1	400	400
N2	400	400
N3	400	400
N4	400	400
N5	400	350
N6	400	200
Corner zone		
N1	400	400
N2	400	400
N3	400	400
N4	400	200
N5	250	250
N6	200	200

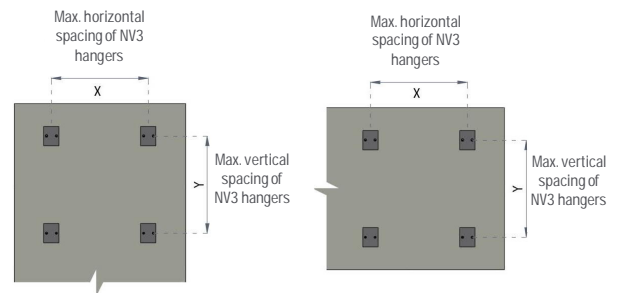

Table 20 – Maximum ultimate wind pressure applied to EQUITONE with respect to maximum NV3 hanger spacing – All building classes
Single span fixing arrangement – Ceiling/soffit applications
EQUITONE [tectiva], [lines] and [lunara]

Vertical spacing (Y) of cladding fixings (mm)	Horizontal spacing (X) of cladding fixings (mm)				
	400	350	300	250	200
Max AS/NZS1170.2 ultimate wind pressure (kPa)					
400	2.00	2.32	2.75	3.34	4.23
350	2.21	2.55	3.01	3.66	4.63
300	2.45	2.83	3.34	4.05	5.12
250	2.75	3.17	3.73	4.52	5.71
200	3.12	3.59	4.23	5.12	6.45

Table 21 – Maximum NV3 hanger spacing with respect to maximum ultimate wind pressure applied to EQUITONE – All building classes
Single span fixing arrangement – Ceiling/soffit applications
EQUITONE [tectiva], [lines] and [lunara]

Ultimate wind pressure (kPa)	Maximum horizontal spacing (X) of panel fixings (mm)	Maximum vertical spacing (Y) of panel fixings (mm)
1.00	400	400
1.25	400	400
1.50	400	400
1.75	400	400
2.00	400	400
2.25	400	300
2.50	400	250
2.75	400	250
3.00	400	200
3.50	350	200
4.00	300	200
5.00	250	200

Notes for Tables 19 to 21

- Wind loads have been determined for external pressures only; it is assumed that internal pressures are resisted by appropriately designed internal linings.
- Wind loads have been determined in accordance with AS/NZS 1170.2, and is assumed to be equal to that for adjacent wall cladding.
- General zone: Areas greater than 1200 mm from an external building corner. Corner zone: Areas less than 1200 mm from an external building corner.
- Maximum panel cantilever must not exceed 100 mm.
- Cladding framing deflection is limited to Span/250 with the serviceability wind load equal to 68% of the ULS wind load.
- The values apply only to non-cyclonic wind regions.
- The values are based on two SFS TUF-S-6 fixings per hanger.

Engineering

Span tables for EQUITONE [natura], [pictura], and [inspira] with single span fixings arrangement on a soffit application

Table 22 – Maximum NV3 hanger spacing – Class 1 & 10 buildings
Single span fixing arrangement – Ceiling/soffit applications
EQUITONE [natura], [pictura], & [inspira]

AS 4055 wind category	General zone	
	Maximum horizontal spacing (X) of NV3 hangers (mm)	Maximum vertical spacing (Y) of NV3 hangers (mm)
N1	400	400
N2	400	400
N3	400	400
N4	400	400
N5	400	300
N6	400	200
Corner zone		
N1	400	400
N2	400	400
N3	400	350
N4	400	200
N5	250	200
N6	200	200

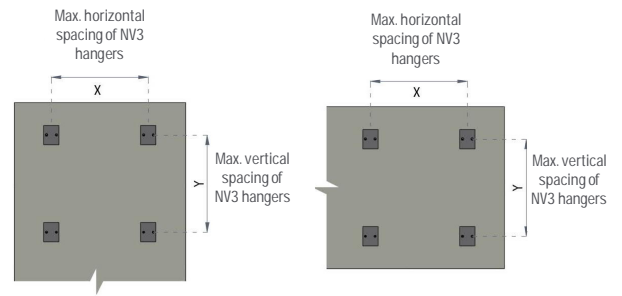

Table 23 – Maximum ultimate wind pressure applied to EQUITONE with respect to maximum NV3 hanger spacing – All building classes
Single span fixing arrangement – Ceiling/soffit applications
EQUITONE [natura], [pictura], & [inspira]

Vertical spacing (Y) of cladding fixings (mm)	Horizontal spacing (X) of cladding fixings (mm)				
	400	350	300	250	200
Max AS/NZS1170.2 ultimate wind pressure (kPa)					
400	1.87	2.17	2.57	3.13	3.96
350	2.06	2.39	2.82	3.43	4.34
300	2.29	2.65	3.13	3.80	4.80
250	2.57	2.97	3.50	4.24	5.36
200	2.92	3.37	3.96	4.80	6.05

Table 24 – Maximum NV3 hanger spacing with respect to maximum ultimate wind pressure applied to EQUITONE – All building classes
Single span fixing arrangement – Ceiling/soffit applications
EQUITONE [natura], [pictura], & [inspira]

Ultimate wind pressure (kPa)	Maximum horizontal spacing (X) of panel fixings (mm)	Maximum vertical spacing (Y) of panel fixings (mm)
1.00	400	400
1.25	400	400
1.50	400	400
1.75	400	400
2.00	400	350
2.25	400	300
2.50	400	250
2.75	400	200
3.00	350	200
3.50	300	200
4.00	250	250
5.00	200	200

Notes for Tables 22 to 24

- Wind loads have been determined for external pressures only; it is assumed that internal pressures are resisted by appropriately designed internal linings.
- Wind loads have been determined in accordance with AS/NZS 1170.2, and is assumed to be equal to that for adjacent wall cladding.
- General zone: Areas greater than 1200 mm from an external building corner. Corner zone: Areas less than 1200 mm from an external building corner.
- Maximum panel cantilever must not exceed 100 mm.
- Cladding framing deflection is limited to Span/250 with the serviceability wind load equal to 68% of the ULS wind load.
- The values apply only to non-cyclonic wind regions.
- The values are based on two SFS TUF-S-6 fixings per hanger.

Design considerations

Application

EQUITONE may be used internally or externally on all types of buildings provided that the façade is designed according to applicable loads including project wind loading, project location, general guidelines provided in this document, applicable standards and regulations, and the Building Code of Australia.

For any project specific design and/or applications outside of the typical applications covered in this and other EQUITONE technical documents, seek further advice from your local EQUITONE technical team.

Limitations

There are limitations for use of EQUITONE panels on non-vertical external applications. Refer to Etex Exteriors ANZ technical department for more information and project specific advice.

EQUITONE has been designed for ventilated façade systems. For non-ventilated external applications like encased curtain wall type, refer to Etex Exteriors ANZ technical department for limitations and recommendations.

EQUITONE is not recommended for the following applications:

- Internal applications exposed to direct moisture e.g. wet areas
- Contact with standing snow or ice
- Exposure to temperatures exceeding 80°C

Façade layout

While the design of the supporting frame is calculated around the wind loading, the facade will be subjected to the actual panel layout desired by the Architect. The panel layout can have a significant influence on the number of horizontal profiles needed.

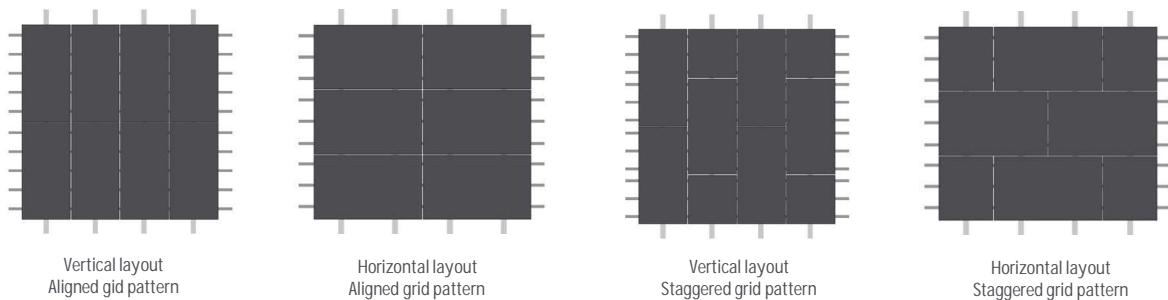

Regardless of the panel layout type, it is important to have a break in both the cladding and support frame at any control or movement joints, e.g. generally under the slabs or where there is a deflection, movement, or control joint. See 'Movement & control joints' section.

Design considerations

Economic panel size

EQUITONE panels can be cut to any size and offer the architect and designer wide design freedom. When designing, the following information is aimed at providing the specifier with guidance on the most economic material usage from standard sheets. Sizes greater than half the maximum manufacturing lengths become progressively less economical in ratio to the distance downwards from full length to half length as indicated on the following charts.

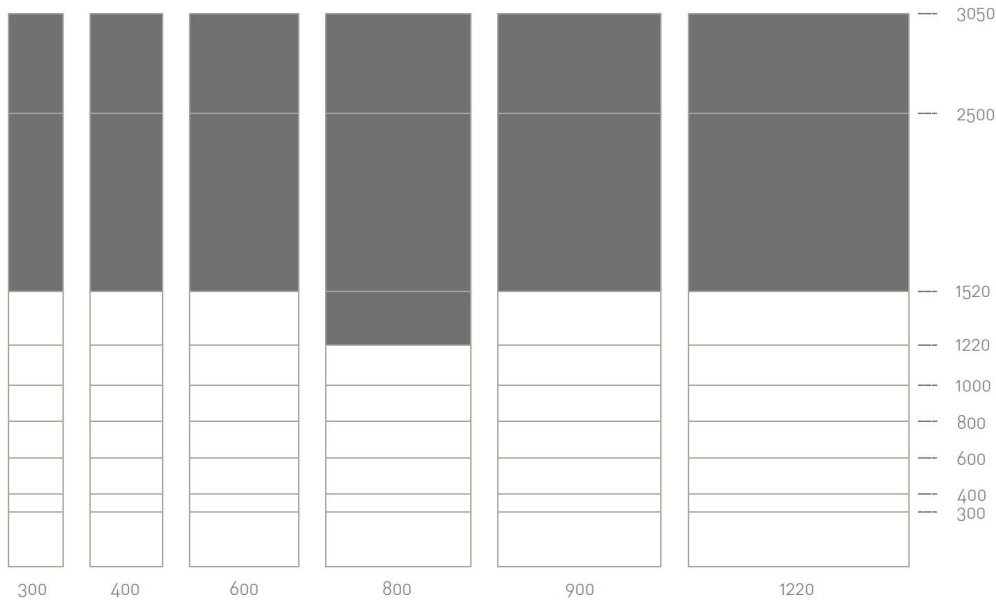

The shaded areas indicate the most uneconomic modules cut from a standard sheet size (based on 1220mm x 3050mm sheet).

Movement & control joints

Cladding and its support framing must not bridge over a building movement or control joint while fixed to both sides of the joint. Adequate separation in both cladding and its support framing is required at any movement or control joint and the like.

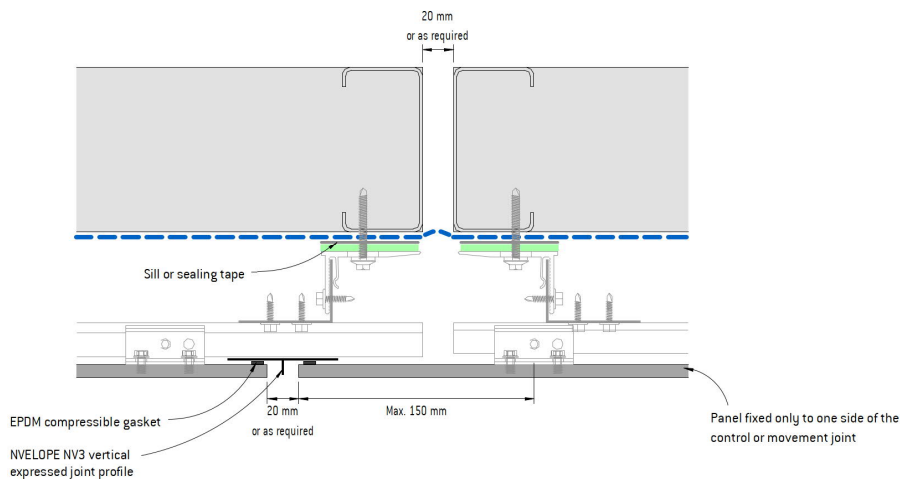

Design considerations

Generally, at the slab levels where differential movement of the slab and/or frame shrinkage may be a concern, a horizontal control joint is considered and an inter storey flashing is incorporated as required.

The support frame must not bridge the movement or deflection joint while fixed to substructure or framing located above and below the movement or deflection joint unless allowance for the required movement is made e.g. through a bracketry system with elongated holes in its brackets or connection with the substructure or framing.

The inter storey flashing also assists with effective moisture management of the façade by compartmentalisation of the cavity by floor level. The following image shows an example of horizontal control joint or inter storey detail. For full construction details in relation to both general horizontal and vertical control joints interfaces, refer to 'Construction details – EQUITONE with concealed fixings'.

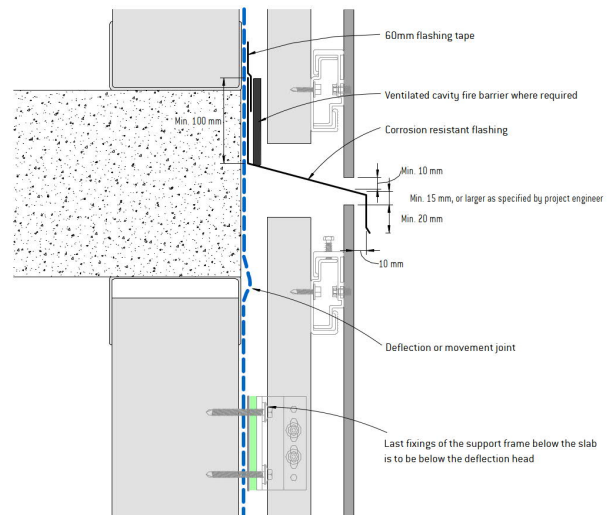

Cavity

The cavity is a primary feature of a ventilated facade. It is designed to act as a pressure cushion to prevent water from reaching the backing wall. By ventilating the cavity, moisture that arises from water passing the panel, moisture migrating from the inner surface of the wall or the action of condensation will be removed either by evaporation, or simply running down the back of the panel and drain out of the cavity.

Cavity width

It is generally considered that the minimum cavity width should be at least 40 mm immediately behind the back of the panel with concealed fixings. Approximately 20 mm of this width is covered with the NV3 horizontal rails, leaving a gap of approximately 20 mm for ventilation and drainage. However, this is only suitable for a cladding height of up to 3 m and low rise buildings with open joints. As the facade gets higher, the cavity needs to increase in width. The general recommended minimum cavity width is 50 mm.

The type of joint used between the panels will also have an influence on the cavity width. Open horizontal joints will allow more air movement than baffled joints and therefore a wider cavity is considered with baffled joints.

Generally, the recommended minimum cavity widths with closed (baffled) joints and NV3 horizontal rails are as follows:

EQUITONE cladding height or distance between air inlet and outlet (m)	< 10	< 20	< 50	< 75	< 100	< 125
Minimum cavity width (mm)	50	60	70	80	95	120

NOTE: On renovation projects, when designing the width of the cavity, it is important to make allowance for tolerance. Building irregularities, especially uneven backing walls, external insulation, and/or weather barrier, must never compromise the effective width of the cavity required for a clear air flow behind the panels. This is critical when a horizontal support frame is incorporated into the cavity space. Please note that the minimum cavity width which has been adopted for the purpose of weather proofing assessment and testing of EQUITONE façade systems is 35 mm.

Design considerations

Curved facade

EQUITONE panels are flat. However, it is possible to ease them around a curved facade. Note that the orientation of the panel is also critical. A horizontal panel bends easier than one placed vertically. The minimum radius that an 8mm EQUITONE panel can be fixed to a curved facade is 12 m.

When the panels are applied on a curved facade, the joint will not be square but is angled to accommodate the curve. Visually it is better to keep the outer edge of the joint gap at 10mm and allow the inner edge to be less than 10mm. If not, depending on the curve, the joint could be more than 12mm wide. To allow this to happen it is important that the setting out of the support frame reflects this. The opposite applies to an inner curving facade.

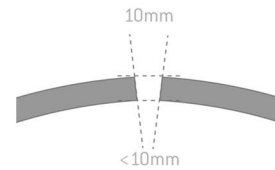

For smaller radii, the panel may be segmented into a series of narrow strips. Generally, two intermediate top hats are used in lieu of a wide joint top hat at vertical joints to prevent overstressing of the panel. The following is a typical vertical joint detail. For more details, refer to 'Construction details – EQUITONE with concealed fixings' document.

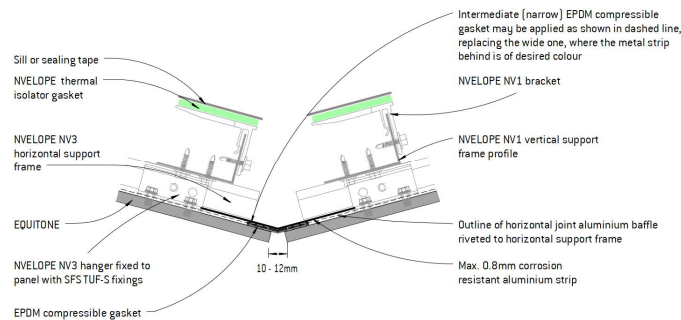

Weatherproofing

System compliance

EQUITONE facade systems have been assessed for the purpose of compliance with the NCC 2022 F3P1 and H2P2 for the following scope:

- With flexible weather barrier (sarking):
 - Serviceability wind pressure: $\pm 2\text{KPa}$
 - Ultimate wind pressure: $\pm 3\text{KPa}$
- With rigid weather barrier:
 - Serviceability wind pressure: $\pm 2.5\text{KPa}$
 - Ultimate wind pressure: $\pm 4.5\text{KPa}$

The above wind pressures shall be calculated as per AS1170.2. For higher wind pressures, a project specific assessment or design by project (façade) engineer is required to ensure suitability and compliance.

Weather (resistive) barrier

The type of weather barrier plays an important role in the effective moisture and condensation management of an external wall. It is the responsibility of the project (façade) engineer or designer to specify an appropriate type of weather barrier. For projects with serviceability wind pressure of 2 KPa or less and ultimate wind pressure of 3 KPa



For information about technical properties and correct application of pro clima products refer to pro clima technical documents, and SOLITEX EXTASANA® Application and Fixing Guides.

For information regarding Siniat Weather Defence® and its applications refer to Siniat Weather Defence Technical Manual.

Design considerations

or less, the recommended pro clima SOLITEX EXTASANA® pliable membrane (wall wrap or sarking) may be used. Projects with higher wind pressures generally require a rigid air barrier.

EQUITONE has been independently tested and assessed with pro clima SOLITEX EXTASANA® pliable membrane for the purpose of compliance with the NCC 2022 F3P1 and H2P2. Where a rigid air barrier is required Siniat Weather Defence® may be used. Siniat Weather Defence® also increases the acoustic and fire performance of the façade.

Weather barrier shall be installed in accordance with its manufacturer's recommendations, applicable standards and regulations.

Both pro clima SOLITEX EXTASANA® and Siniat Weather Defence® have a high level of vapour permeance (classified as Class 4 as per AS/NZS 4200.1). The low vapour resistance (high vapour permeance) assists with condensation management where a breather type (vapour permeable) weather barrier is required. It is recommended that a condensation risk analysis is conducted by project engineer or designer for the appropriate selection of the required weather barrier.

The drained and fully ventilated cavity of EQUITONE façade system does assist further with managing condensation as well as keeping the cavity components and weather barrier dry.

In ensuring an effective moisture management of an external wall, the appropriate selection and application of the required flashing/sill tapes (and the like), sealant and flashings play an important part. Pro clima offers a range of tape, weatherproofing and sealing solutions some of which have been incorporated and recommended as part of EQUITONE systems. Consult with your project (façade) engineer for the selection of the required flashings and sealant suitable for your project and intended application. Generally, silicone sealant tends to perform better than other standard sealant types in terms of movement flexibility and UV stability.

Thermal performance and energy efficiency

It is the responsibility of the project designer or engineer to ensure the building envelop including external walls are designed to meet the thermal and energy efficiency requirements of the project, the NCC and applicable regulations. The required level of thermal and acoustic performance of an external wall may be achieved by the selection of appropriate insulation and limiting of heat loss pathways, thermal bridging. The thermal insulation values of external wall may be determined as per the relevant provisions of the NCC and applicable standards including but not limited to AS/NZS 4859.2 for individual building components.

Reducing thermal bridging is also important in managing energy efficiency and condensation. Depending on the building Class, where substructure and support frame are metal, application of a thermal break with a minimum R-value may be required between the substructure and support frame as per the requirements of the NCC. Consult with your project engineer to determine the need for suitable thermal break to ensure compliance with the NCC.

To ensure energy efficiency with regards to artificial heating and cooling, a building should have an appropriate level of air-tightness, as needed based on its use, internal conditions, and geographical location. The weather barrier including all its penetrations should be adequately sealed to help achieve the required minimum air infiltration rate. Refer to the relevant sections of the NCC for the minimum requirements relevant to your project.

To benefit from all the advantages of a ventilated façade and to significantly reduce or even eliminate thermal bridging, appropriate external insulation may also be used. Refer to Etex Exteriors ANZ technical department for further information on this type of application.

Impact resistance

EQUITONE panels as high density fibre cement material typically offer strong impact resistance. However, in high traffic areas or applications demanding higher impact resistance, such as sports facilities and transit hubs, closer spacing of the support frame may be required to reduce unsupported spans of the panels and better withstand impact. This may be achieved with introducing additional support frame profiles between the main ones to which the panels are fixed. These additional profiles are not used to fix the panel but rather to support it at midspan against any impact.



Design considerations

Corrosion zones

EQUITONE panels may be used in all Australia corrosion zones provided that all system components, including support frame, flashings and fixings, are of adequate corrosion resistance appropriate for the project location. Corrosion zones are detailed in AS 4312 and ISO 9223.

It is the responsibility of the project designer or engineer to ensure the project is designed in accordance with the NCC requirements for corrosion resistance, and that EQUITONE system is appropriate for the intended application. Ensure all façade components including capping and flashings are designed according to the project wind and corrosion category.

Cyclonic areas

EQUITONE façade has been tested to AS 4040.3 with its proprietary face fixings to metal support frame and has been independently evaluated for applications in cyclonic areas with EQUITONE face fixings only. EQUITONE with concealed fixings has not been tested and evaluated, and therefore is not recommended, for applications in these wind regions.

In some cases, there is a requirement for the building envelope to be designed to withstand the impact of flying (wind-borne) debris in cyclonic areas. In such cases, an impact-resistant metal backing layer suitable for this purpose may be used. Consult your project engineer to determine the appropriate solution.

EQUITONE panels have undergone independent testing in accordance with relevant standards, with various metal backing options installed behind the cladding support frame, attached to the external wall's steel studs. Refer to project engineer to determine what impact velocity is required for the project. Consult EQUITONE technical team for further information about the installation details of the recommended metal sheeting.

Impact Velocity (m/s)	Metal Backing Layer
34	One layer of 0.75 mm G300 galvanised or Zinalume metal sheeting
40	Two layers of 0.75 mm G300 galvanised or Zinalume metal sheeting

External fixtures

Generally, no additional structural loads should be transferred to EQUITONE panels. Small surface mounted features like small cameras and lights may be fixed to EQUITONE if they are fixed only to one panel and not bridged and fixed to two or more panels. Larger surface mounted features, external fixtures, gutters, and downpipes must be fixed through an oversized hole in EQUITONE to structure or a dedicated support frame behind EQUITONE panels. The hole in EQUITONE should be oversized by at least 5-10 mm; the hole must be fully sealed with appropriate sealant. Services, e.g. pipes, and any additional support frame applied in the cavity for the support and fixing of any external fixtures must not block drainage and ventilation paths in the cavity.

Fire safety

EQUITONE is fibre cement material and as such is deemed non-combustible in accordance with the following clauses of the NCC, and may be used wherever a non-combustible material is required.

- C2D10(6)(d) of the NCC 2022 Volume 1
- H3D2(1)(d) of the NCC 2022 Volume 2
- C1.9e(iv) of the NCC 2019 Volume 1 (Amendment 1)
- 3.7.1.1(d) of the NCC 2019 Volume 2 (Amendment 1)

EQUITONE façade materials are classified as a 'Group 1' in accordance with AS 5637.1 and meets Specification C2D11, fire hazard properties, of the NCC 2022 Volume 1, and therefore may be safely used for internal lining and ceiling applications.

Design considerations

Both recommended flexible and rigid weather barrier options meet the fire hazard properties of the NCC. Pro clima SOLITEX EXTASANA® with a flammability index of less than 5 and a thickness of less than 1 mm meets the requirements of the NCC 2022 C2D10(6)(f) & H3D2(1)(f), and Siniat Weather Defence® is compliant with the provisions of the NCC 2022 C2D10(6)(a) & H3D2(1)(a).

In multistorey buildings where fire cavity barriers may be required within the façade cavity, it must be ensured that it does not block drainage and ventilation paths within the cavity. A minimum gap of 20 mm or greater as recommended in the 'Cavity width' section of this document is required between the rear of the cladding and front face of the fire cavity barriers. To achieve this, a fire cavity barrier suitable for ventilated façade, which are usually intumescent type, may be used. Consult with your project designer or (fire) engineer to determine the need for and the type of any fire cavity barriers appropriate to your project and intended application.

Bushfire zones

EQUITONE as a fibre cement material may be used in all Bushfire Attack Levels provided that the construction is in accordance with AS 3959 – Construction of buildings in bushfire-prone areas – and the relevant provisions of the NCC. In bushfire prone areas, all cavity air inlets and outlets shall be fitted with a corrosion-resistant metal or aluminium angle or mesh adequately perforated with aperture size of 2 mm. All gaps and holes larger than 3mm shall also be covered or backed with a corrosion-resistant metal or aluminium sleeve or backing strip.

Additional considerations for applications in Bushfire Attack Level of BAL-40 & FZ:

- In BAL-40, only 10 mm EQUITONE [tectiva] and [lunara] as well as 12 mm EQUITONE finishes may be used unless the external wall is designed to have a Fire Resistance Level (FRL) of 30/30/30
- In BAL-FZ, the external wall shall have an FRL of 30/30/30

Refer to the 'Fire rated walls' section of this document for the fire resistant systems available from Promat Australia and Siniat Australia. For further information about the requirements of construction in BAL zones, refer to AS 3959. NCC 2022 Specification 43 –Bushfire protection for certain Class 9 buildings – provides further requirements for Class 9 buildings located in bushfire prone areas.

Design considerations

Fire rated walls

EQUITONE fibre cement materials may be installed to a fire rated wall. The required FRL is achieved with the application of appropriate fire rated solution. Promat Australia and Siniat Australia offer a range of system solutions for fire rated walls, including the following systems with Siniat Weather Defence® and PROMATECT®100. Some of these solutions are listed in Tables 25 and 26.

Table 25 – Fire resistant system solutions with *steel* structure – All building classes

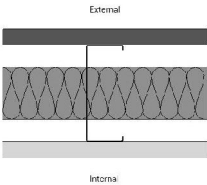
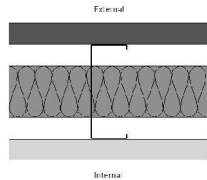
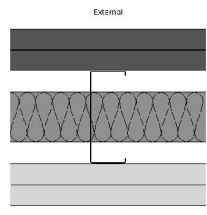
Drawing	Wall Components	Loadbearing Fire Resistance Level to AS1530.4	Non-Loadbearing Fire Resistance Level to AS1530.4	Acoustic Performance Rw (dB)	Additional Weather Protection (Sarking) Required
	External Side: 1 x 15mm PROMATECT®100 Frame: Steel – Min. 92mm x 35mm x 0.55BMT Internal Side: 1 x 15mm PROMATECT®100 Insulation: As per performance required	NA	-/60/60 (From both sides)	Up to 50	Yes*
	External Side: 1 x 20mm PROMATECT®100 Frame: Steel – Min. 92mm x 35mm x 0.55BMT Internal Side: 1 x 20mm PROMATECT®100 Insulation: As per performance required	NA	-/120/120 (From both sides)	Up to 51	Yes*
	External Side: 2 x 20mm PROMATECT®100 Frame: Steel – Min. 92mm x 35mm x 0.55BMT Internal Side: 2 x 20mm PROMATECT®100 Insulation: As per performance required	NA	-/240/240 (From both sides)	Up to 59	Yes*

Refer to the next page for notes on this table.

For technical support and more information about Siniat and Promat fire rated system solutions visit www.siniat.com.au/en-au/ and www.promat.com/en-au/.

Design considerations

Table 26 – Fire resistant system solutions with *timber* structure – Class 1 & 10 buildings

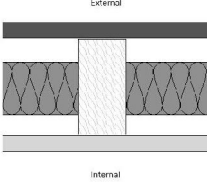
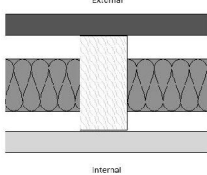
Drawing	Wall Components	Loadbearing Fire Resistance Level to AS1530.4	Non-Loadbearing Fire Resistance Level to AS1530.4	Acoustic Performance Rw (dB)	Additional weather protection (sarking) required
 <p>External</p> <p>Internal</p>	<p>External Side: 1 x 15mm PROMATECT*100 Frame: Timber – Min. 90mm x 45mm Internal Side: 1 x 15mm PROMATECT*100 Insulation: As per performance required</p>	60/60/60 (From both sides)	-/60/60 (From both sides)	Up to 41	Yes*
 <p>External</p> <p>Internal</p>	<p>External Side: 1 x 20mm PROMATECT*100 Frame: Timber – Min. 90mm x 45mm Internal Side: 1 x 20mm PROMATECT*100 Insulation: As per performance required</p>	90/90/90 (From both sides)	-/120/120 (From both sides)	Up to 41	Yes*

Notes for Table 25 & 26

- The information provided in Table 12 & 13 is only a general guide. Please refer to Promat Australia and Siniat Australia technical services for all system performance, current validity, and construction specifics
- Acoustic predictive values modelled in Marshall Day Insul 9

* PROMATECT® 100 must be protected from weather during construction phase and in service, and therefore application of a suitable pliable membrane (sarking) immediately after board installation is required. Use without sarking must be limited only to internal dry applications. Pro clima SOLITEX EXTASANA (ADHERO) may be used to protect PROMATECT® 100 from weather in external applications.



Maintenance & warranty

Inspections

EQUITONE façade is low maintenance; however, it is recommended to regularly check the facade for any possible soiling and clean as required. All facades, irrespective of the material used, should be inspected and if necessary, serviced regularly. Regular periodic inspections and maintenance are recommended to ensure long term performance of the façade and to prevent costly repairs and rectifications in time. The building also retains its continuous and attractive appearance.

If general soiling is allowed to work into materials for too long, it is possible that it will penetrate so deeply that simple cleaning is no longer possible. More rigorous and thus more expensive cleaning methods may have to be employed.

For that reason, periodic and preventive inspection of facades is recommended, so that imperfections can be discovered and resolved or repaired in good time. All ventilation and drainage gaps must always be kept unobstructed. All flashings and seals should be regularly inspected, and any damage should be immediately repaired.

Soiling process and metal cover flashings

Dust, soot, oils, greasy substances and atmospheric grime etc. are ever present in the air and rainwater, and can be deposited on most facades. If care is taken through considerate design and application, local soiling and runs can be avoided. This can be achieved by having adequate drip-moulding, such as overhanging window sills, good sealing and attention to combat corrodible materials such as zinc, copper, aluminium, steel etc. The degree and speed at which materials become soiled largely depends on the surface, chemical stability, hardness, porosity and ability to become electrostatically charged or not.

Where the façade is protected by a soffit or the like and hence not sufficiently exposed to rain, a more regular inspection and wash down may be required to prevent any salt and dirt build up. Coastal projects may also require more regular inspections and wash downs.

In principle, perform the cleaning of the facade over the entire surface, from top to bottom because partial cleaning can result in colour tonal differences.

Cleaning

There are two methods of cleaning facades, mechanical cleaning and chemical cleaning. In principle, perform the cleaning of the facade over the entire surface, because partial cleaning can result in colour and tonal imbalance. Normal stains can be removed with a sponge and water. The use of abrasive materials such as scourers, steel wool and the like are not permitted, as these leave irreparable scratches on the panel surface.

Any cleaning product used must be ammonia free. Solvent based cleaners such as acetone, white spirit, etc. attack the paint surface and are therefore not suitable. If there is doubt on the suitability of the cleaning product, use it first on a leftover piece of the façade or a less visible part of the façade (e.g. behind rainwater drain) to check if the agent doesn't damage the surface. There is a risk that the panel colour coating may become cloudy.

Facade parts and other materials (metal parts, glass) on the building that can be affected by the cleaning agent used must be protected. Do not use tapes that leave glue residues on the surface when fixing protective cover plastic foils.

Refer to EQUITONE cleaning and maintenance documents for detailed information and guidance on cleaning and maintenance of EQUITONE facade. Where cleaning of the façade is required, it should be conducted in accordance with EQUITONE cleaning and maintenance documents and the manufacturer's recommendations of the applied cleaning product or system.

Maintenance & warranty

Efflorescence

Small amounts of lime stains, cement splashes, or limescale deposits and light efflorescence can be removed with a 5% malic acid solution or commercial citric acid in a 10% concentration. The panels are treated with the solution using a paintbrush or a soft brush. After an exposure time of 2 to 3 minutes, the remaining solution is rinsed off thoroughly with plenty of water. If efflorescence is still visible after drying, the application must be repeated. The solution should never be allowed to dry on the surface. The solution must not be allowed to come into contact with the metal supporting frame as corrosion can occur.

When working with any acid solutions the operative must be fully trained and experienced in its application and removal. There is a risk that the panel colour coating may become cloudy.

Graffiti

The surface coating of EQUITONE [natura] PRO, [pictura], and [inspira] provides superior protection against common colours and spray paints. It is smooth and cleanable. Graffiti can be removed with dedicated graffiti removers. Cleaners with volatile solvents should not be used. The application instructions of the cleaning product manufacturers shall be strictly followed.

NOTE: The other EQUITONE finishes do have a graffiti resistant protection. EQUITONE [tectiva] and EQUITONE [lines] may receive an appropriate third party graffiti resistant coating, applied by others, prior to or after panel installation, in which case the appearance of the panel may change as the applied protection effects the light reflectance of the panel finish.

Warranty

EQUITONE product warranty is 15 years in Australia. Refer to 'EQUITONE product warranty' document for further information.



For further information about cleaning and maintenance refer to EQUITONE cleaning and maintenance documents.

For further warranty information and conditions refer to EQUITONE Product Warranty document.

Installation checklist

Checking the following items is recommended before starting the installation of EQUITONE cladding. The following list is by no means exhaustive.



For a step-by-step guide and information on the application of pro clima weather barrier and its components refer to SOLITEX EXTASANA® Application and Fixing Guides.

For further information regarding weather barrier refer to Design Consideration section.

Before installing weather barrier

- Ensure substructure has been designed to be serviceable for EQUITONE cladding (refer to the Design Considerations for further information).
- Check for and remove all sharp edges and burrs from substrate prior to application of a pliable membrane/sarking (weather barrier). Where a rigid weather barrier is intended to be used, check for any additional studs and noggins that may be required for fixing the rigid weather barrier.
- Ensure substructure is straight and plumb, and can adequately and structurally accommodate the required cladding framing.

After installing weather barrier

- Ensure the weather barrier and its associated components have been installed free of any defect and in accordance with their manufacturers' recommendations, project requirements and applicable standards and regulations.
- Ensure all the required flashings including those detailed in the EQUITONE Construction Details have been properly installed.



Check the quality of EQUITONE panels and components for any visual defects or damage prior to installation. Contact your local EQUITONE organisation for any issues. DO NOT install any panels or components which are either damaged or not aligned with the project requirements and specifications.

Before installing EQUITONE

- Ensure the building envelop is fully weatherproof, and all the junctions with openings and penetrations have been fully sealed as per the EQUITONE Construction Details, relevant standards and regulations, and project requirements.
- Confirm all the interfaces with EQUITONE, review architectural drawings as well as EQUITONE Construction Details and prepare accordingly.
- Ensure all the windows/doors (or the like) and their associated components, including any sill tray or flashing, and head and jamb flashing, have been installed as per applicable standards and regulations, project requirements, and EQUITONE Construction Details.
- Ensure panel sizes are correct, and all panel hangers have been correctly installed with correct spacing and adequate edge distances.
- Ensure adequate ground clearance as per EQUITONE Construction Details and regulatory requirements. Determine and mark bottom of the cladding.
- Ensure all panel edges are sanded and free of any dust. In case of EQUITONE [natura] and EQUITONE [natura] PRO, ensure all panel edges have been fully sealed with LUKO.
- Ensure the cladding support frame has been installed correctly, straight and plumb, and in accordance with its manufacturer's/supplier's recommendations and guidelines, project engineering design and relevant standards, and spaced as per engineering requirements.
- Ensure allowance for adequate air inlets and outlets, and ventilation within the cavity has been made, and the perforated angles or profiles have been installed where required.
- Ensure the length of the framing profiles (rails) is limited to 3m, and a minimum 20mm gap is left between any adjacent profiles.
- Ensure the required EPDM compressible gaskets have been applied on all support frame profiles as per the requirements outlined in this documents and EQUITONE Construction Details.
- Ensure the vertical rails, including any brackets, have been correctly installed to the substructure. NV1 vertical rails must be installed as per stop (fixed) and go (gliding) point principle; ensure the fixed and gliding points are correctly located per profile. Ensure fixed point brackets are fixed through the round holes, and sliding point brackets are fixed through the slotted holes.
- Confirm the need for any additional structural support required for accommodating any external fixtures or surface mounted features. Under no circumstances should EQUITONE panels receive any additional structural loads. Any applied additional supports must not block the air flow and drainage within the cavity.
- Ensure adequate allowance has been made for the thermal movement of the horizontal and vertical rails.
- Ensure all the required flashings have been installed correctly and in accordance with applicable standards and regulations, project requirements and EQUITONE Construction Details.
- Ensure the horizontal rails have been correctly fixed to the vertical rails with two fixings as recommended by NVELOPE.
- Ensure full knowledge of the correct installation of panels
- Ensure the maximum cantilever of horizontal rails does not exceed 300mm or less depending on project engineering.

Installation checklist

The following list is by no means exhaustive. It needs to be used in conjunction with other relevant EQUITONE technical documents.

Installation checklist

- O Before placing any panel on the façade, check the size of the panel, location/spacing of the panel hangers, and the edge distances are all correct. Ensure the panel is clean and free of any dust.
- O Ensure all panel hangers have two SFS fixings correctly installed.
- O Before installing a panel, ensure all the adjustment bolts of its top row hangers are adjusted to the mean position allowing for +/- 5mm adjustment.
- O After installation of each panel, ensure one of the fixing methods outlined in this guide, as appropriate, is applied to lock the panel in place and prevent any sidewise movement in service before moving onto the next panel.
- O After installation of each panel, ensure the full engagement of all panel hangers with horizontal rails.
- O Ensure the panel hangers are not used as a lifting lug or used to handle or hold the panel at any stage during panel installation.
- O Ensure allowance for control/movement joints e.g. under side of the slabs. Ensure panel and/or its support frame does not bridge any control/movement joint while fixed to both sides of it.
- O Ensure allowance for control and movement joints e.g. under side of the slabs. Ensure panel and/or its support frame does not bridge any control or movement joints while fixed to both sides of the control/movement joint.
- O Ensure allowance for adequate ventilation is made. Ensure adequate air inlet and air outlet at the bottom/top of the façade, interface with window sills and heads and the like, junctions with slabs and soffits are allowed.
- O Ensure all necessary coordination is done with other trades to ensure allowance for adequate air inlets and outlets (ventilation) as per EQUITONE ventilation requirements.
- O Adopt appropriate level of care to prevent any damage to panel finish and edges during panel installation.

After installation

- O Check the façade for any missing fixings, flashings, items, or defects.
- O Ensure the panels are cleaned after the installation in accordance with EQUITONE cleaning guidelines. The finished facade areas should be cleaned down following fixing of panels. Any partial cleaning may cause minor visual impairments.
- O Ensure panels are adequately protected after the installation where there is any risk of damage by other works.



Check the quality of EQUITONE panels and components for any visual defects or damage prior to installation. Contact your local EQUITONE organisation for any issues. DO NOT install any panels or components which are either damaged or not aligned with the project requirements and specifications.



EQUITONE ANZ
10-20 Jordan Close
Altona VIC 3018
Australia

+61 (03) 9988 2290
info.australia@equitone.com
equitone.com