



EQUITONE system

construction details

EQUITONE with concealed fixings

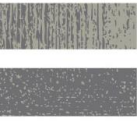

Table of contents

General information	3
Components	4
Support frame	7
Ventilation	9
EQUITONE façade system with pliable membrane	10
EQUITONE façade system with rigid air barrier	24



General information

This document provides generic construction details for EQUITONE façade systems with concealed panel fixings to assist with the design of EQUITONE façade.

This document is not designed to serve as an installation guide, and is intended to be used in conjunction with 'EQUITONE Design and Installation Guide_concealed fixing system' and other relevant technical and installation documents.

Construction details in this document have been independently certified for the purpose of compliance with the performance requirement of the F3P1 & H2P2 of the NCC 2022.

The weatherproofing performance of any project specific detail or application that is different from or not included in the construction details of this document shall be evaluated by the project engineer or consultant.

Cladding support frame and its connection to substructure shall be designed by the project engineer in accordance with the relevant standards. The support frame maximum deflection under the influence of load shall be limited to $\text{Span}/250$. The support frame, fixings, flashings and the like shall be of adequate corrosion resistance appropriate to the corrosivity category of the project location.

Refer to your local EQUITONE technical team for the specific requirements pertaining to the application of EQUITONE in bushfire prone areas (BAL).

Construction details contained in this document are not to a specific scale, and are for illustration purposes only.

The information in this guide is comprehensive but not exhaustive, and the reader will need to satisfy themselves that the contents of this guide are suitable for their intended application. It is the responsibility of the project consultants (designer, architect, and engineers) to ensure that the information and details provided in this document are appropriate for the project.

The information in this document is correct at the time of issuing. However, due to our committed program of continuous material and system development we reserve the right to amend or alter the information contained in this document without prior notice. Please contact your local EQUITONE sales organisation or visit www.equitone.com to ensure you have the most current version.

This document is supplied in good faith and no liability can be accepted for any loss or damage resulting from its use. Images and construction details contained in this document are not to a specific scale, and are indicative and for illustration purposes only.

This document is protected by International copyright laws. Reproduction and distribution in whole or in part without prior written permission is strictly prohibited. EQUITONE and logos are trademarks of Etex NV or an affiliate thereof. Any use without authorisation is strictly prohibited and may violate trademark laws.

Components

Materials



EQUITONE [lines]

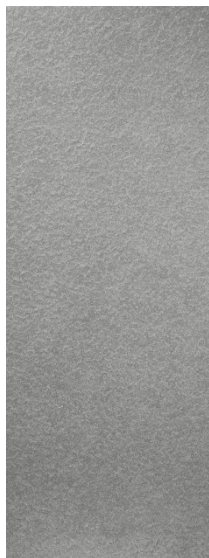

EQUITONE [lunara]



EQUITONE [tectiva]



EQUITONE [natura]



EQUITONE [pictura]

Maximum available panel sizes

EQUITONE [tectiva] 8 mm thick
EQUITONE [lines] 10 mm thick
EQUITONE [lunara] 10 mm thick

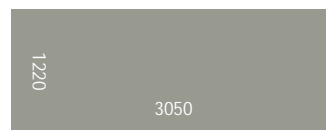

EQUITONE [natura] 8 and 12 mm thick
EQUITONE [natura] PRO 8 and 12 mm thick
EQUITONE [pictura] 8 and 12 mm thick

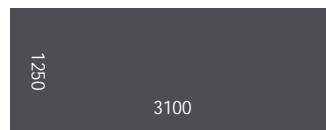
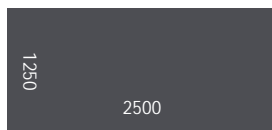

Panel fixings

SFS TUF-S

Stainless Steel 316 (A4) grade concealed fixings

Notes

The application of the SFS TUF-S fixings shall be in strict accordance with SFS guidelines and recommendations.

SFS TUF-S is available in various sizes suiting different panel thicknesses.

SFS TUF-S panel edge distance: 50 – 100 mm

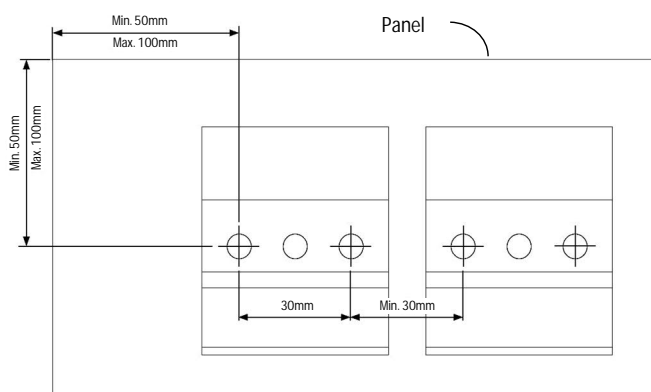

Components

Compressible EPDM gasket

12mm Tesa® 66703, 12mm Tesa® 61102, or
12mm PVC Tesa® 60106

A compressible closed-cell EPDM gasket used for sealing interfaces with flashings and the like.



NV3 horizontal express joint backing trim (baffle)

Black coated aluminium baffle is used to form expressed horizontal joints.

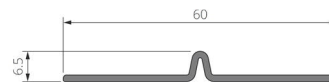

Double sided foam gasket

Tesa® 62936

A double sided closed-cell PE foam gasket may be used for fixing the baffle to back of the panels on baffled horizontal joints.



Weather resistive barrier option 1

pro clima SOLITEX EXTASANA® pliable membrane

Note
pro clima SOLITEX EXTASANA® is tested and certified with EQUITONE façade systems to AS4284 for the purpose of compliance with NCC 2022 F3P1 & H2P2 to the following wind pressures calculated to AS1170.2.
Serviceability wind pressure: $\pm 2\text{KPa}$
Ultimate wind pressure: $\pm 3\text{KPa}$
pro clima SOLITEX EXTASANA® shall be applied in accordance with AS4200.2 and pro clima SOLITEX EXTASANA® installation guidelines.
There are limitations with use of pro clima SOLITEX EXTASANA® with EQUITONE [material]. Refer to EQUITONE technical team for further advice.



Weather resistive barrier option 2

Siniat WEATHER DEFENCE® rigid air barrier

Note
Siniat WEATHER DEFENCE® is tested and certified with EQUITONE façade systems to AS4284 for the purpose of compliance with NCC 2022 F3P1 & H2P2 to the following wind pressures calculated to AS1170.2.
Serviceability wind pressure: $\pm 2.5\text{KPa}$
Ultimate wind pressure: $\pm 4.5\text{KPa}$
Siniat WEATHER DEFENCE® shall be applied in accordance with Siniat WEATHER DEFENCE® installation guidelines.



Flashing tape

pro clima TESCON EXTORA®

A pressure sensitive adhesive tape for overlaps and end laps used with both weather resistive barrier options.



Components

Sill tape

pro clima TESCON EXTOSEAL®

A flexible tape for use around window and door openings, used with both weather resistive barrier options.



Sealing tape

pro clima TESCON® NAIDECK mono patch

A single-sided adhesive nail or screw sealing adhesive used with both weather resistive barrier options.



Foil tape¹

pro clima TESCON® ADHISO WS

A pure aluminium tape for wet seal connections to TESCON EXTOSEAL® and EXTORA® and SOLITEX EXTASANA®



Grommet

pro clima ROFLEX and KALFEX

pro clima ROFLEX is used to seal pipe and pro clima KALFEX for cable penetrations. pro clima ROFLEX and KALFEX are used with both weather resistive barrier options.



¹ Foil tape is optional and not required when using sealants which are compatible with TESCON EXTOSEAL® and EXTORA® and SOLITEX EXTASANA®. Check with the sealant manufacturer for compatibility with pro clima products.

Support frame

Concealed fixing system
NVELOPE NV3

Thermal isolator gasket
Used to minimise thermal bridging, and to separate aluminium from steel or concrete.

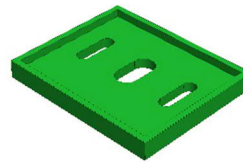

Bracket
NVELOPE aluminium brackets are available in two sizes, ie single and double, with various depths to suit a variety of cavity width from approx. 50 to 300mm.

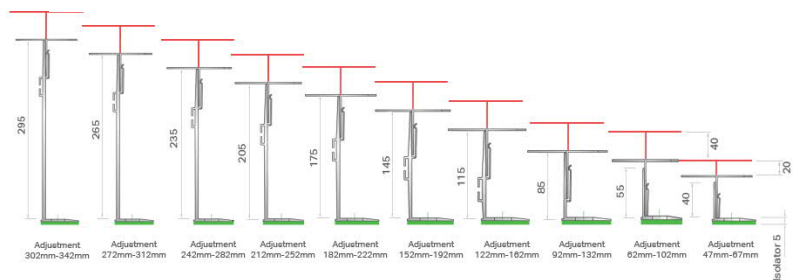
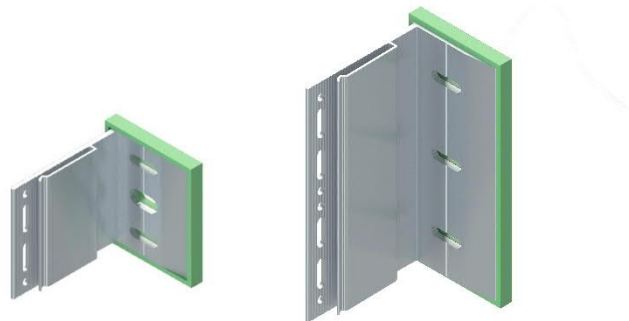

Vertical L rail (profile)
NVELOPE aluminium vertical L or T rails are used to form the required cavity behind EQUITONE panels for ventilation and drainage, and to support NV3 horizontal rails onto which EQUITONE panel is mounted.
Minimum face width: 40mm



Vertical aluminium Omega (top hat) or Z rail
These may substitute NVELOPE bracket and vertical L or T rails.

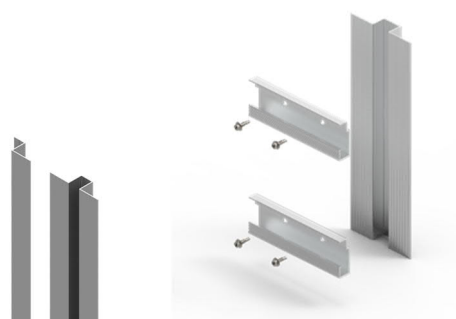

Support frame

Horizontal rail

NV3 aluminium horizontal rail onto which EQUITONE panel is mounted.



Hanger

NV3 aluminium hangers are fixed onto rear of EQUITONE panel with SFS TUF-S concealed fixings. There are two types of hanger – adjustable & static. The latter only applies to the top row panel fixings (hangers).

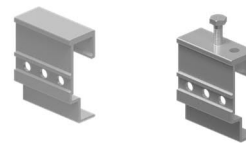

NV3 vertical express joint backing trim

Black coated aluminium backing trim is used to form expressed vertical joints.



Isometric view of the assembly

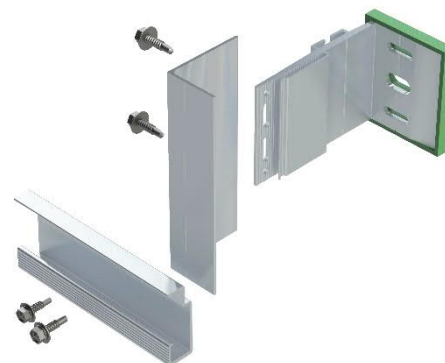

Notes

Maximum deflection of the support frame under influence of load shall be limited to $\text{Span}/250$.
Support frame and its connection to substructure shall be designed by project engineer in accordance with the relevant standards.
The application of SFS/NVELOPE system shall be in accordance with its supplier's recommendations and guidelines.
Refer to SFS/NVELOPE supplier for detailed information on SFS/NVELOPE components and their available sizes and options.

Ventilation

A ventilated façade is a kind of two stage construction, an inner structure with a protective outer skin, and the cladding panel or rainscreen. A ventilated façade consists of an insulated and weathertight structure, a ventilated cavity formed with a cladding support frame and the cladding panel.

Allowance for adequate ventilation is paramount in ensuring a successful EQUITONE façade. Ventilated façades provide a number of added benefits to the building and its occupants. These may include but are not limited to the following:

- Positive contribution to energy savings
- Assists with condensation management
- Minimises thermal bridges by providing an opportunity for applying external insulation
- Reduces thermal movement of the structure and cladding support frame
- Dissipates radiant heat
- Increases acoustic performance of the external wall
- Provides an effective drainage path for any moisture passing the cladding skin
- Eliminates the need for exposed caulking and sealant, therefore reducing maintenance requirements
- Assists with keeping the weather barrier dry and healthy
- Provides opportunities for concealing external services such as downpipes within the cavity
- Proven to be a more sustainable and healthier façade construction
- Architectural design flexibility

Air must be allowed to enter the cavity from bottom of the façade, window head, soffit, slab junctions, and the like, and exit from top of the façade, capping, window sill, slab and soffit interfaces, and the like.

It is recommended that all air inlets and outlets are protected against entry of birds and vermin into the cavity with a corrosion resistant perforated profile (angle).

The perforated angle should be less than 0.8mm in thickness where placed between EQUITONE and the support frame, and should have a minimum 50% open area.

In bushfire prone areas (BAL zones), all air inlets and outlets as well as gaps greater than 3mm shall be covered with a perforated angle, with aperture size of no greater than 2mm as per AS3959. In these areas, all horizontal panel joints should be baffled, and the wall construction shall be in accordance with AS3959. Refer to your local EQUITONE technical team for further information in relation to the application of EQUITONE in bushfire prone areas.

For further information, refer to Design and Installation Guides.

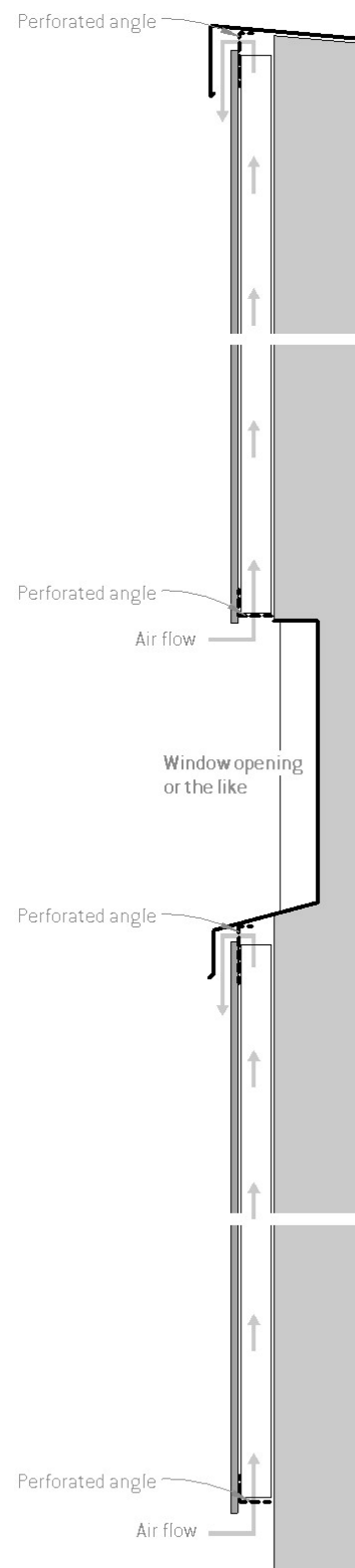

EQUITONE system

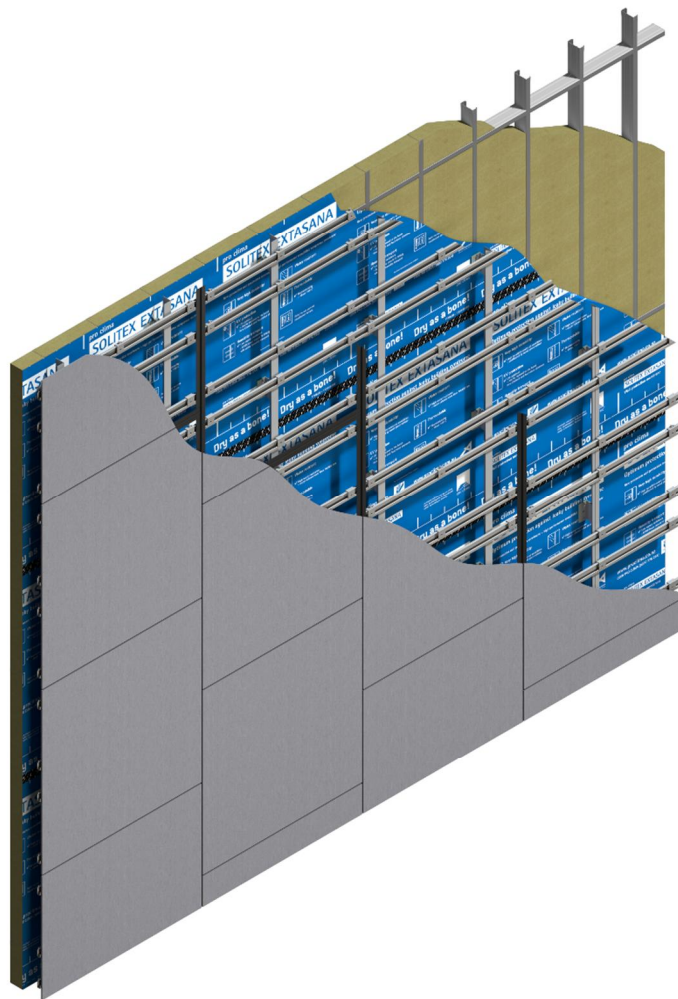

pro clima SOLITEX EXTASANA® pliable membrane

concealed fixing system

Drawings index

Detail	Figure	Page
Baffled horizontal joint	1	12
Baffled horizontal joint junction with vertical joint - Elevation	2	12
Vertical joint - Detail 1	3	13
Vertical joint - Detail 2	4	13
Intermediate panel fixings connection	5	13
Horizontal control joint	6	14
Vertical control joint	7	14
Window head and sill	8	15
Window jamb - Detail 1	9	15
Window jamb - Detail 2	10	15
Meter box - Section	11	16
Meter box - Plan view - Detail 1	12	16
Meter box - Plan view - Detail 2	13	16
Isometric view of window/meter box opening - Tape application	14	17
Soffit junction	15	17
Base detail	16	18
Base detail - Covered area	17	18
Base detail - Balcony	18	18
Exposed slab junction - Cladding flush	19	19
Exposed slab junction - Cladding recessed	20	19
External corner	21	20
Abutment	22	20
Internal corner	23	20
Pipe penetration - Plan view	24	21
Pipe penetration - Elevation	25	21
Pipe penetration - Section	26	21
Capping - Detail 1	27	22
Capping - Detail 2	28	22
Parapet junction - Section	29	22
Parapet junction - Plan view	30	23
Corrosion resistant saddle flashing	31	23

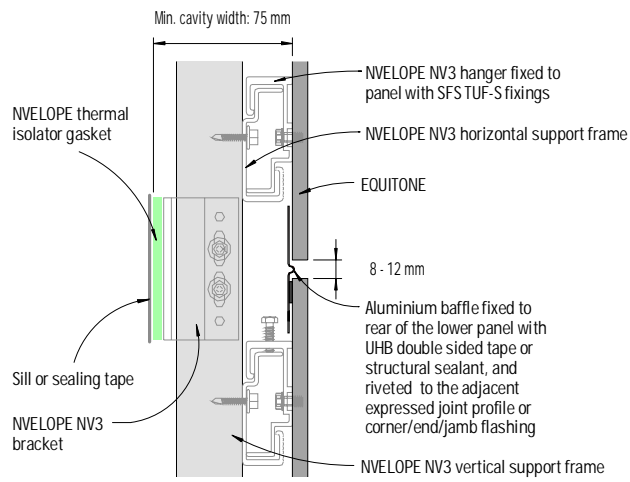

Figure 1: Baffled horizontal joint

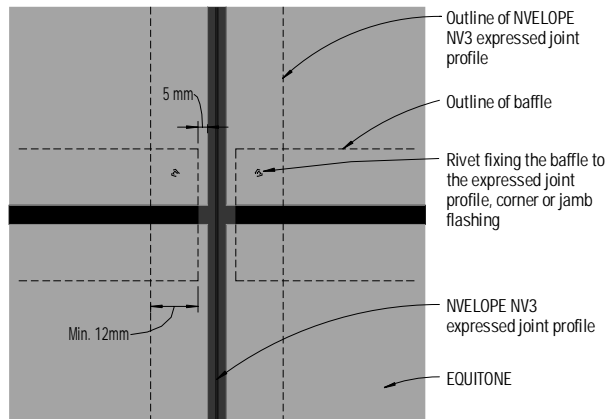

Figure 2: Baffled horizontal joint junction with vertical joint - Elevation

Note

For EQUITONE [material] refer to EQUITONE construction details with Siniat WEATHER DEFENCE.

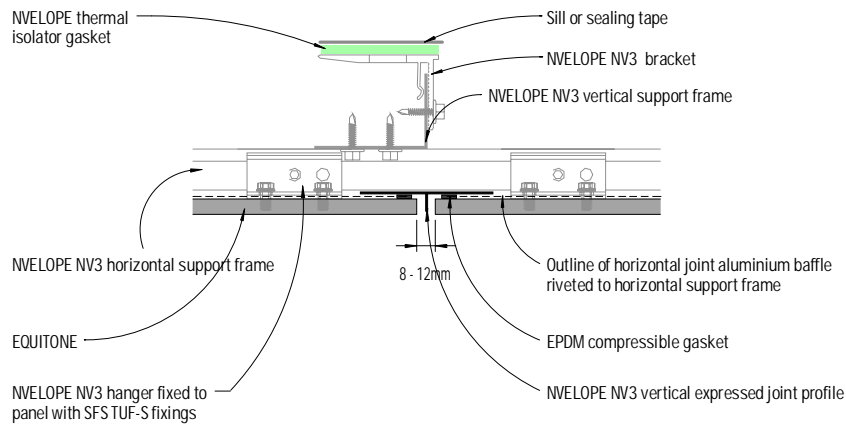

Figure 3: Vertical joint - Detail 1

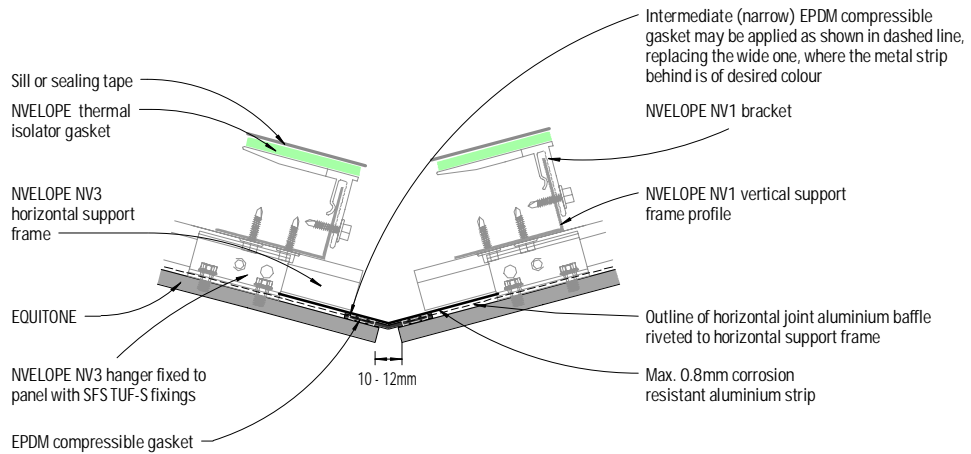

Figure 4: Vertical joint - Detail 2

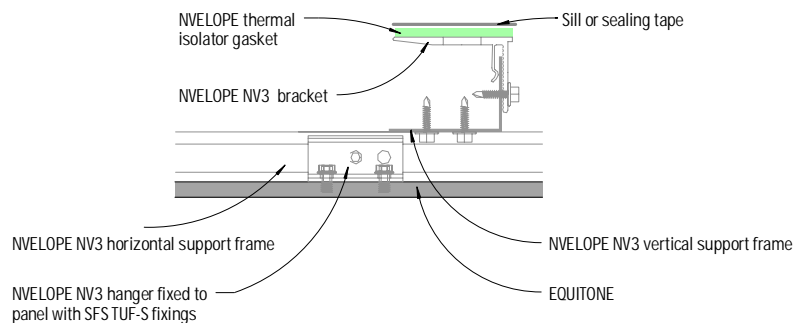

Figure 5: Intermediate panel fixing connection

Notes

- 1) The deflection of NVELOPE NV3 vertical expressed joint profile (as included in Figure 3) and any aluminium strip located at the vertical joint (as included in Figure 4) shall be limited to an extent ensuring the sealed along the vertical joint is maintained with respect to project wind loading.
- 2) The aluminium strip should be fixed ONLY to one of the support frame profiles (either left or right) where allowance for horizontal and/or vertical movement of the cladding frame is required.
- 3) For EQUITONE [material] refer to EQUITONE construction details with Siniat WEATHER DEFENCE.

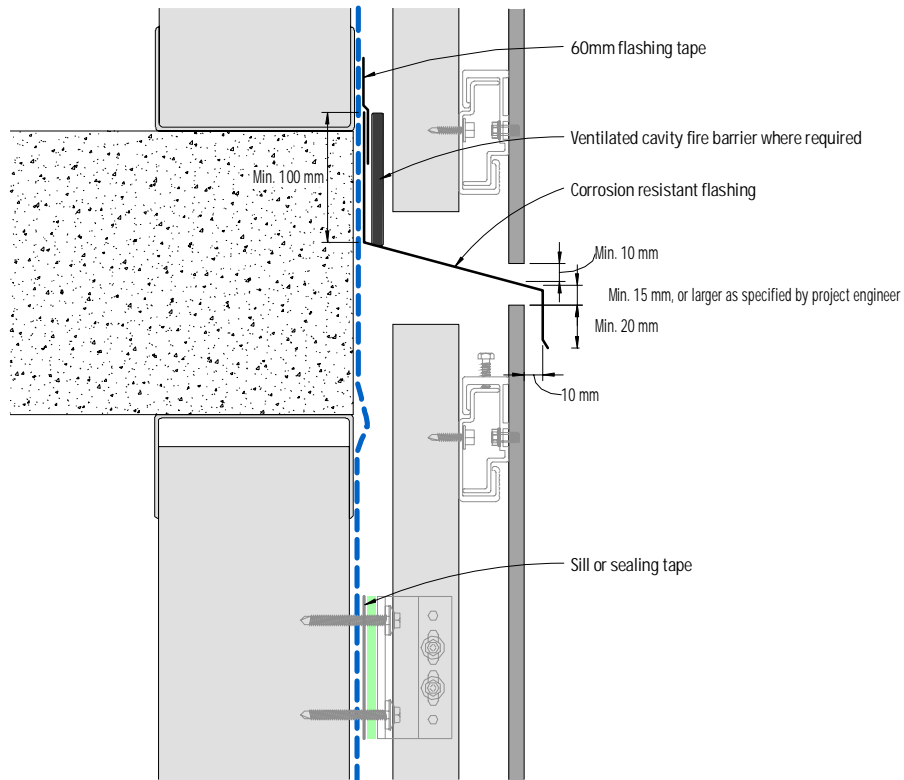

Figure 6: Horizontal control joint

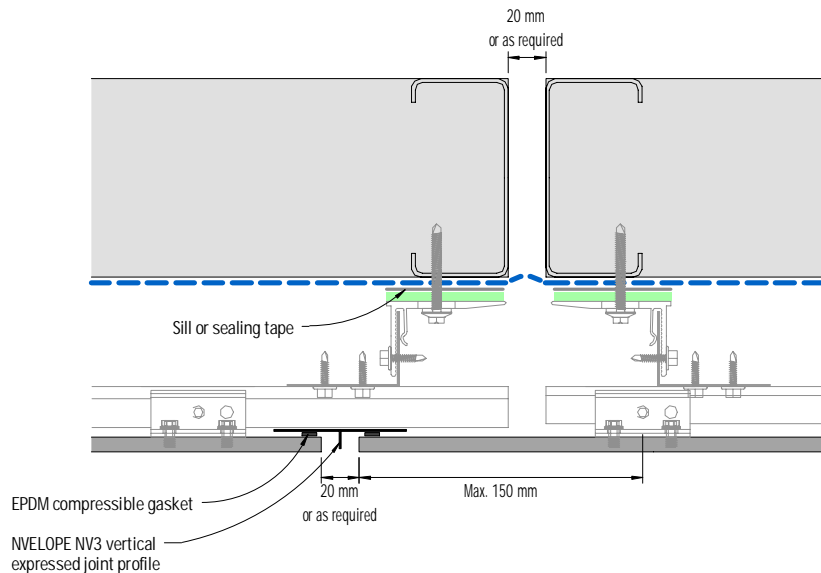

Figure 7: Vertical control joint

Notes

- 1) Support frame profiles must NOT be fixed crossing over a control joint nor to a deflection head.
- 2) Allowance for movement at the location of any control joint must be made in the cladding and its support frame design and installation. Panel must NOT be fixed bridging over any control joint.
- 3) The deflection of NVELOPE NV3 vertical expressed joint profile shall be limited to an extent ensuring the sealed along the vertical joint is maintained with respect to project wind loading.
- 4) The aluminium strip should be fixed ONLY to one of the support frame profiles (either left or right) where allowance for horizontal and/or vertical movement of the cladding frame is required.
- 5) For EQUITONE [material] refer to EQUITONE construction details with Siniat WEATHER DEFENCE.

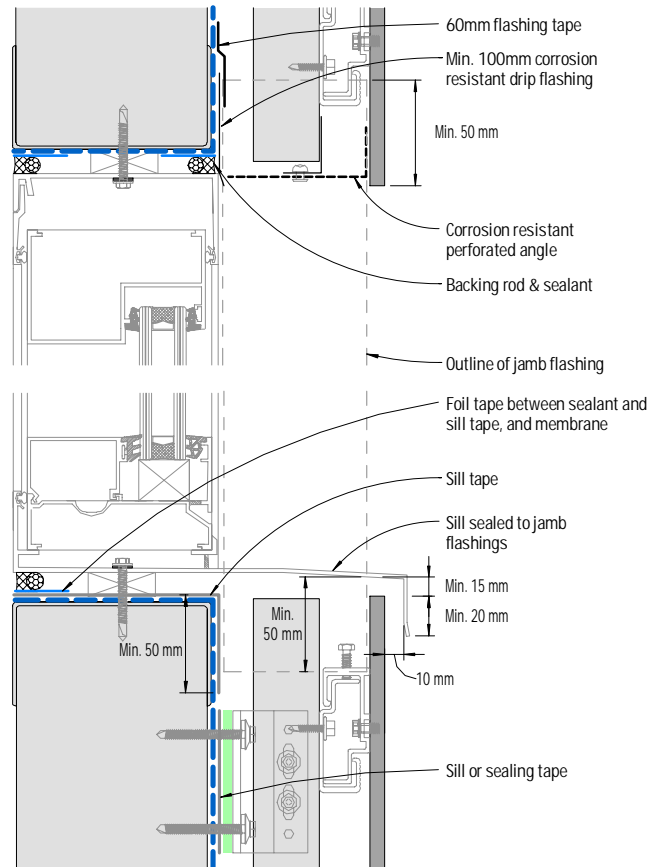

Figure 8: Window head and sill

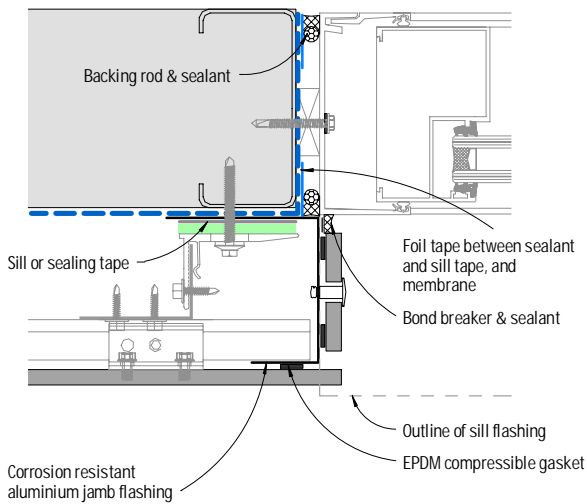

Figure 9: Window jamb - Detail 1

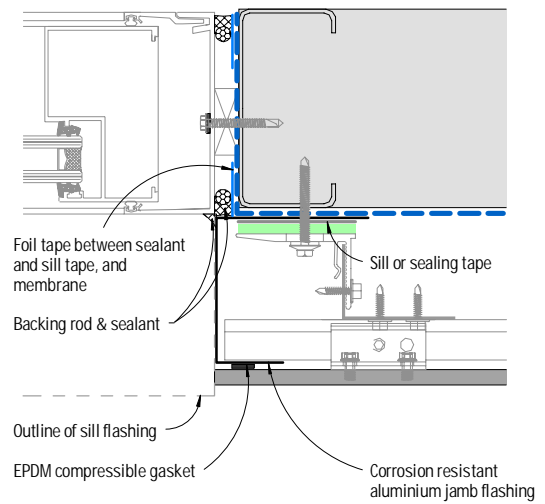

Figure 10: Window jamb - Detail 2

Notes

- 1) ONLY sealant compatible with the foil tape should be used. Should any sealant be intended to be used directly on the flashing and/or sill tape it must be confirmed with its manufacturer to ensure compatibility with these tapes in accordance with the relevant standards.
- 2) For EQUITONE [material] refer to EQUITONE construction details with Siniat WEATHER DEFENCE.

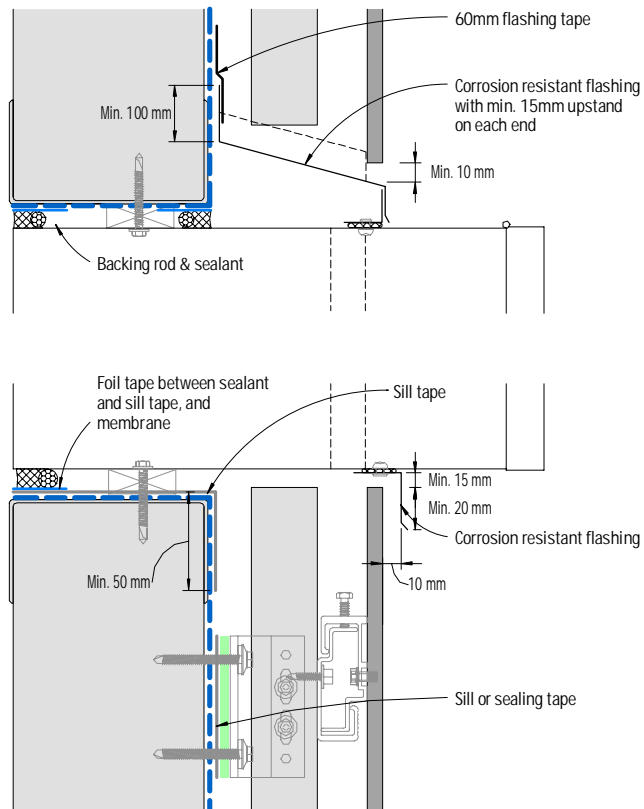

Figure 11: Meter box - Section

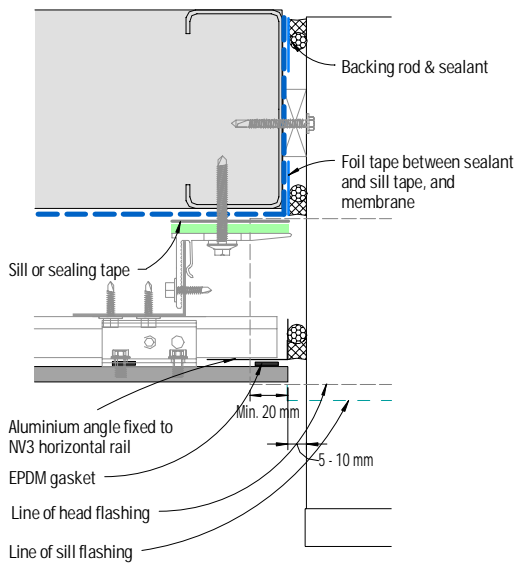

Figure 12: Meter box - Plan view - Detail 1

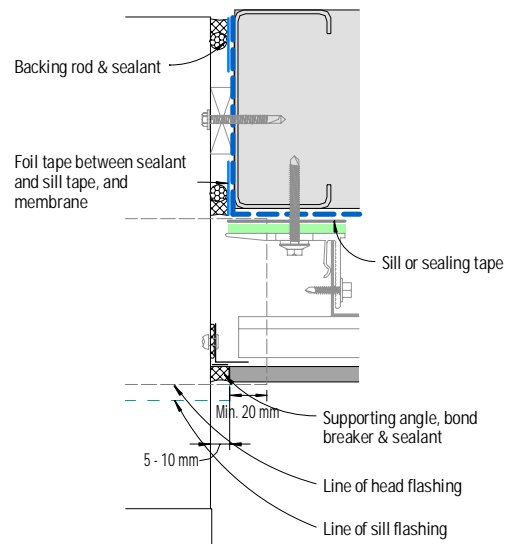

Figure 13: Meter box - Plan view - Detail 2

Notes

- 1) ONLY sealant compatible with the foil tape should be used. Should any sealant be intended to be used directly on the flashing and/or sill tape it must be confirmed with its manufacturer to ensure compatibility with these tapes in accordance with the relevant standards.
- 2) For EQUITONE [materia] refer to EQUITONE construction details with Siniat WEATHER DEFENCE.

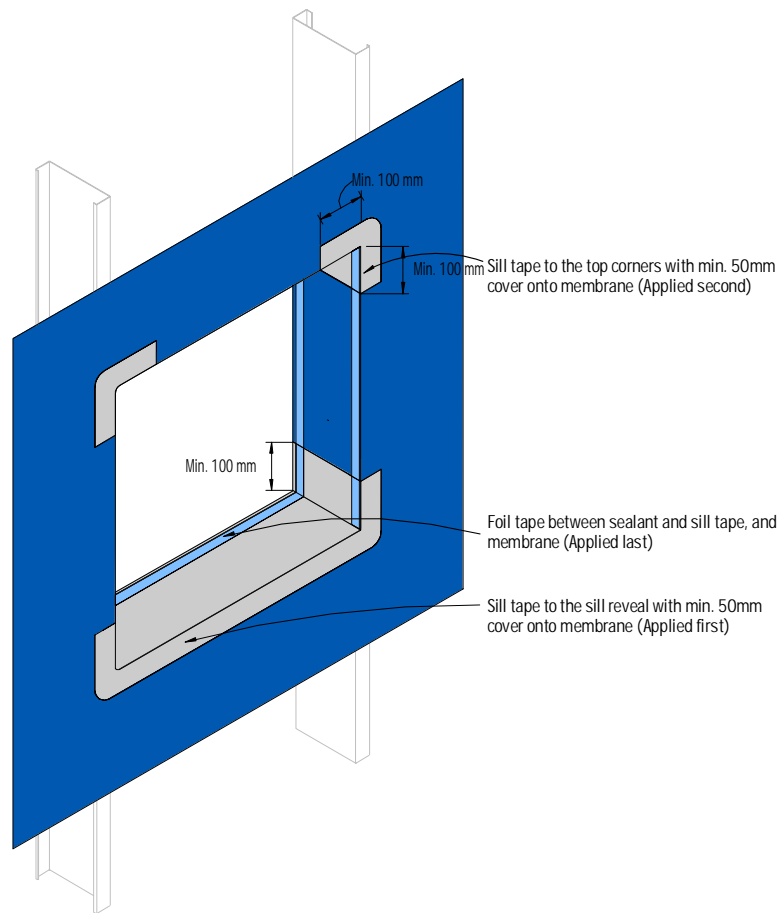

Figure 14: Isometric view of window/meter box opening - Tape application

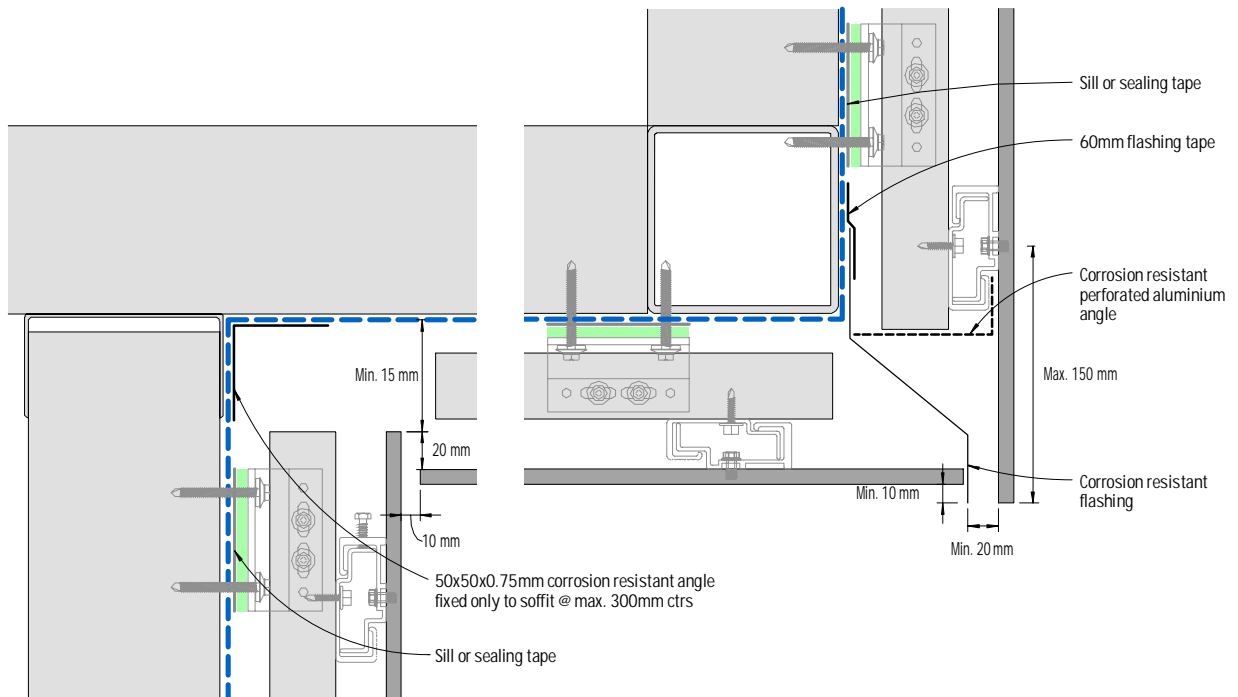

Figure 15: Soffit junction

Notes

- 1) ONLY sealant compatible with the foil tape should be used. Should any sealant be intended to be used directly on the flashing and/or sill tape it must be confirmed with its manufacturer to ensure compatibility with these tapes in accordance with the relevant standards.
- 2) Support frame profiles must NOT be fixed crossing over a control joint nor to a deflection head.
- 3) For EQUITONE [material] refer to EQUITONE construction details with Siniat WEATHER DEFENCE.
- 4) Corrosion resistant perforated angle shall be in Aluminium (or of adequate protective coating) to prevent bimetallic corrosion, be of max. thickness of 0.8mm where located between panel and support frame, and be of min. 50% open area.

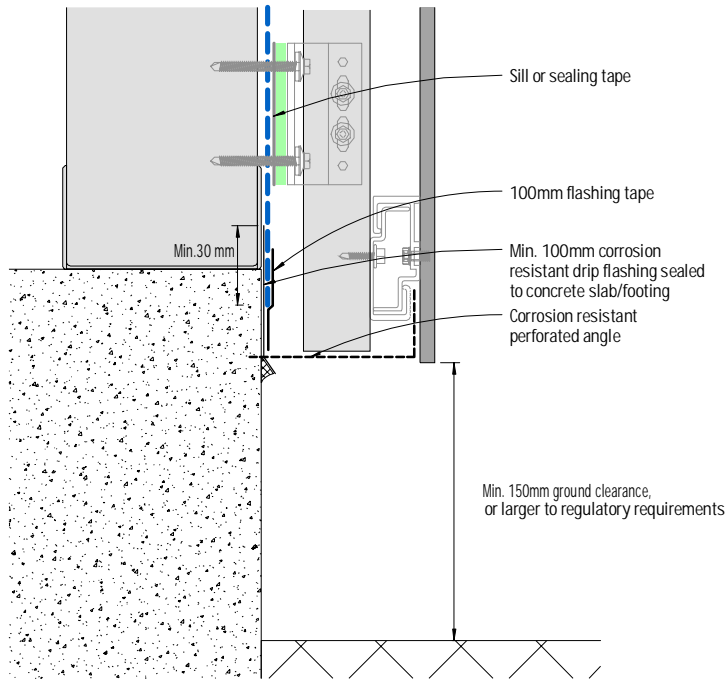

Figure 16: Base detail

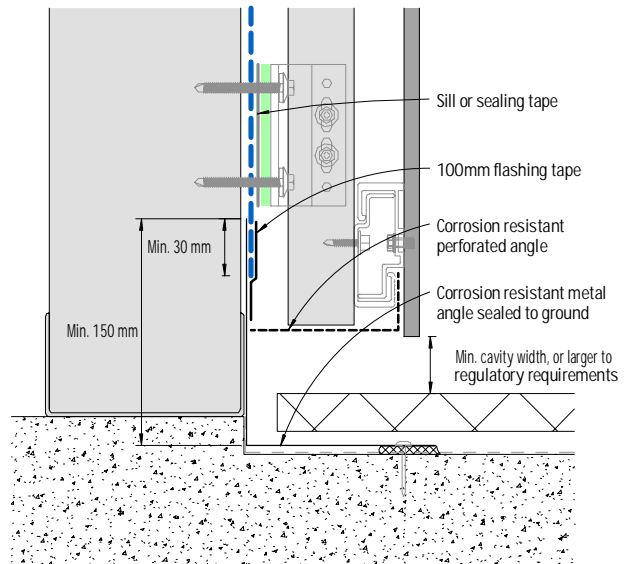

Figure 17: Base detail - Covered area

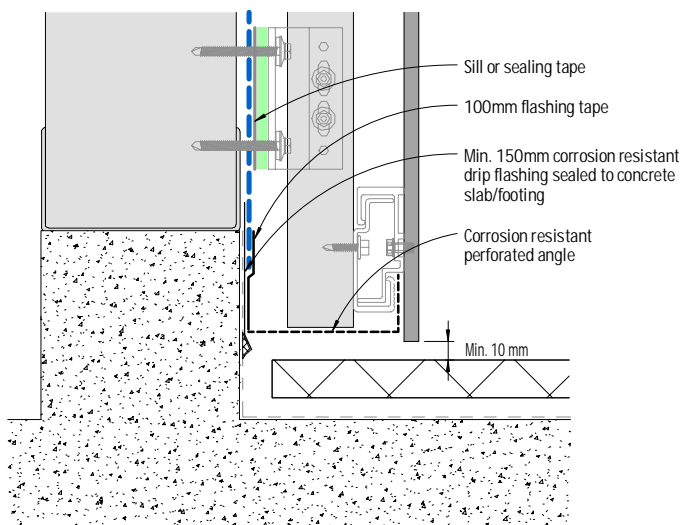

Figure 18: Base detail - Balcony

Notes

- 1) For EQUITONE [material] refer to EQUITONE construction details with Siniat WEATHER DEFENCE.
- 2) Corrosion resistant perforated angle shall be in Aluminium (or of adequate protective coating) to prevent bimetallic corrosion, be of max. thickness of 0.8mm where located between panel and support frame, and be of min. 50% open area.

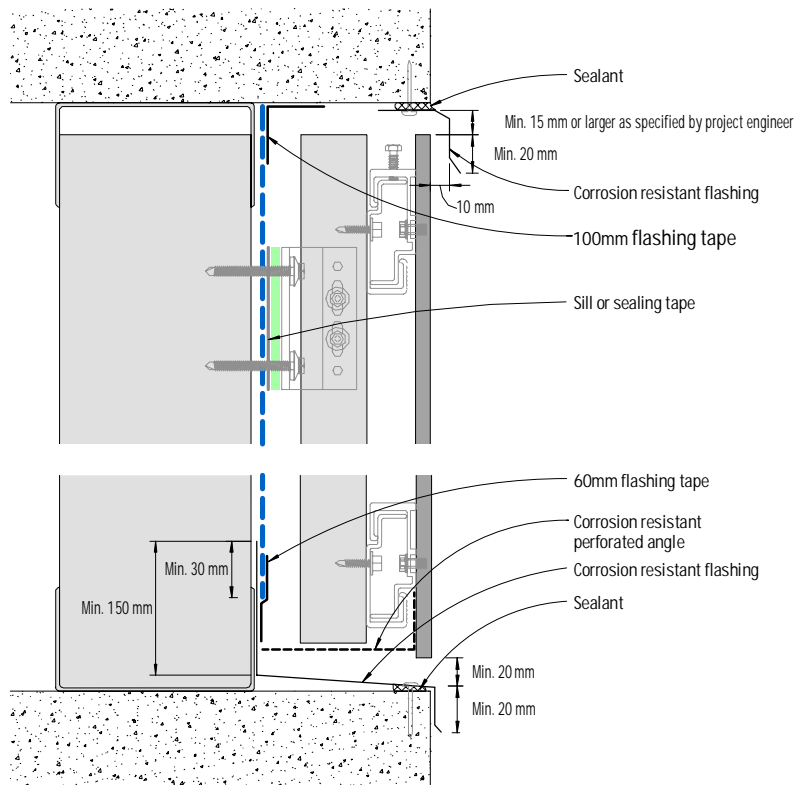

Figure 19: Exposed slab junction - Cladding flush

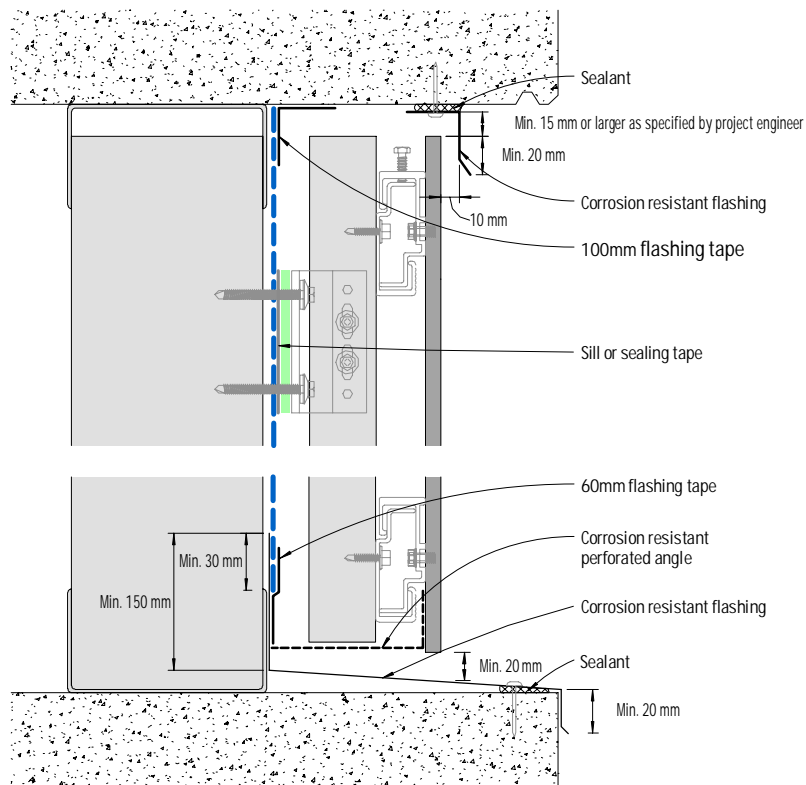

Figure 20: Exposed slab junction - Cladding recessed

Notes

- 1) Refer to Pro Clima's flashing tape application guide for any pre-treatment required on concrete or masonry for the application of the flashing tape onto these substrates.
- 2) Support frame profiles must NOT be fixed crossing over a control joint nor to a deflection head.
- 3) For EQUITONE [material] refer to EQUITONE construction details with Siniat WEATHER DEFENCE.
- 4) Corrosion resistant perforated angle shall be in Aluminium (or of adequate protective coating) to prevent bimetallic corrosion, be of max. thickness of 0.8mm where located between panel and support frame, and be of min. 50% open area.

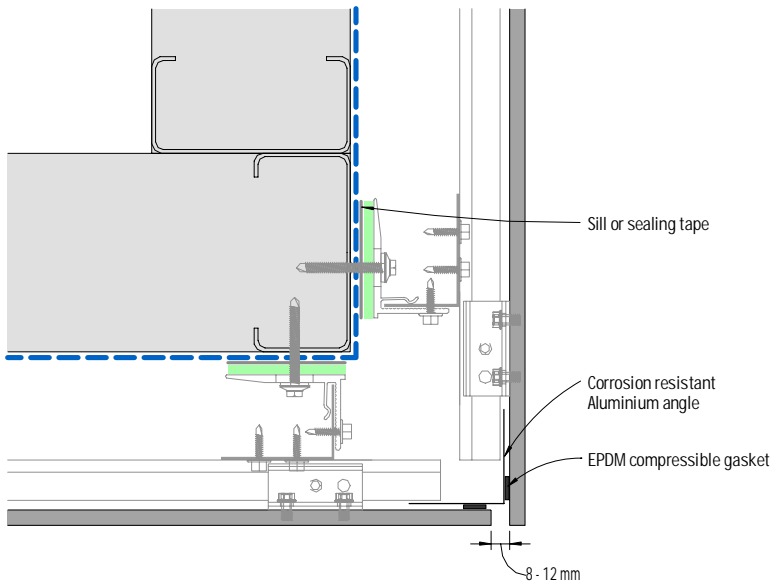

Figure 21: External corner

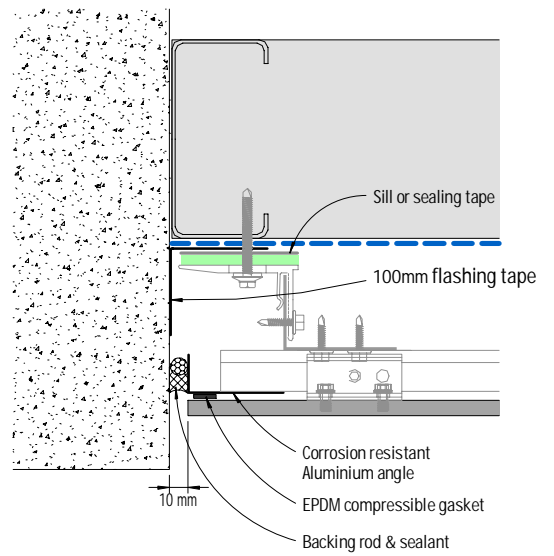

Figure 22: Abutment

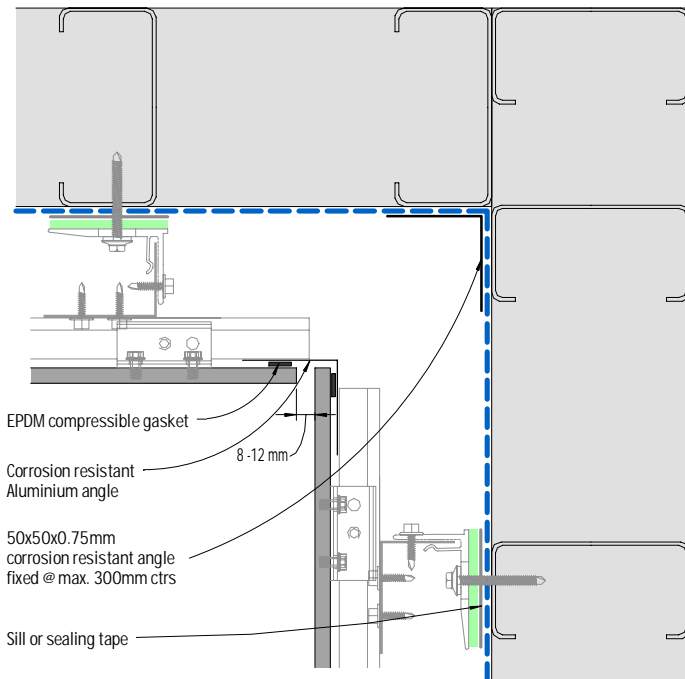

Figure 23: Internal corner

Notes

- 1) The deflection of Aluminium angle located at the vertical joint of internal/external corner shall be limited to an extent ensuring the sealed along the vertical joint is maintained with respect to project wind loading.
- 2) For EQUITONE [material] refer to EQUITONE construction details with Siniat WEATHER DEFENCE.

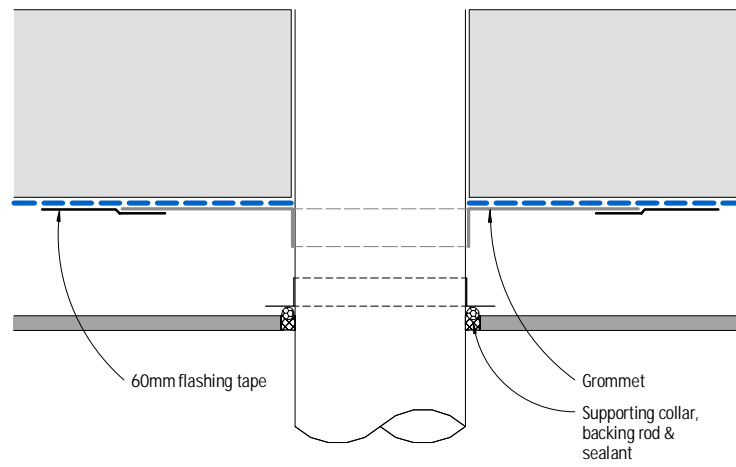

Figure 24: Pipe penetration - Plan view

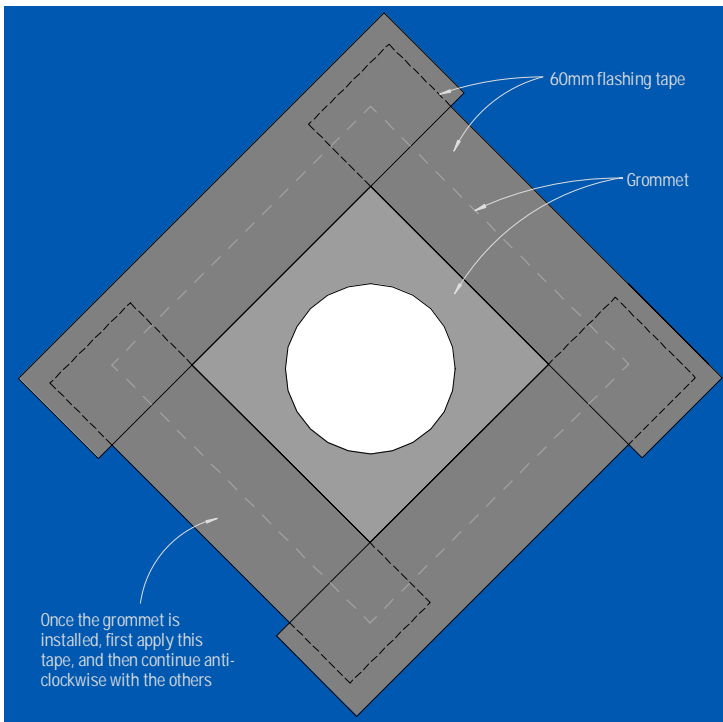

Figure 25: Pipe penetration - Elevation

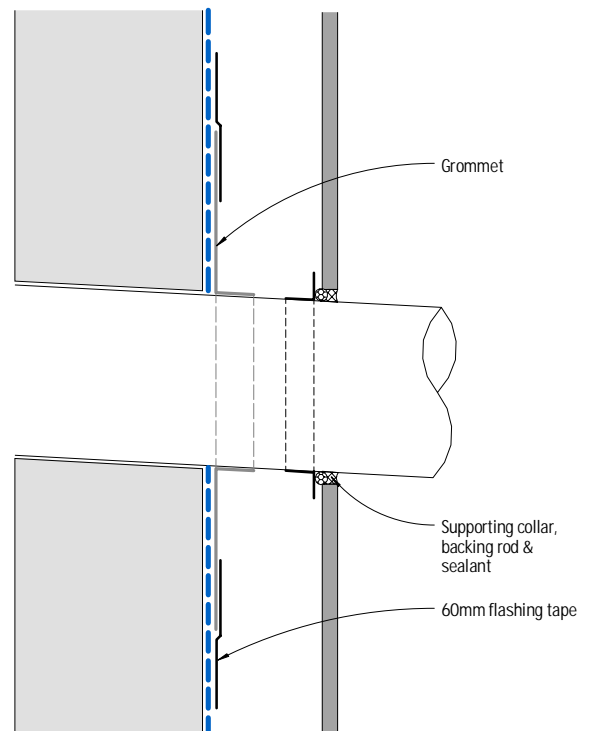

Figure 26: Pipe penetration - Section

Note
For EQUITONE [material] refer to EQUITONE construction details with Siniat WEATHER DEFENCE.

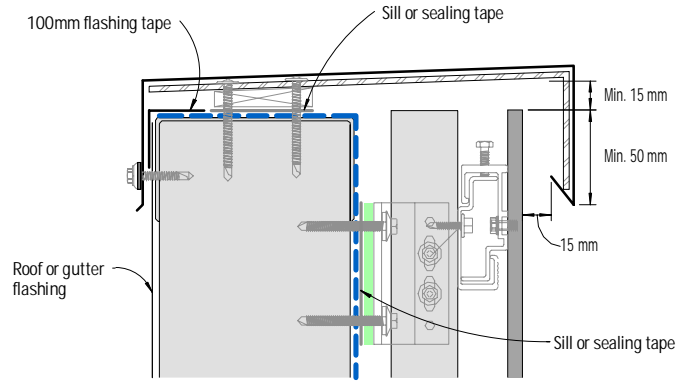

Figure 27: Capping - Detail 1

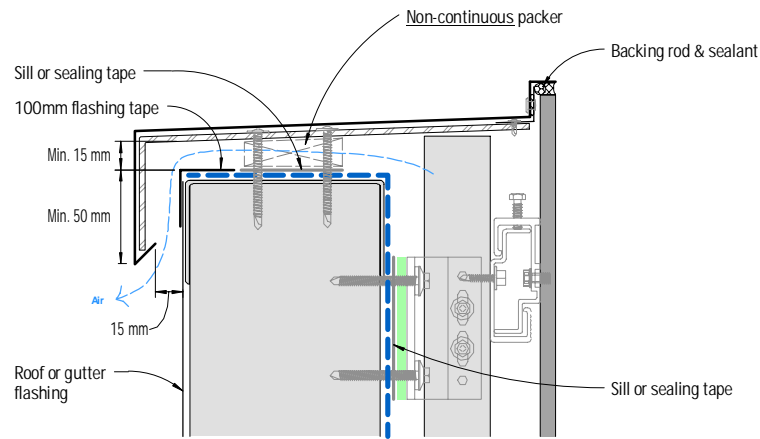

Figure 28: Capping - Detail 2

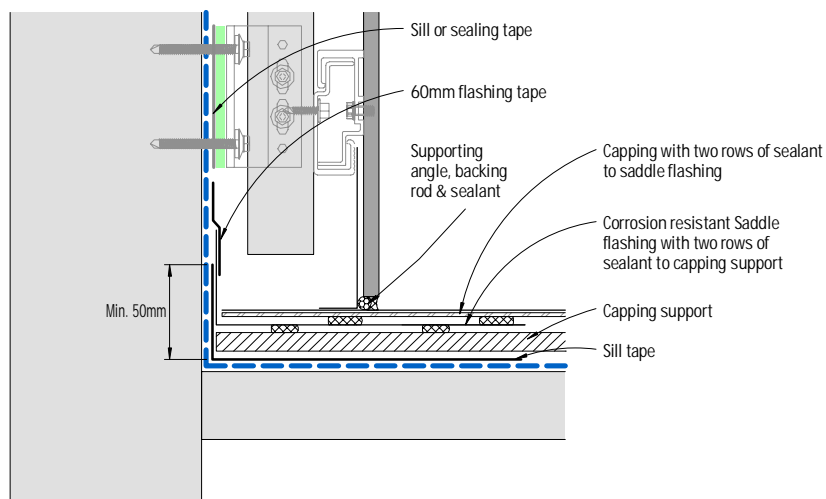

Figure 29: Parapet junction - Section

Notes

- 1) Capping '2' will involve further maintenance requirement in order to maintain the seal at the interface with the panel. Any deterioration of the sealant may result in panel staining, and will compromise the weatherproofing performance. Use UV stable and resistant external grade sealant.
- 2) For EQUITONE [material] refer to EQUITONE construction details with Siniat WEATHER DEFENCE.

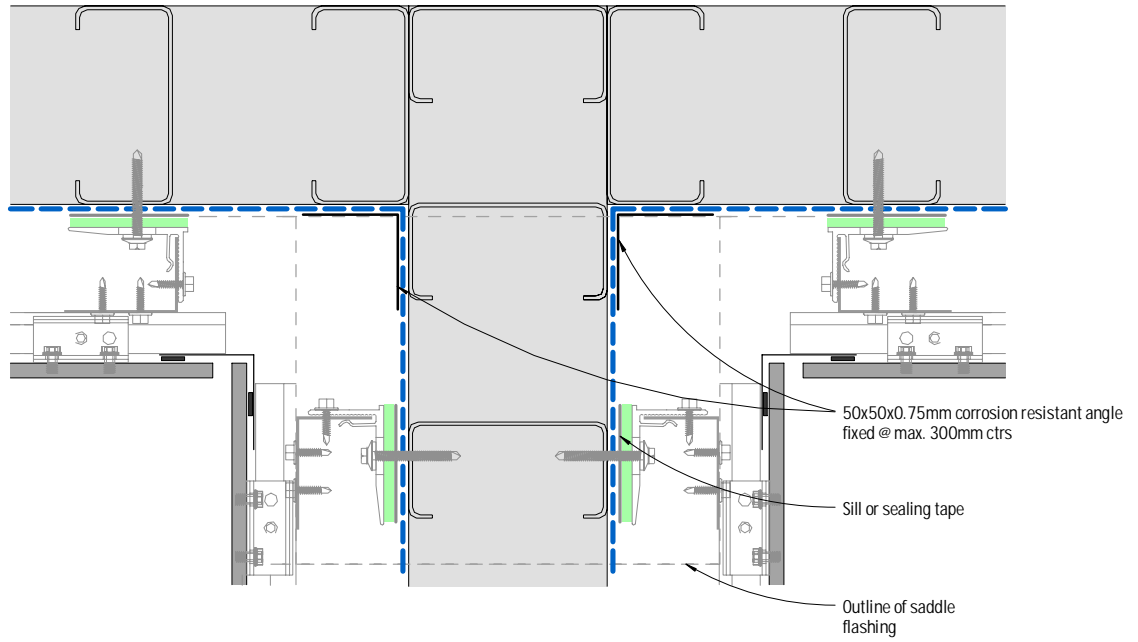

Figure 30: Parapet junction - Plan view

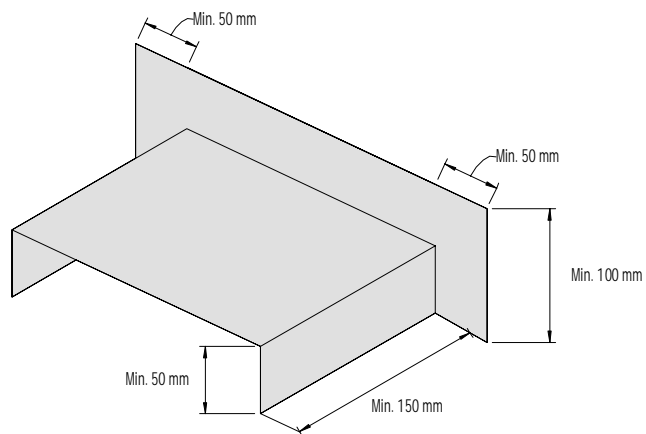
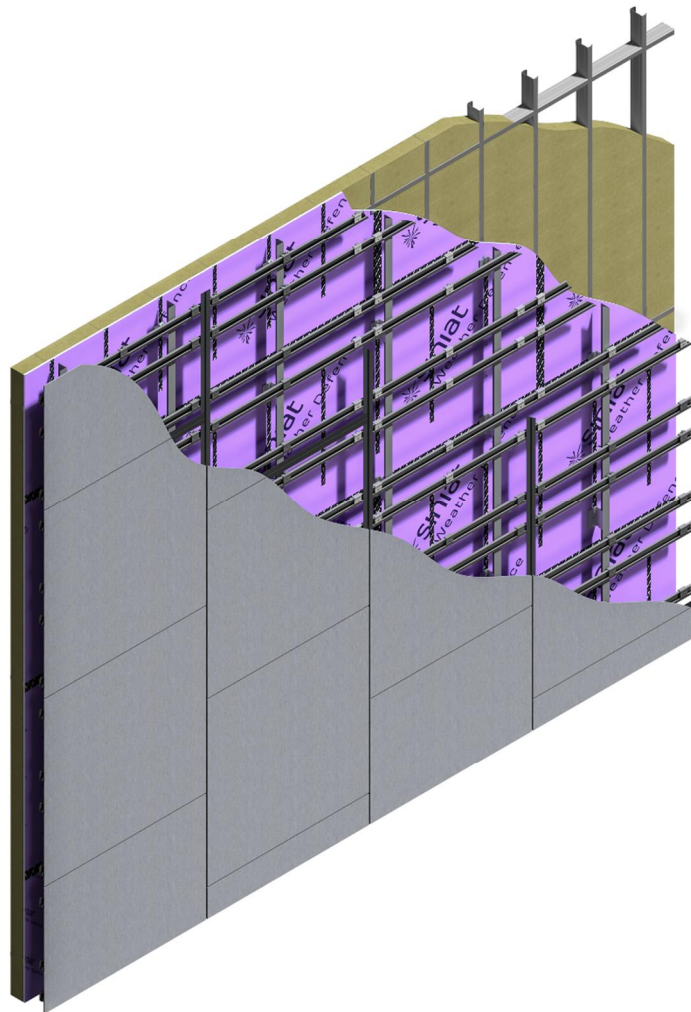

Figure 31: Corrosion resistant saddle flashing

Note
For EQUITONE [material] refer to EQUITONE construction details with Siniat WEATHER DEFENCE.

EQUITONE system



Siniat WEATHER DEFENCE® rigid air barrier
concealed fixing system

Drawings index

Detail	Figure	Page
Baffled horizontal joint	1	26
Baffled horizontal joint junction with vertical joint - Elevation	2	26
Open horizontal joint	3	26
Open horizontal joint junction with vertical joint - Elevation	4	26
Vertical joint - Detail 1	5	27
Vertical joint - Detail 2	6	27
Intermediate panel fixings connection	7	27
Horizontal control joint - Detail 1	8	28
Horizontal control joint - Detail 2	9	28
Vertical control joint	10	29
Window head and sill	11	29
Window jamb	12	29
Meter box - Section	13	30
Meter box - Plan view - Detail 1	14	30
Meter box - Plan view - Detail 2	15	30
Isometric view of window/meter box opening - Tape application	16	31
Soffit junction	17	31
Base detail	18	32
Base detail - Covered area	19	32
Base detail - Balcony	20	32
Exposed slab junction - Cladding flush	21	33
Exposed slab junction - Cladding recessed	22	33
External corner	23	34
Internal corner	24	34
Abutment	25	34
Pipe penetration - Plan view	26	35
Pipe penetration - Elevation	27	35
Pipe penetration - Section	28	35
Capping - Detail 1	29	36
Capping - Detail 2	30	36
Parapet junction - Section	31	36
Parapet junction - Plan view	32	37
Corrosion resistant saddle flashing	33	37

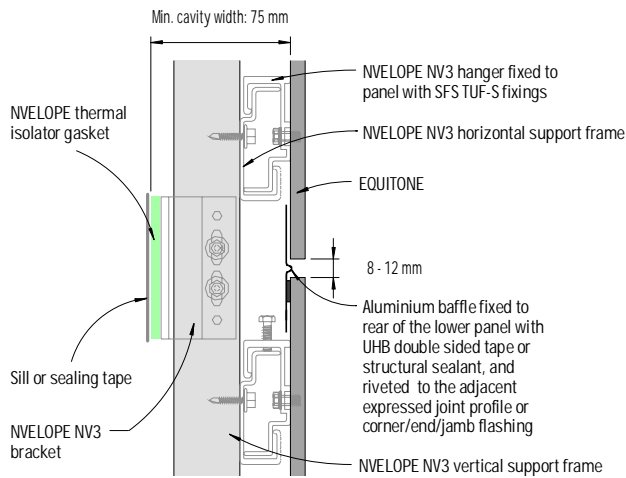

Figure 1: Baffled horizontal joint
(Not suitable for EQUITONE [material])

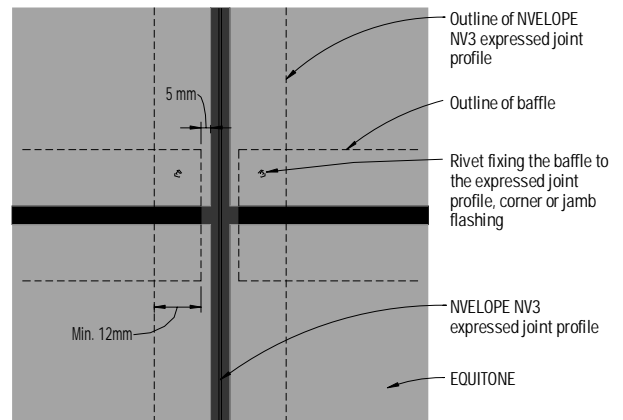

Figure 2: Baffled horizontal joint
junction with vertical joint - Elevation

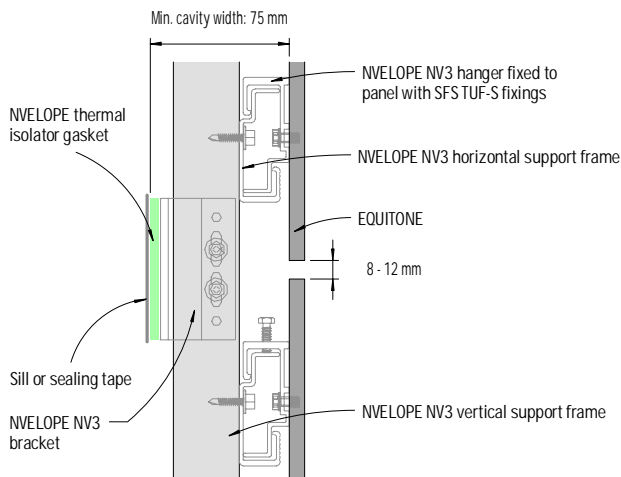

Figure 3: Open horizontal joint

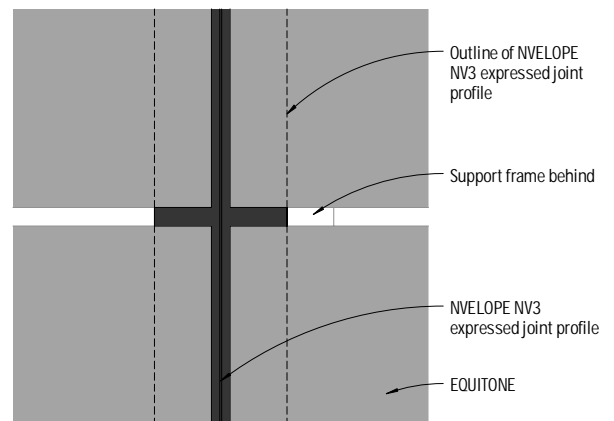

Figure 4: Open horizontal joint junction
with vertical joint - Elevation

Notes

- 1) In open horizontal joint design visible part of the support frame and weather barrier may be coated black with suitable paint.
- 2) The length of NVELOPE NV3 vertical and horizontal support frame, and expressed joint profile must NOT exceed 3,150mm.

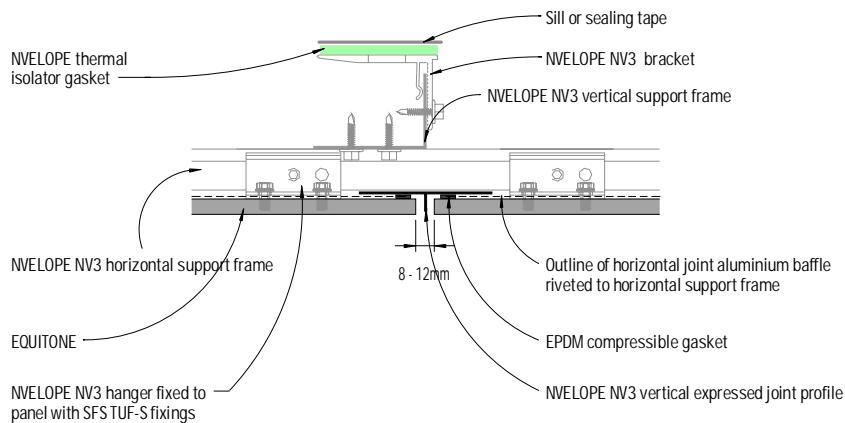

Figure 5: Vertical joint - Detail 1

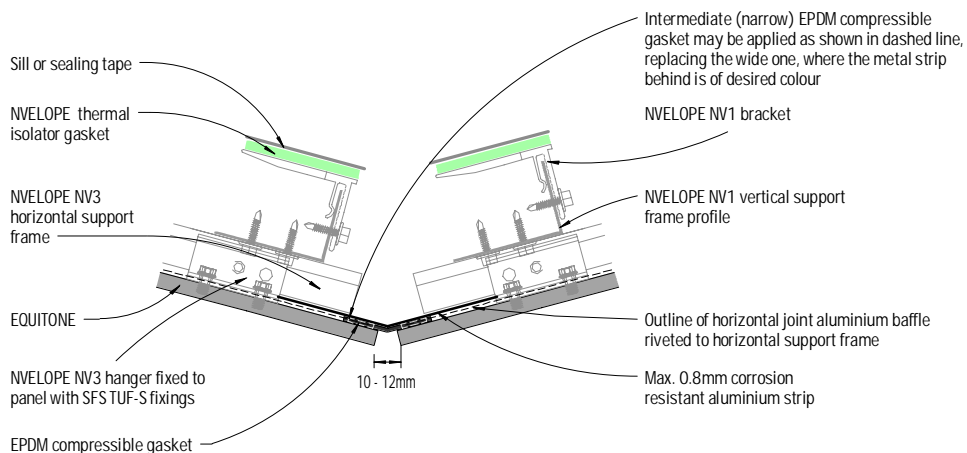

Figure 6: Vertical joint - Detail 2

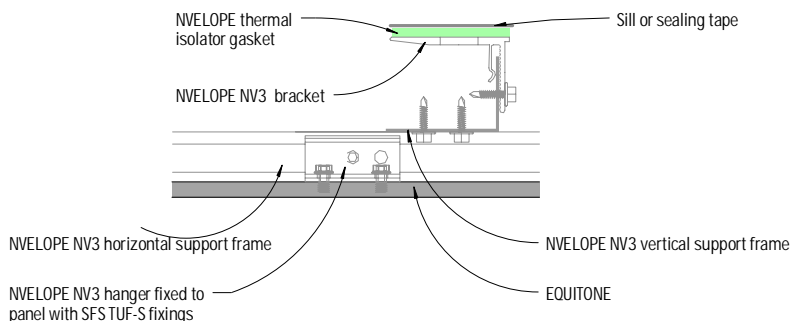

Figure 7: Intermediate panel fixing connection

Notes

- 1) The deflection of NVELOPE NV3 vertical expressed joint profile (as included in Figure 5) and any aluminium strip located at the vertical joint (as included in Figure 6) shall be limited to an extent ensuring the seal along the vertical joint is maintained with respect to project wind loading.
- 2) The aluminium strip should be fixed ONLY to one of the support frame profiles (either left or right) where allowance for horizontal and/or vertical movement of the cladding frame is required.

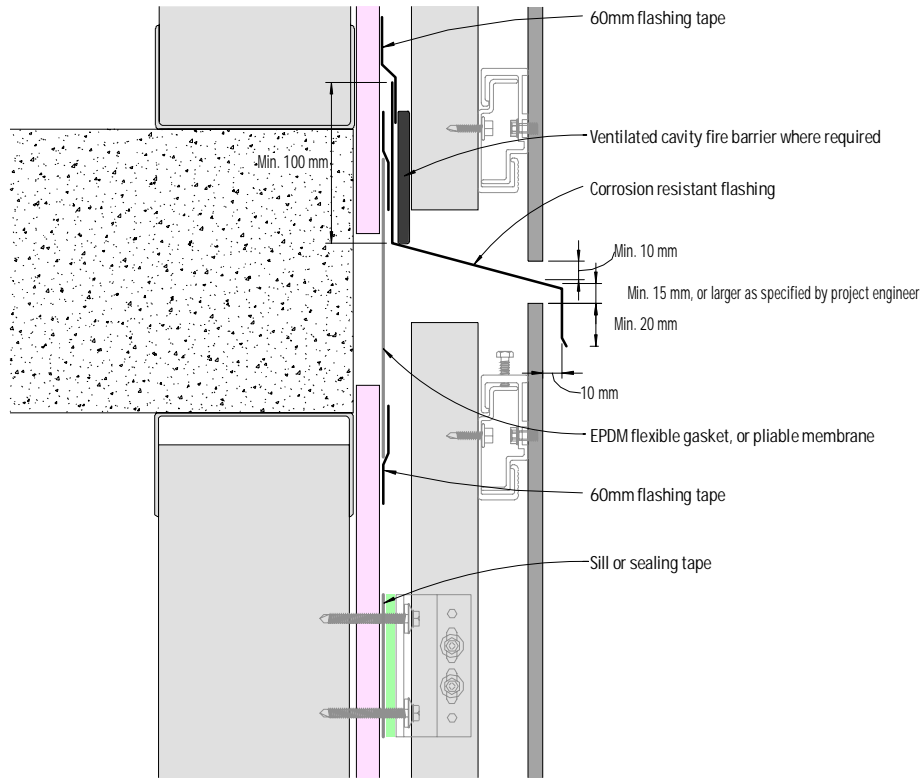

Figure 8: Horizontal control joint - Detail 1

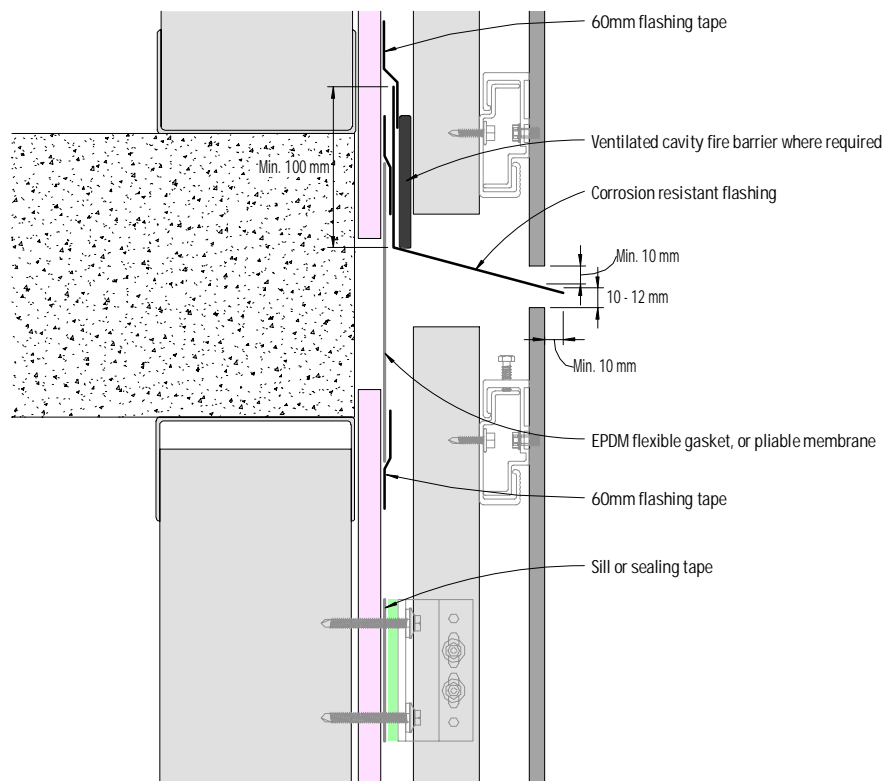

Figure 9: Horizontal control joint - Detail 2

Notes

- 1) Support frame profiles and Siniat Weather Defence must NOT be fixed crossing over a control joint nor to a deflection head.
- 2) Allowance for movement at the location of any control joint must be made in the cladding and its support frame design and installation. Panel must NOT be fixed bridging over any control joint.
- 3) In Figure 9, should a larger gap be required under the inter-storey flashing, the weatherproofing performance of the detail shall be evaluated by project engineer.

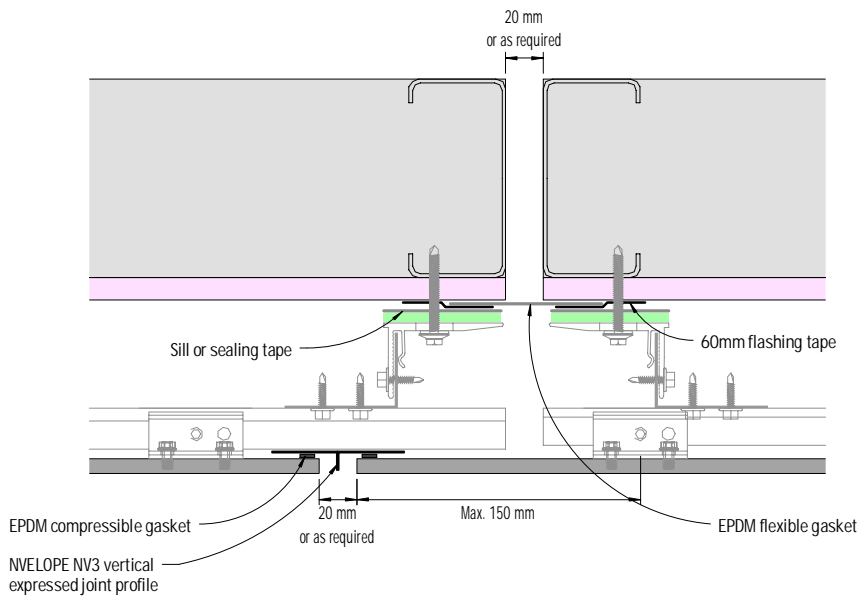

Figure 10: Vertical control joint

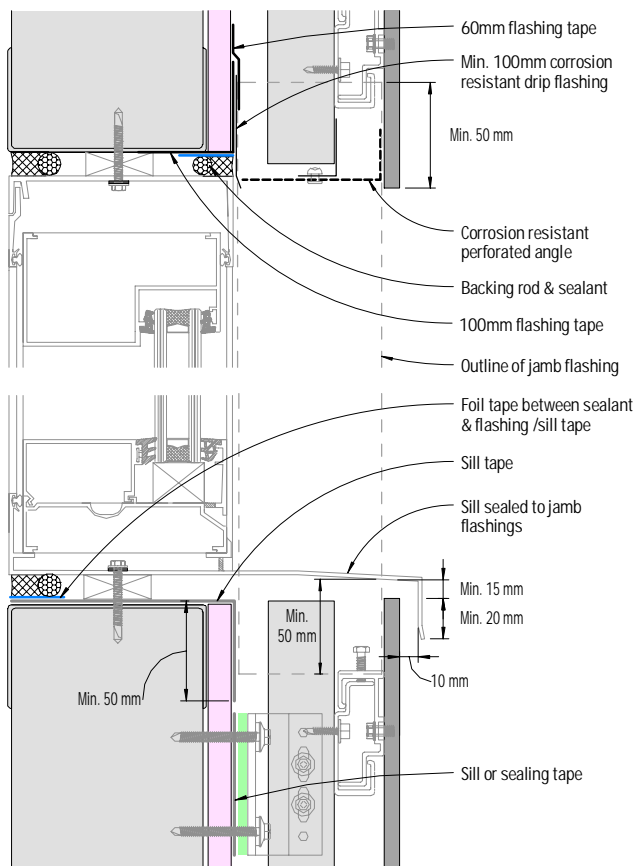

Figure 11: Window head and sill

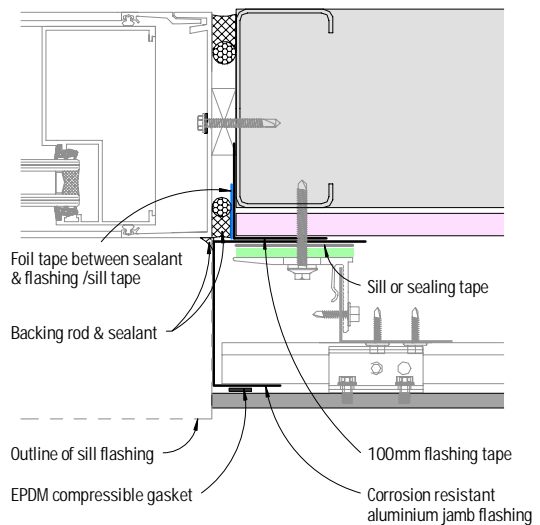

Figure 12: Window jamb

Notes:

- 1) Support frame profiles and Siniat Weather Defence must NOT be fixed crossing over a control joint nor to a deflection head.
- 2) The deflection of NVELOPE NV3 vertical expressed joint profile shall be limited to an extent ensuring the seal along the vertical joint is maintained with respect to project wind loading.
- 3) Allowance for movement at the location of any control joint must be made in the cladding and its support frame design and installation. Panel must NOT be fixed bridging over any control joint.
- 4) ONLY sealant compatible with the foil tape should be used. Should any sealant be intended to be used directly on the flashing and/or sill tape it must be confirmed with its manufacturer to ensure compatibility with these tapes in accordance with the relevant standards.

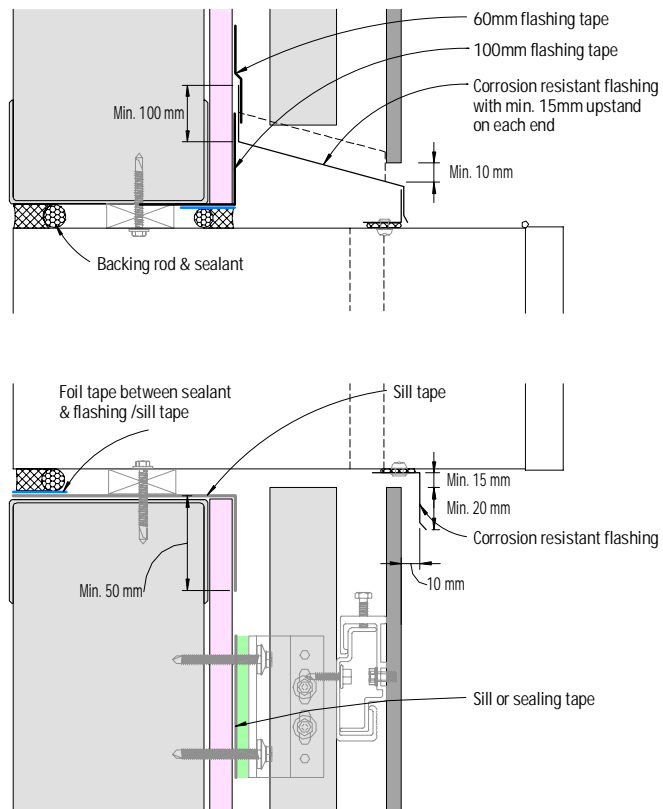

Figure 13: Meter box - Section

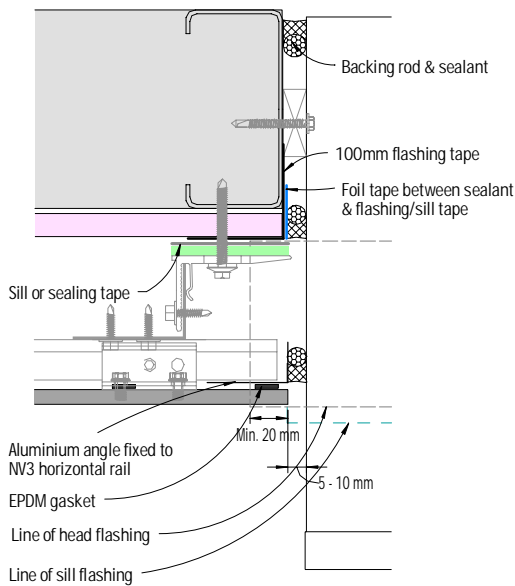

Figure 14: Meter box - Plan view - Detail 1

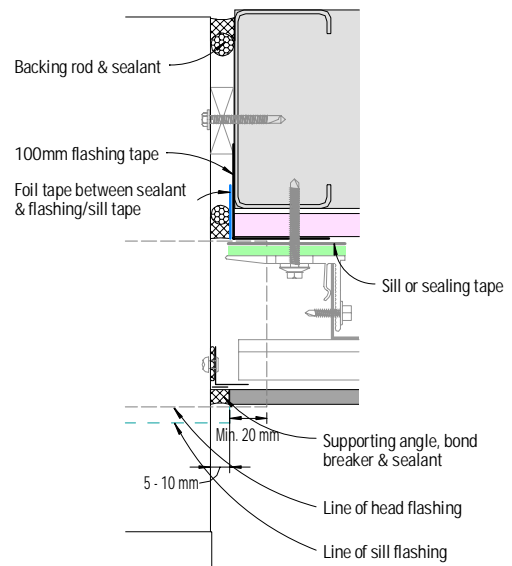

Figure 15: Meter box - Plan view - Detail 2

Note

ONLY sealant compatible with the foil tape should be used. Should any sealant be intended to be used directly on the flashing and/or sill tape it must be confirmed with its manufacturer to ensure compatibility with these tapes in accordance with the relevant standards.

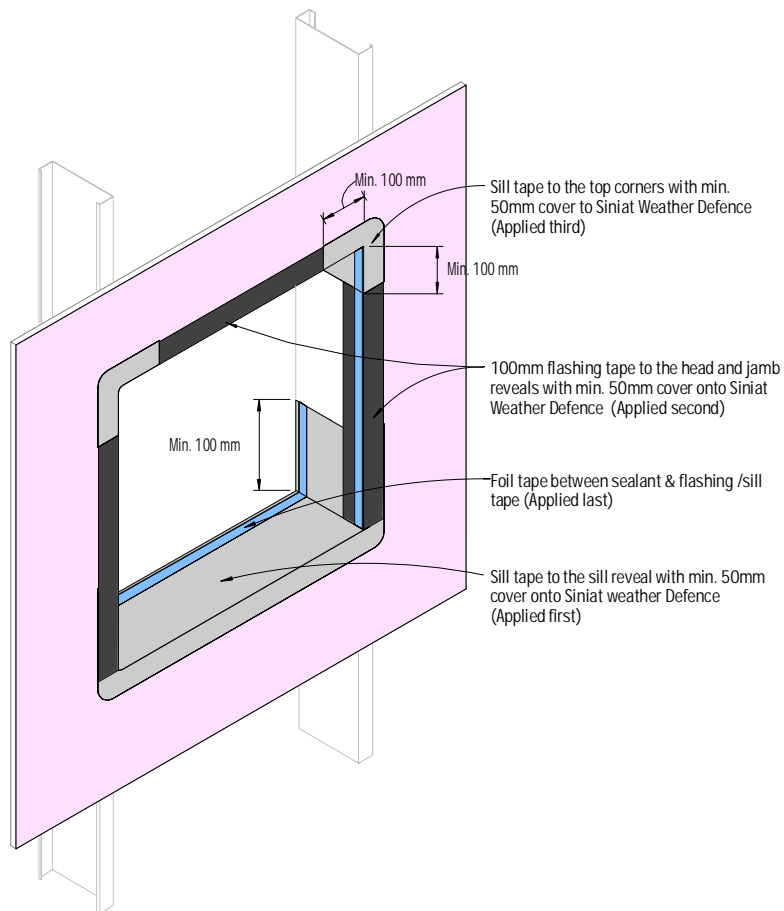

Figure 16: Isometric view of window/meter box opening - Tape application

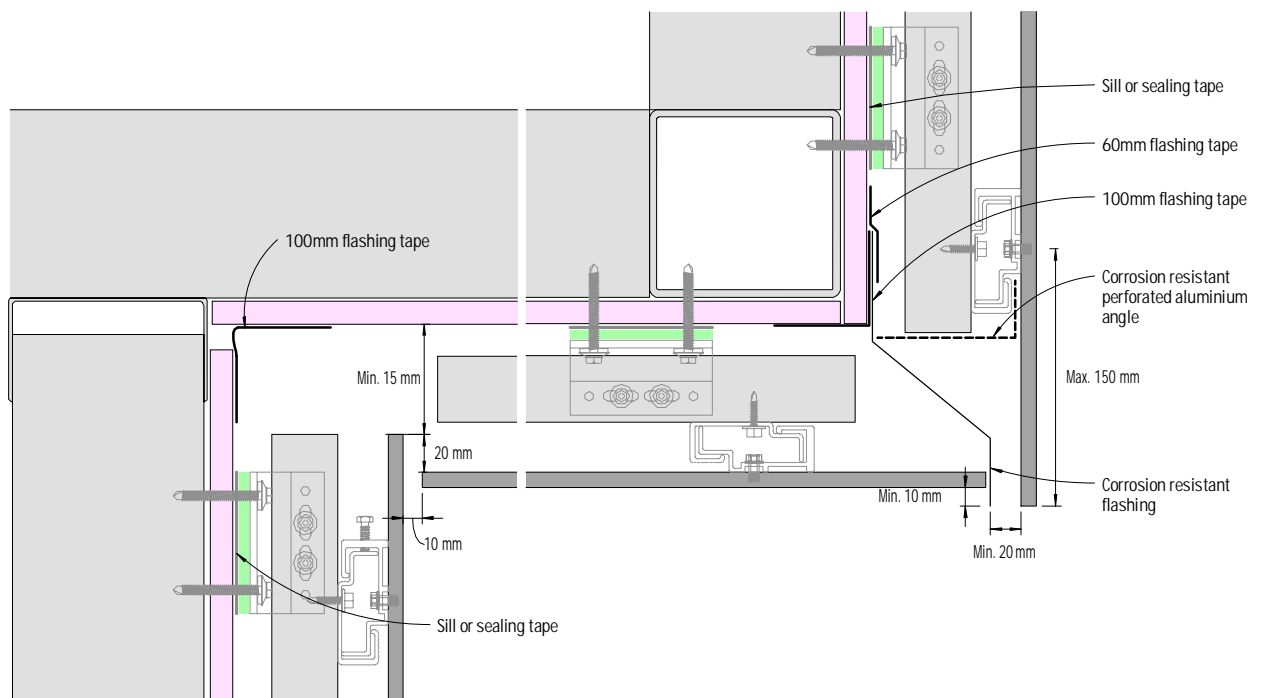

Figure 17: Soffit junction

Notes

- 1) ONLY sealant compatible with the foil tape should be used. Should any sealant be intended to be used directly on the flashing and/or sill tape it must be confirmed with its manufacturer to ensure compatibility with these tapes in accordance with the relevant standards.
- 2) Support frame profile and Siniat Weather Defence must NOT be fixed crossing over a control joint nor to a deflection head.
- 3) Corrosion resistant perforated angle shall be in Aluminium (or of adequate protective coating) to prevent bimetallic corrosion, be of max. thickness of 0.8mm where located between panel and support frame, and be of min. 50% open area.

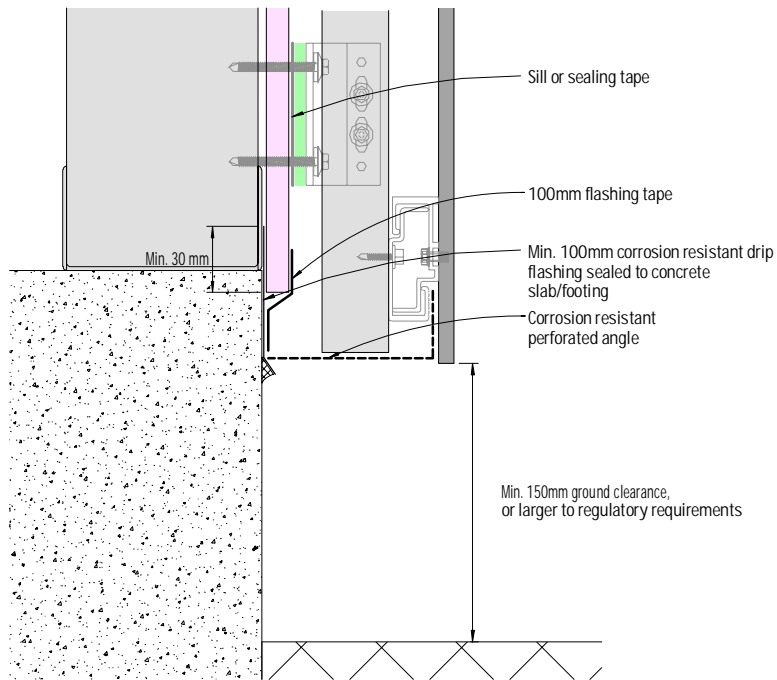

Figure 18: Base detail

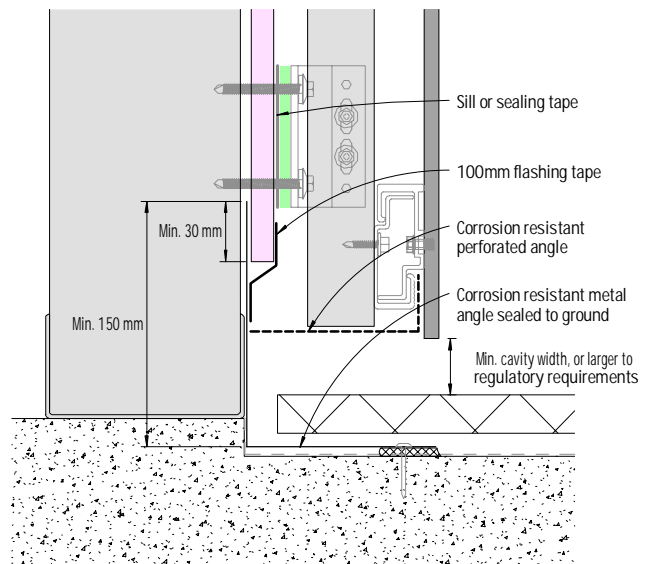

Figure 19: Base detail - Covered area

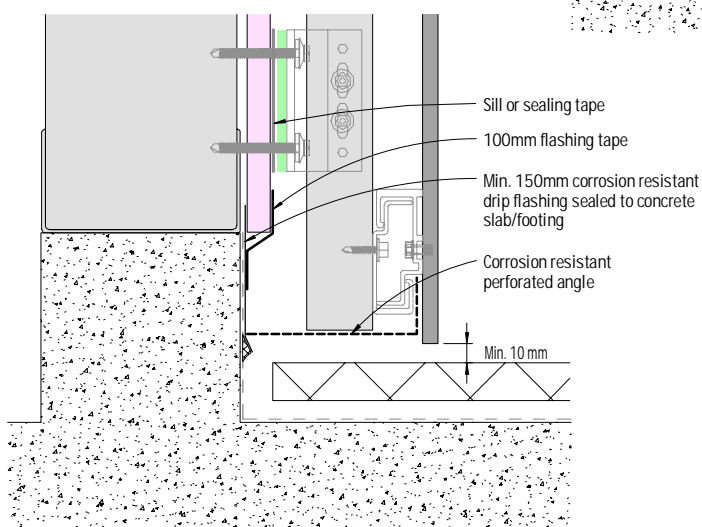

Figure 20: Base detail - Balcony

Notes

- 1) For **EQUITONE [materia]**, minimum ground clearance is **300mm**.
- 2) Corrosion resistant perforated angle shall be in Aluminium (or of adequate protective coating) to prevent bimetallic corrosion, be of max. thickness of 0.8mm where located between panel and support frame, and be of min. 50% open area.

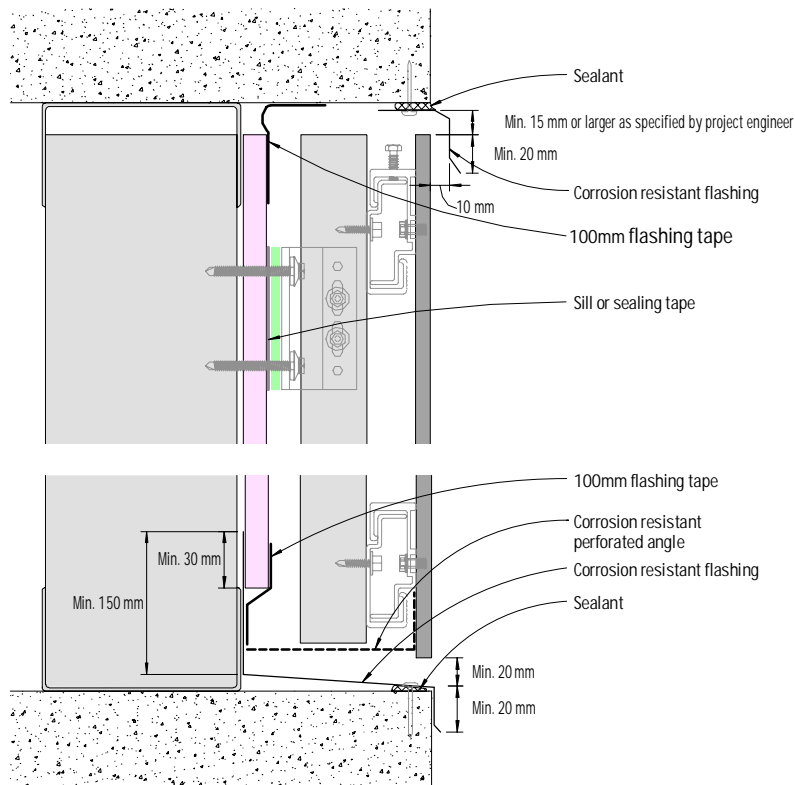

Figure 21: Exposed slab junction - Cladding flush

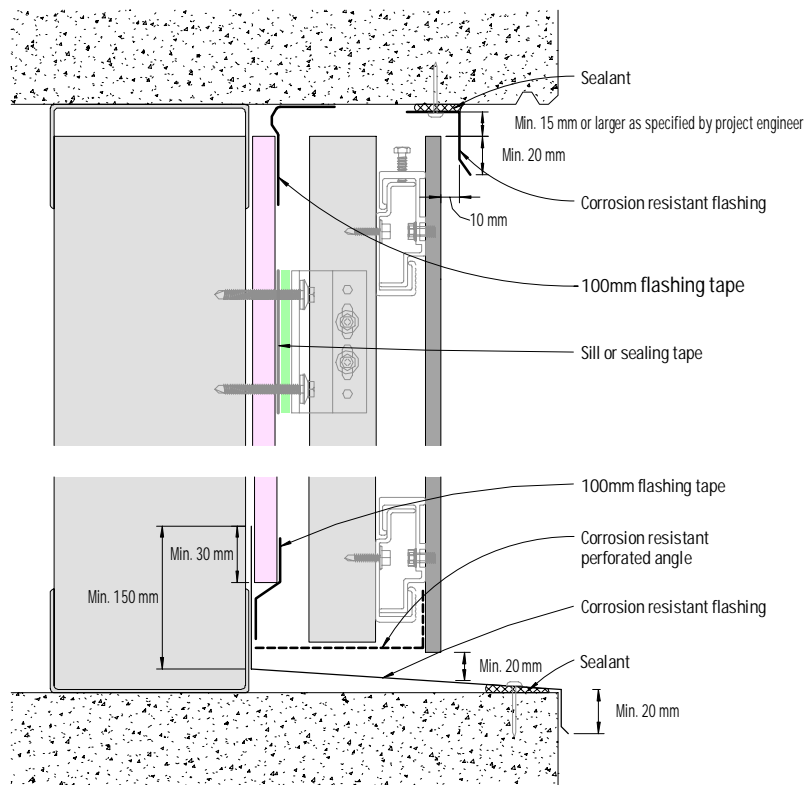

Figure 22: Exposed slab junction - Cladding recessed

Notes:

- 1) Refer to Pro Clima's flashing tape application guide for any pre-treatment required on concrete or masonry for the application of the flashing tape onto these substrates.
- 2) Support frame profiles and Siniat Weather Defence must NOT be fixed crossing over a control joint nor to a deflection head.
- 3) Corrosion resistant perforated angle shall be in Aluminium (or of adequate protective coating) to prevent bimetallic corrosion, be of max. thickness of 0.8mm where located between panel and support frame, and be of min. 50% open area.

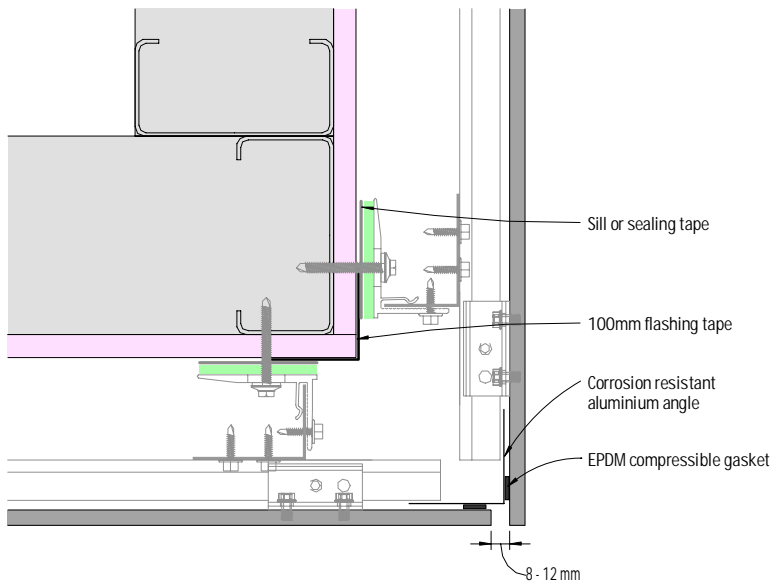

Figure 23: External corner

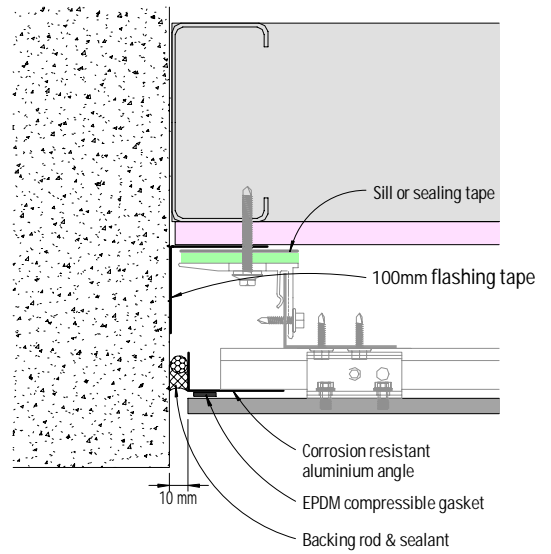

Figure 25: Abutment

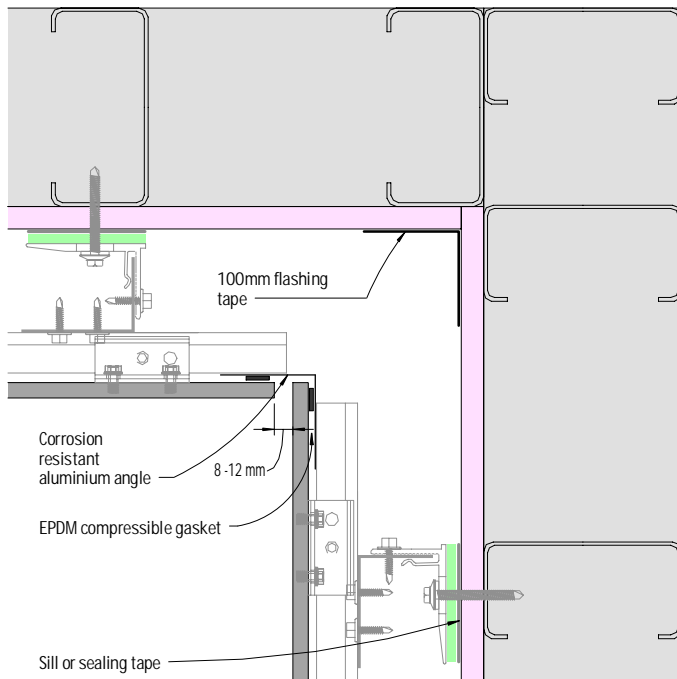

Figure 24: Internal corner

Note

The deflection of Aluminium angle located at the vertical joint of internal/external corner shall be limited to an extent ensuring the seal along the vertical joint is maintained with respect to project wind loading.

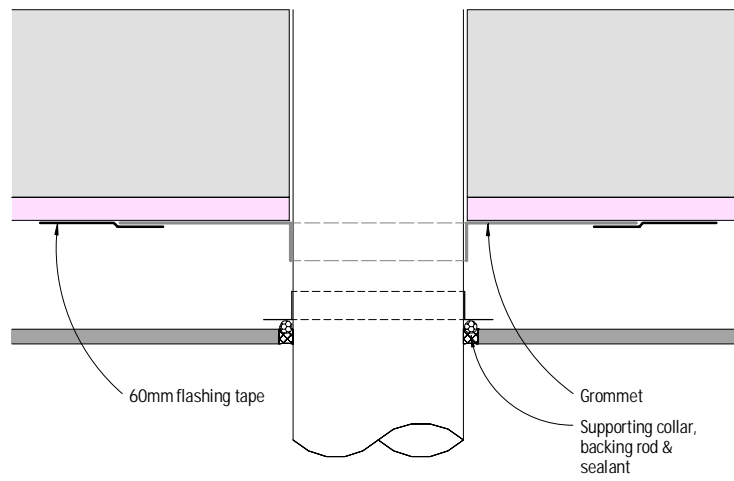

Figure 26: Pipe penetration - Plan view

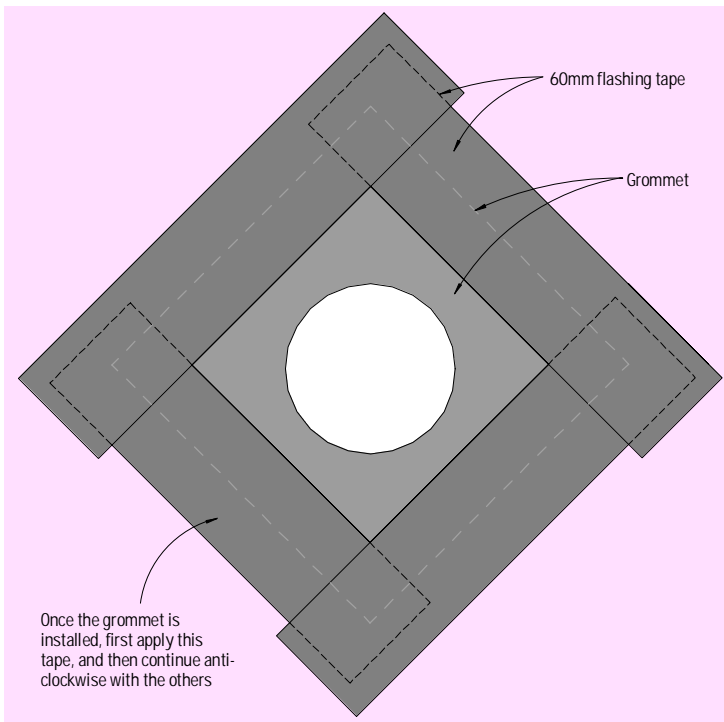

Figure 27: Pipe penetration - Elevation

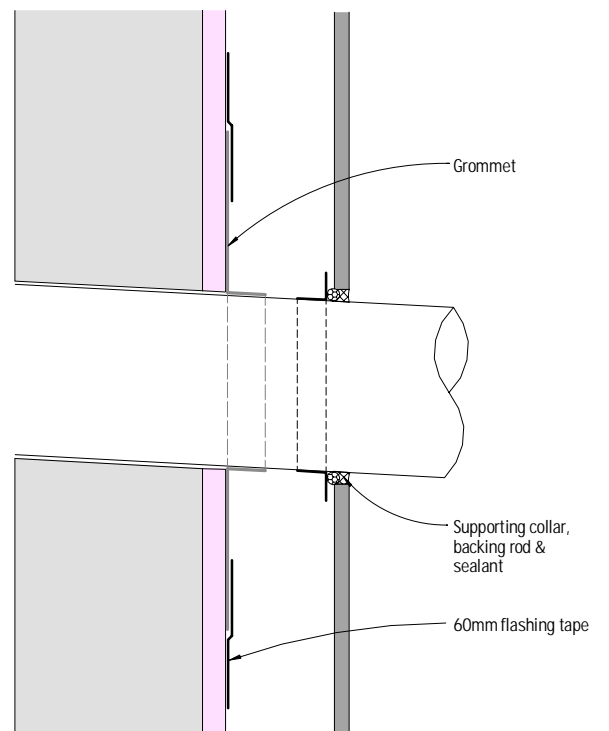

Figure 28: Pipe penetration - Section

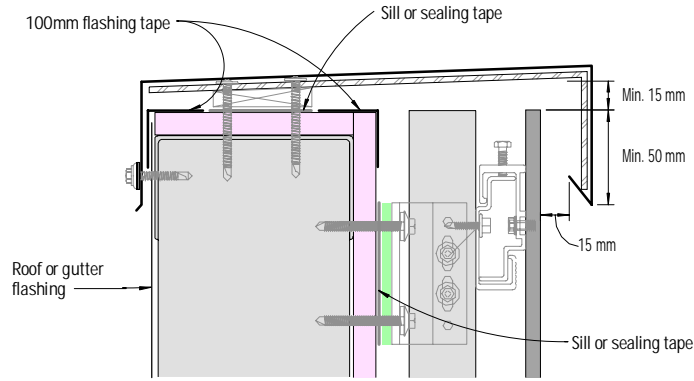

Figure 29: Capping - Detail 1

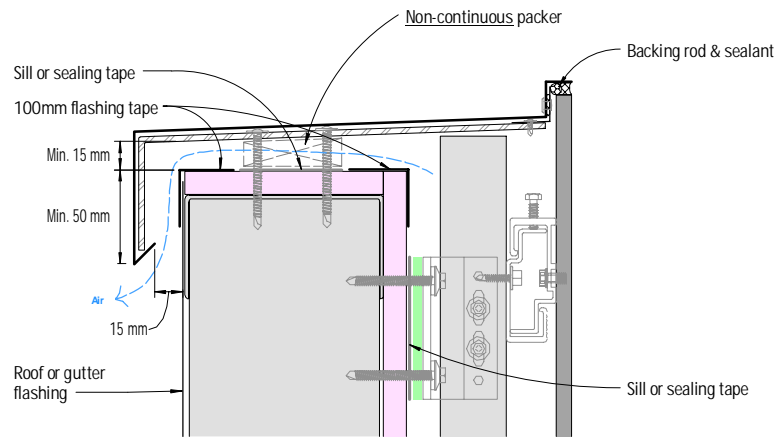

Figure 30: Capping - Detail 2

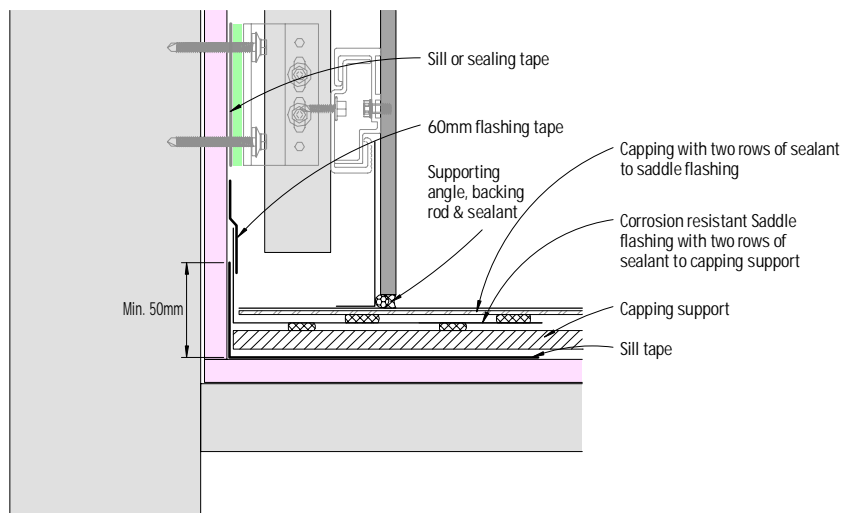

Figure 31: Parapet junction - Section

1) For EQUITONE [material], the following capping dimensions should be followed.

- A minimum 20mm between panel face and rear of the capping
- A minimum 50mm overlap with the panel for building up to 8m
- A minimum 80mm overlap with the panel for building up to 20m
- A minimum 100mm overlap with the panel for building over 20m

2) Capping detail '2' will involve further maintenance requirement in order to maintain the seal at the interface with the panel. Any deterioration of the sealant may result in panel staining, and will compromise the weatherproofing performance. Use UV stable and resistant external grade sealant

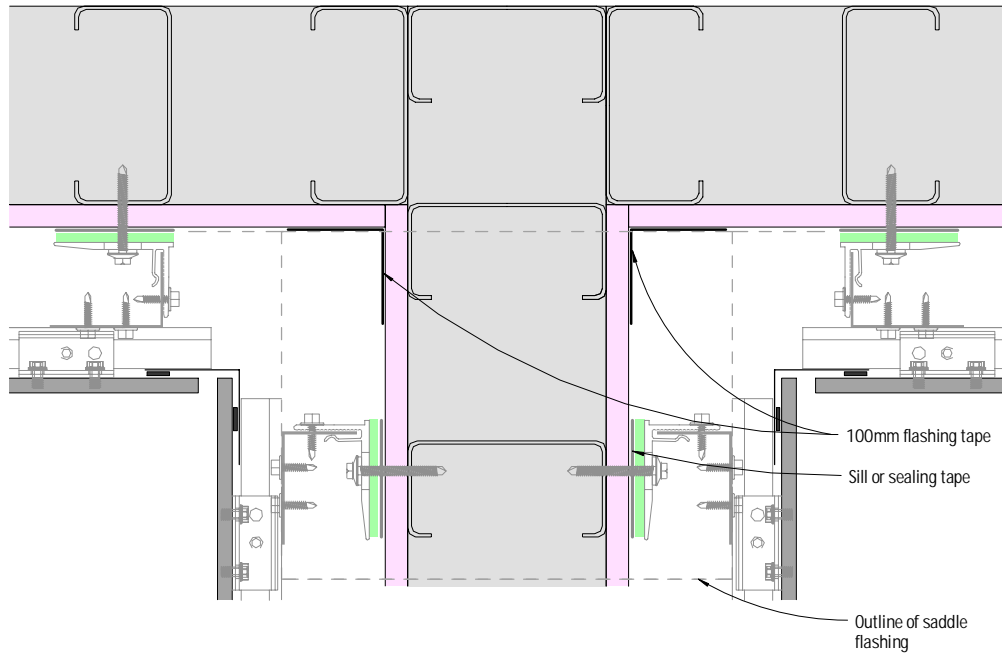

Figure 32: Parapet junction - Plan view

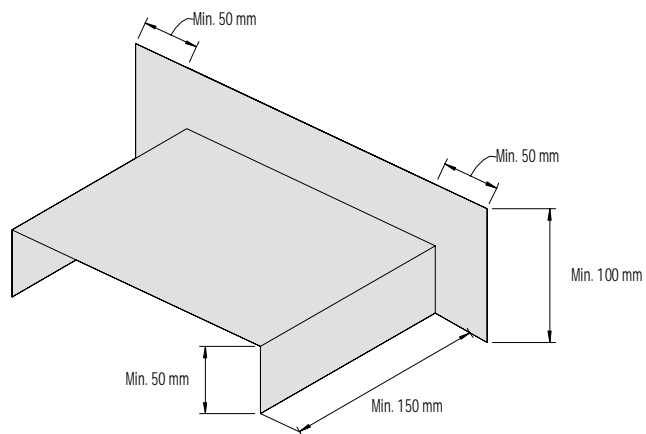

Figure 33: Corrosion resistant saddle flashing

EQUITONE system

Etex Exteriors ANZ
Suite 201
198 Harbour Esplanade
Docklands VIC 3008
Australia

+61 (03) 9988 2290
info.australia@equitone.com
equitone.com