



# ***Kalsi TextureBase*** Installation Guide



An industrial company with a proven history and a promising future

What we do

Improving our customers' quality of living with ever more effective lightweight solutions.

**Building Performance**  
Leader in plasterboards and fibre cement boards, and the global reference in passive fire protection solutions for the residential and commercial segments.

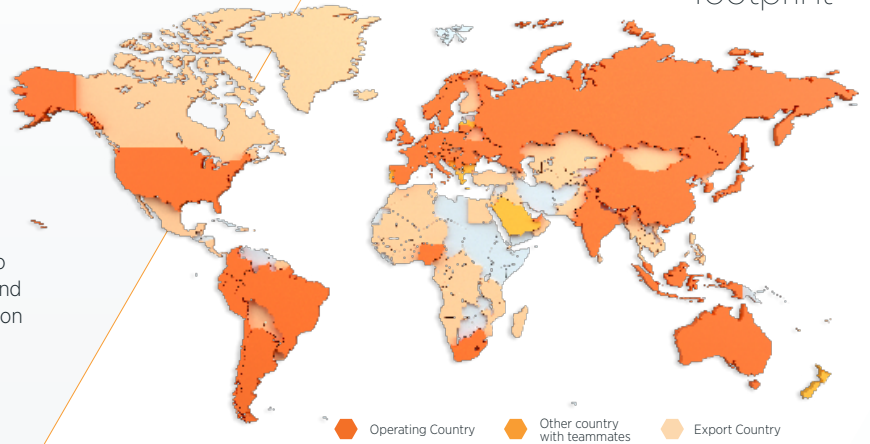
**Exteriors**  
Provider of innovative, durable, high performance and beautiful fibre cement exterior materials for architectural, residential and agricultural projects.

**Industry**  
Front runner of engineering expertise to drive the future of high performance thermal and acoustic insulation as well as passive fire protection in the industrial, aerospace and energy sectors.

**Insulation**  
Leading European insulation provider of glass mineral wool and extruded polystyrene (XPS) to insulate residential and non-residential buildings.

**New Ways**  
New Ways offers high-tech, lightweight, factory-assembled panel and modular solutions based on timber and steel framing.

Strong manufacturing global footprint



>140  
Sites: plants, quarries, offices.

45  
Operating countries

>13,500  
Teammates

Our main Commercial Brands

**CEDRAL**

**DURLOCK**

**EQUITONE**

**Eternit**

**Gyplac**

**Kalsi**

**PLADUR**

**Promat**

**siniat**

**Superboard**

**URSA**

Inspiring ways of living

**Our why**  
We want to inspire people around the world to build living spaces that are ever more safe, sustainable, smart and beautiful.

**Our how**  
We work as one, fostering a collaborative and caring culture, a pioneering spirit and a passion to always do better for our customers.

**Our what**  
Building on our experience and global market needs, we strive to improve our customers quality of living with ever more effective lightweight solutions.

Over a century of sustainable profitable growth



# Contents

About Kalsi TextureBase _____	4
Kalsi TextureBase Technical specifications & General properties _____	5
Scope of limitations _____	6
Working with Kalsi TextureBase _____	7
Design specifications _____	10
Board installation _____	12
Installation details _____	19
Finishing _____	24
Health & Safety _____	26

# Kalsi TextureBase

Kalsi TextureBase sheet is a robust pre-sealed fibre cement board for application of monolithic render or proprietary texture coat systems.

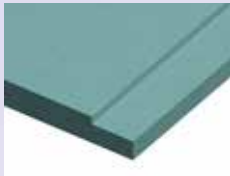
Kalsi TextureBase is a lightweight yet durable board that offers exceptional dimensional stability, superior fire performance and years of functional service.

Available with two or four recessed edges, Kalsi TextureBase allows perfect flat flushed joints, as it is a reliable and stable board.

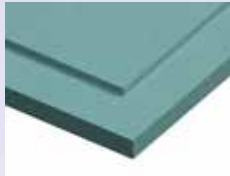
## Benefits

- Flexibility: Kalsi TextureBase is easy to cut, nail and work. It is very easily installed over timber sub-constructions.
- Complies with AS3959:2018 up to BAL-29 (Construction of buildings in bushfire prone areas).
- Built in Kalsi WaterBlock Technology.
- Flat finishes: Available with two or four\* recessed edges, Kalsi TextureBase helps the builder to achieve flat rendering coatings.

\*Four recessed edges available as special order only.



Two recessed edges



Four recessed edges



## Kalsi TextureBase Technical Specifications

### Dimensions

Length (mm)	Width (mm)	Thickness (mm)	Weight (kg/m <sup>2</sup> )
2440	1200	7.5	10.65
2725	1200	7.5	10.65
3000	1200	7.5	10.65

\*12mm thick special order only

## Kalsi TextureBase General Properties

### General Technical Properties

Dimensional Conformity (tested to AS/NZS 2908.2)		Pass
Length	mm	± 8
Width	mm	± 5
Thickness		± 10%
Straightness of edges	mm/m	3
Squareness of edges	mm/m	4
Density (tested to AS/NZS 2908.2)	kg/m <sup>3</sup>	≥1250
Modulus of rupture (tested to AS/NZS 2908.2) (Type A . Category 3)	MPa	≥7
Water permeability (tested to AS/NZS 2908.2)		Pass
Moisture content (tested to ASTM C1185)		≤15%
Water absorption (tested to ASTM C1185)		≤33%
Moisture movement (tested to ASTM C1185)		≤0.04%
Thermal conductivity (tested to ASTM C518-76)	W/m <sup>2</sup> K	0.27

### Durability

Warm water performance (tested to AS/NZS 2908.2)	Pass
Freeze-thaw performance (tested to AS/NZS 2908.2)	Pass
Soak-dry performance (tested to AS/NZS 2908.2)	Pass
Heat-rain performance (tested to AS/NZS 2908.2)	Pass

### Reaction To Fire

Combustibility (EN13501-1+A1)	A1 Non-Combustible
Surface spread of flame (tested to BS 476 Part 7)	Class I
Fire propagation index (tested to BS 476 Part 6)	I = 1.6
Fire Hazard Properties (tested to AS/NZS 1530.3)	
Ignitability Index	0
Spread of Flame Index	0
Heat Evolved Index	0
Smoke Developed Index	0-1

# Scope of Limitations

## Scope of Use

- Base carrier board for application of render or proprietary texture coating systems.
- On new that comply with the National Construction Code of Australia (NCC) or existing buildings where the designer and installer are satisfied that the existing building is suitable for the intended building work.
- On timber or light gauge steel-framed buildings.
- On vertical flat surfaces
- With aluminium and wood window joinery that is installed with vertical jambs and horizontal heads and sills.

## Limitations

- Specification and installation must be in accordance with the Kalsi TextureBase Installation Guide.
- Kalsi TextureBase must not be installed on timber framing where the moisture content is greater than 18%. We recommend using seasoned or kiln-dried timber framing.
- Consult with suppliers of waterproof membranes, tile adhesive, paint and render; texture coatings that selected products are compatible with Kalsi TextureBase.



# Working with Kalsi TextureBase

## Accessories

- Cavity batten.
- L corner flashing.
- Reinforced angle corner bead (uPVC or stainless steel corner).
- Vermin closing/Ventilated cavity base closer.
- Vapour permeable membrane.
- Nail (Min. 2.4 x 30mm fibre cement nail).
- Backing rod.
- Bond breaker tape.
- Paintable exterior grade polyurethane joint sealant.
- Jointing tape 50mm, alkali-resistant fibreglass mesh.
- External jointing compound.
- Skim coat.
- Texture coat.
- Vacuum extraction with HEPA filter.
- Dust-reducing saw.
- Fibre cement blade.



# Working with Kalsi TextureBase

## Site Work

### Loading and unloading

Kalsi TextureBase cement boards are usually supplied on pallets suitable for forklift. If crane offloading by slings is envisaged, special notification must be made in advance or upon placing orders.

All pallets and crates can be safely handled by using a barge lift or hoisting equipment and straps. Steel cables should not be used as it will damage both the pallet and the boards within.

When the crates have to be removed from a box container, care must be taken NOT to expose crates or pallets to the shock of any impact, as the shock could result in cracks in the boards.

### Transport to site

Always drive the delivery vehicle as close as possible to the location where the boards are to be installed. When transporting the boards, it is essential to firmly secure the pallets to prevent the boards from sliding or moving while in transit.

### Storage

Kalsi TextureBase fibre cement boards are supplied with protective plastic sheeting wrapped around the timber crates. This protection should not be removed until site and structural conditions are prepared and ready for board installation.

All Kalsi TextureBase fibre cement boards must be stored flat on pallets and placed inside in covered and dry conditions, optimising protection for stored boards against exposure to weather and other unfavourable conditions.



**Figure 1**  
Protective Plastic Sheeting

### Handling of Kalsi fire cement boards

The following must be taken into consideration when handling Kalsi TextureBase fibre cement boards.



**Figure 2**  
Whenever possible, lift the board from the stack below rather than slide board or drag off the stack. This will prevent damage by scratches to the lower board.



**Figure 3**  
Always carry the board on edge but DO NOT store on edge

### Kalsi Cavity Batten handling

The following must be taken into consideration when handling Kalsi cavity battens.



**Figure 4**  
Never carry Kalsi cavity batten on flat and middle position, as this increases likelihood of breakage.



**Figure 5**  
Hold the Kalsi cavity batten vertically at the edge.



# Working with Kalsi TextureBase

## Cutting Kalsi TextureBase Cement Boards

Kalsi TextureBase fibre cement boards offer easy workability with conventional tools, on or off construction sites. The method of cutting is dependent on the amount of cutting. Cutting of the board can be achieved using stationary table saws, circular saw and jigsaws. Cutting must take place in a dry environment. Dust control is required.

It is recommended that fibre cement saw blades (see figure 6) are used to cut the boards on site. These blades have been designed especially for fibre cement and when correctly employed, a high level of finish can be achieved. The blade is uniquely designed with vibration damping composite body construction and diamond tipped teeth shaped to give a tear-free edge.

When small amounts of cutting are required on site, an alternative to the recommended fibre cement saw blade is a carbide-tipped flat trapezoidal tooth blade. This has limited life and will need regular changing.



**Figure 6**  
Fibre cement blade.

## Drilling Kalsi TextureBase Cement Boards

Kalsi TextureBase fibre cement boards should be drilled using preferred and more efficient tungsten carbide tipped drills with point angles of 60° to 80° rather than the usual 120° type.

## Forming Holes

The following procedures serve as general guidelines when creating holes.

- For smooth, clean cut circular holes:
- Mark the centre of the hole on the board,
- Pre-drill a hole to be used as a guide,
- Cut the hole to the required diameter using a hole saw bit fitted to an electric drill where the centrifugal bit is inserted into the pre-drilled hole.

For small irregular holes:

- Small rectangular apertures can be achieved by drilling a series of small holes (using a drilling machine) around the perimeter of the prescribed opening.
- Carefully tap out the waste piece from the board face. Make sure that the edges are properly supported in order to avoid damage to the surrounding sheet.
- Rough edges can be smoothed with a rasp or at least 40 grit sand paper.

For large openings or apertures:

- Deeply score around the perimeter of the opening using a scoring knife.
- Form a large round hole in the centre using the method previously described.
- Saw cut from the centre towards the corners of the opening.
- Tap waste pieces from the face side and if necessary, clean rough edges with a rasp or at least 40 grit sand paper. Radius corners with a half round rasp to eliminate any stress points.

# Design Specifications

## Compliance

Designers and/or contractors responsible for the intended project should follow the details and recommendations specified in this manual.

It is also wise to keep in mind that all building design and construction should comply fully with the appropriate and relevant requirements of current legal building codes, regulations and standards, both domestic and international.

The information provided in this manual is valid at the time of publication. Please consult Kalsi or its nearest official representative for further versions or updates.

## Framing Considerations

The most common arrangement for the board's support is on to timber framing.

Kalsi TextureBase can be installed direct fixed or drained cavity systems based on respective building code compliance.

Minimum timber stud dimensions must be 35mm.

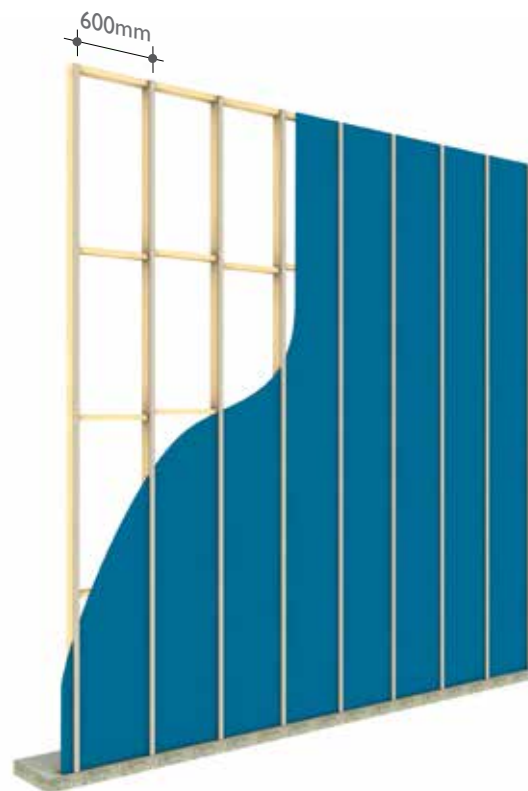
Ensure timber products are properly seasoned and dry before installation. Refer to AS 1684.2 – Residential Timber Frame Construction or the respective local standards compliance for the framing construction.

Always check that all framing is straight and true before receiving the boards.

Specific requirements for framing must be determined by a design engineer as per prevalent building codes prior to installation.



**Figure 7**  
Direct fix to framing method



**Figure 8**  
Drained cavity fixing method

# Design Specifications

## Moisture Management

Designers and/or contractors responsible for construction must ensure that building exteriors are appropriately waterproofed. This includes all wall openings, window sills, junctions and connections.

Selection of materials and installation needs to take into account the requirements of relevant standards and National Construction Code (NCC). It is always recommended that project specific details are undertaken by an experienced consultant with local knowledge of this specific field.

### Vapour Permeable Membranes

Building underlays must be installed in accordance with AS/NZS 4200.2 and material properties complying with AS/NZS 4200.1 or the equivalent local standards, codes and regulations.

In addition to the above, installation of the building underlay must also be in accordance with the manufacturer's recommendations.

### Flashing

Prior to fixing Kalsi TextureBase fibre cement boards, appropriate flashing and weatherproofing needs to be applied at critical points, such as:

- External corners
- Internal corners
- Window and door openings
- Penetration where pipes or wiring pass through the boards

## Wind Pressure

It is the responsibility of the designated project engineer to determine the relevant and specific wind pressures. All structural calculations must be achieved by following the relevant building codes. For the maximum capabilities of Kalsi TextureBase, please consult the Kalsi Technical Department.

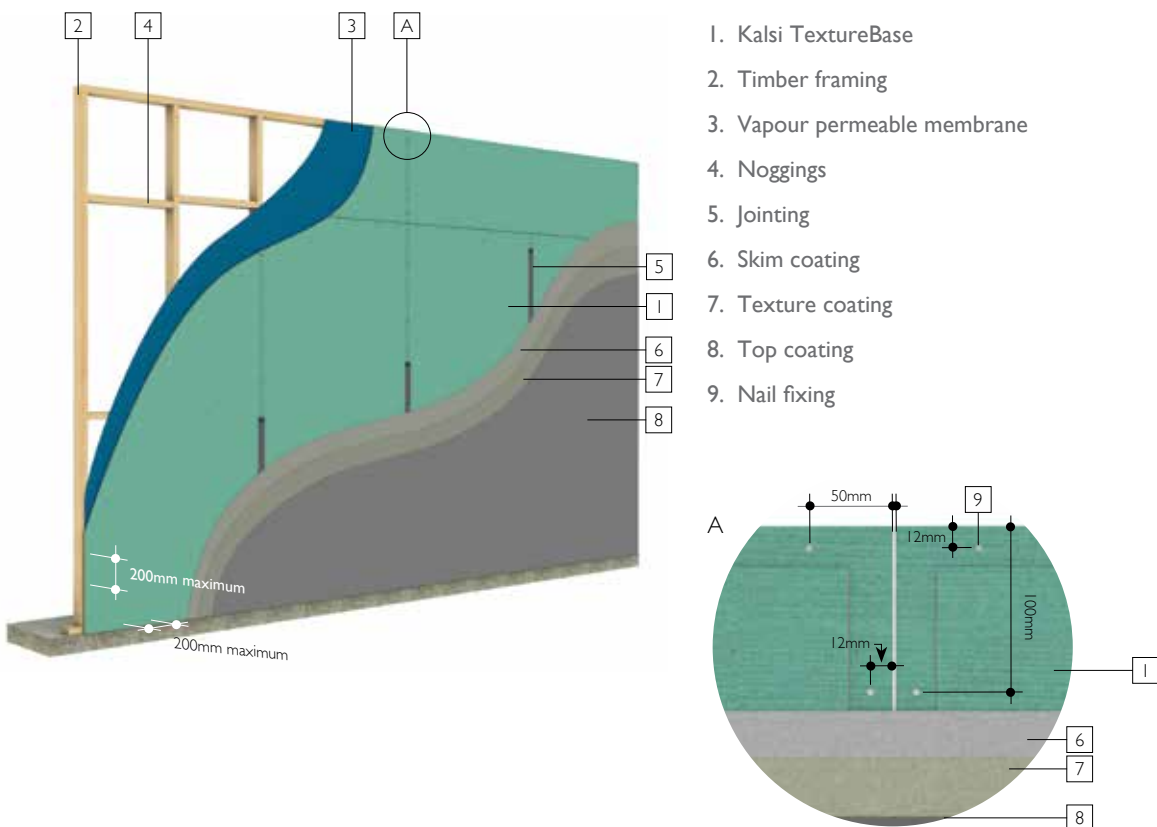
# Board installation

## Board Fixing

Kalsi TextureBase is recommended to be installed vertically with all board joints placed in staggered position when more than one sheet height is required. Kalsi TextureBase can also be positioned horizontally but only up to height of 1200mm, such as above and below openings or fascia.

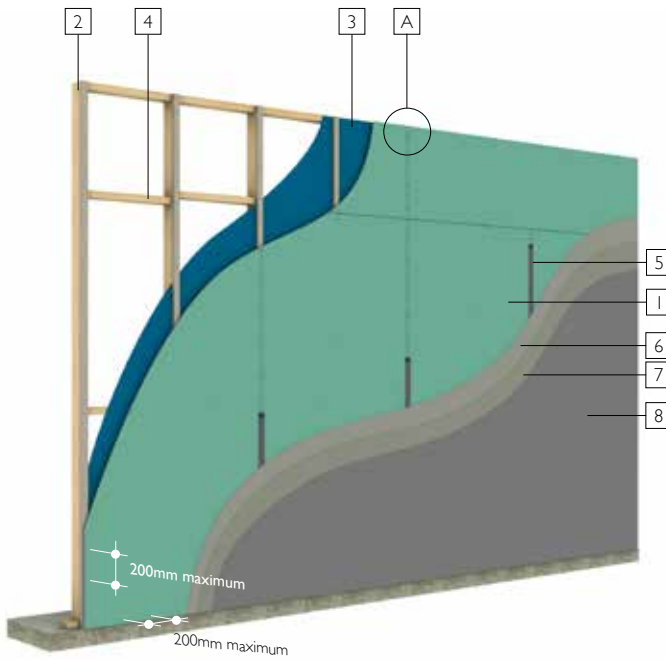
The layout of boards should be planned in advance to ensure that expected framing systems suit the board size. Whenever possible, use full width board to minimise the number of joints and board wastage. The boards must be positioned with its recessed edges adjacent to one another to create a cavity that will be filled with the texture coated fibre glass mesh tape. When a small board is required, the boards must have a minimum 200mm width with recessed edge located at the joint.

The maximum fixing distance cannot surpass 200mm centres. Any gaps between boards for vertical and horizontal joints must be filled with the base coat flushing compound before bedding in a 50mm wide alkaline resistant fibre glass mesh tape. Finish flushing the joints as per normal trade practice for fibre cement sheet. The coating manufacturers specifications (available on request) take precedence over other specifications.

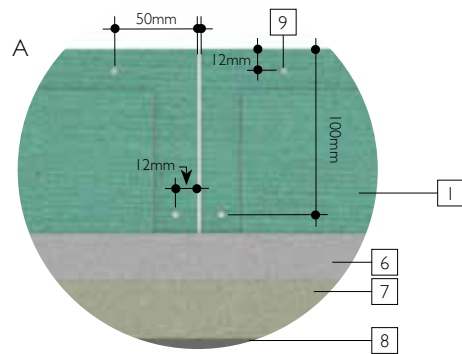


**Figure 9**  
Vertical board fixing for direct fixed

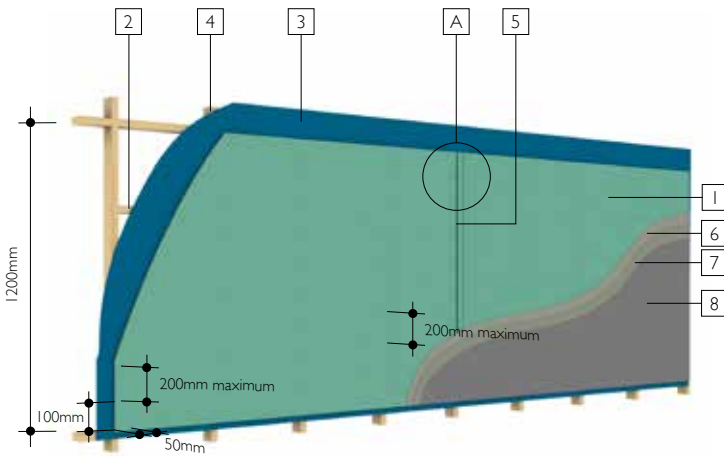
# Board installation



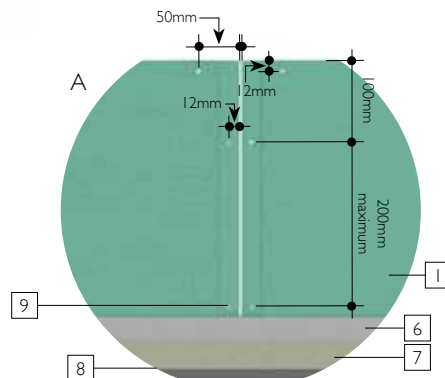
1. Kalsi TextureBase
2. Timber framing
3. Vapour permeable membrane
4. Noggings
5. Jointing
6. Skim coating
7. Texture coating
8. Top coating
9. Nail fixing



**Figure 10**  
Vertical board fixing for drain cavity systems



1. Kalsi TextureBase
2. Noggings
3. Vapour permeable membrane
4. Timber framing
5. Jointing
6. Skim coating
7. Texture coating
8. Top coating
9. Nail fixing



**Figure 11**  
Horizontal board fixing details

# Board installation

## Fixing Kalsi TextureBase

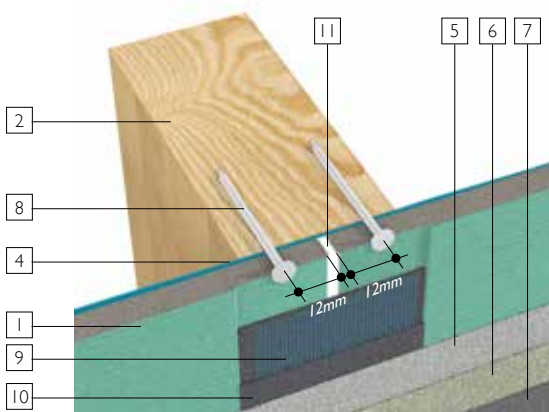
Consideration of fastener durability is influenced by material choice, environmental factors and compatibility of materials in contact with fasteners. In general, the fasteners of choice should be resistant to corrosion.

When Kalsi TextureBase is installed in coastal areas, Kalsi recommends the use of stainless steel fasteners or contact your fastener supplier for suitable corrosion resistant fasteners, especially within 1km of the coast or when local micro climatic conditions (exposure to salt environments, for example) require it.

Fastener is fixed using nails as in Table 1 and as per figure 12 and 13.

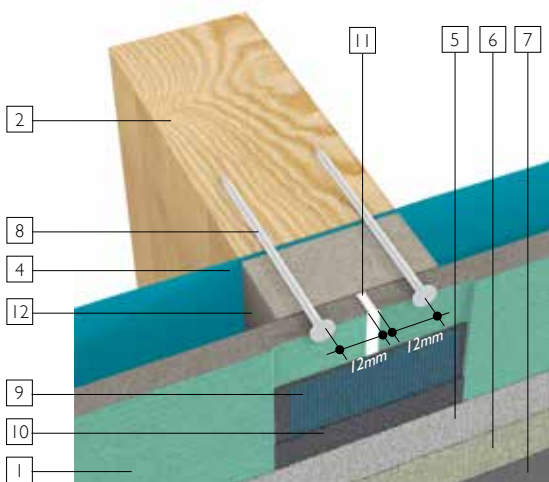
**Table 1: Nail Requirement**

Direct fix	30mm x 2.8mm Galvanized FC nails (or similar if fixing to steel stud)
Drained cavity	50mm x 2.8mm Galvanized FC nails (or similar if fixing to steel stud)



1. Kalsi TextureBase
2. Timber framing
3. Intermediate top hat
4. Vapour permeable membrane
5. Skim coating
6. Texture coating
7. Top coating
8. Nail fixing
9. Jointing tape
10. Jointing compound
11. Polyurethane joint sealant

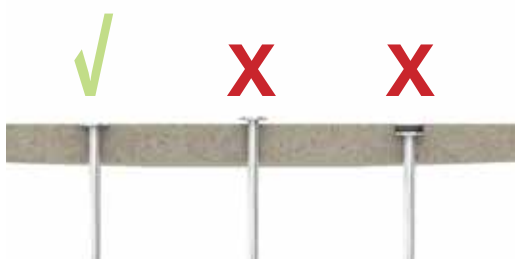
**Figure 12**  
Direct fix board jointing



1. Kalsi TextureBase
2. Timber framing
3. Intermediate top hat
4. Vapour permeable membrane
5. Skim coating
6. Texture coating
7. Top coating
8. Nail fixing
9. Jointing tape
10. Jointing compound
11. Polyurethane joint sealant
12. Cavity batten

**Figure 13**  
Drained cavity board jointing

Fasteners must be driven flush into the boards, as per figure 14.



**Figure 14**  
Nail fastener depth

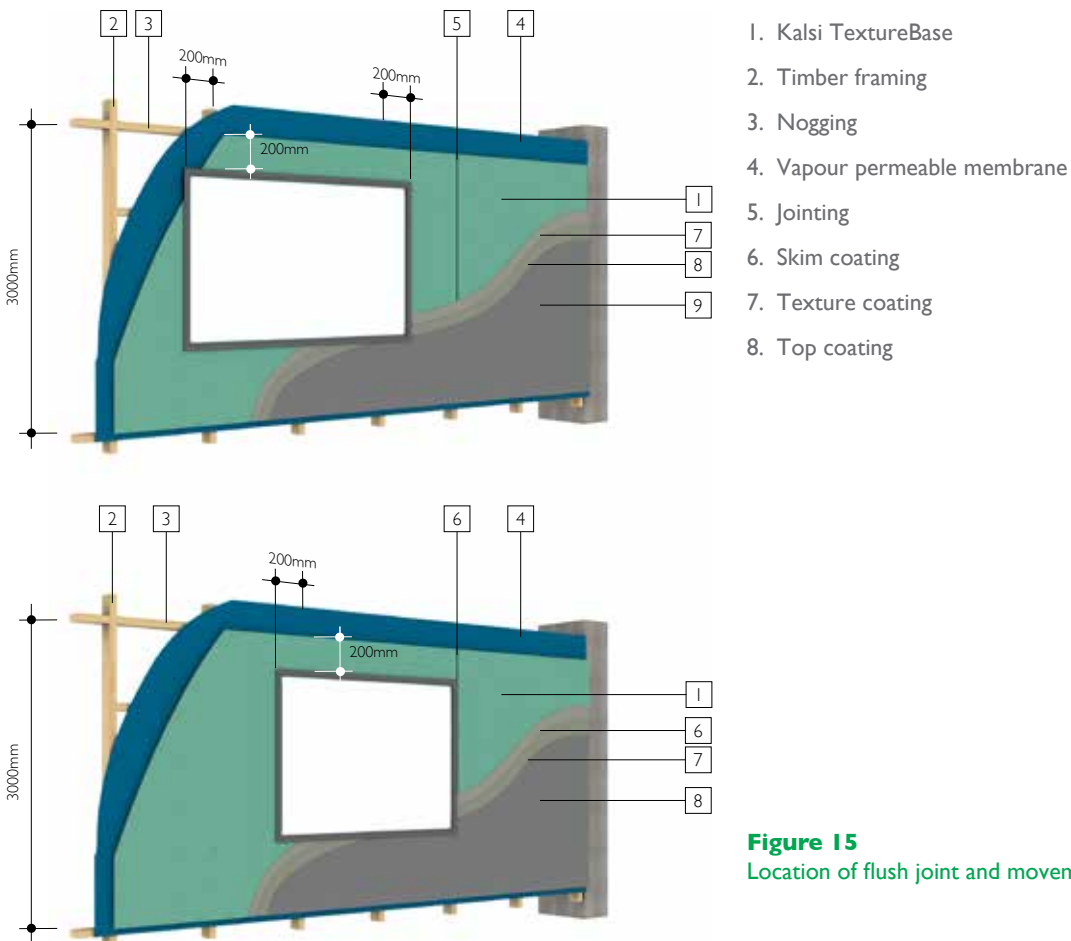
# Board installation

## Movement Joints

Although Kalsi TextureBase is dimensionally stable, it is however; recommended and important to include appropriate movement joints. This will help to prevent bowing, cracking or formation of peaks at joints due to contractions and expansions generated by thermal, moisture and structural variations. Movement joints must be correctly located so that they can work efficiently without compromising weathertightness of the cladding.

A range of different types of movement joints for use in construction are shown as follows:

- Horizontal and vertical movement control joints
- Structural joints
- Construction joints.

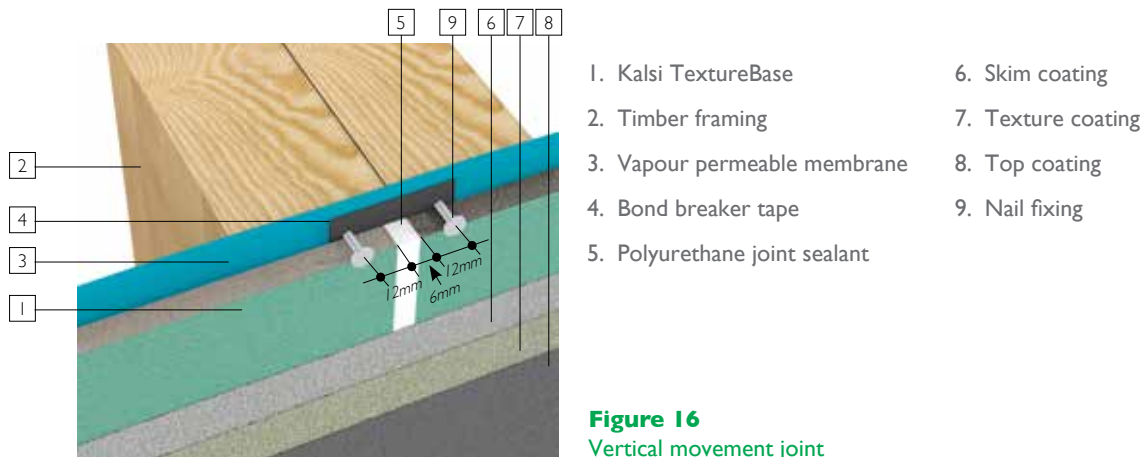


**Figure 15**  
Location of flush joint and movement control joint

# Board installation

## Vertical Movement Control Joints

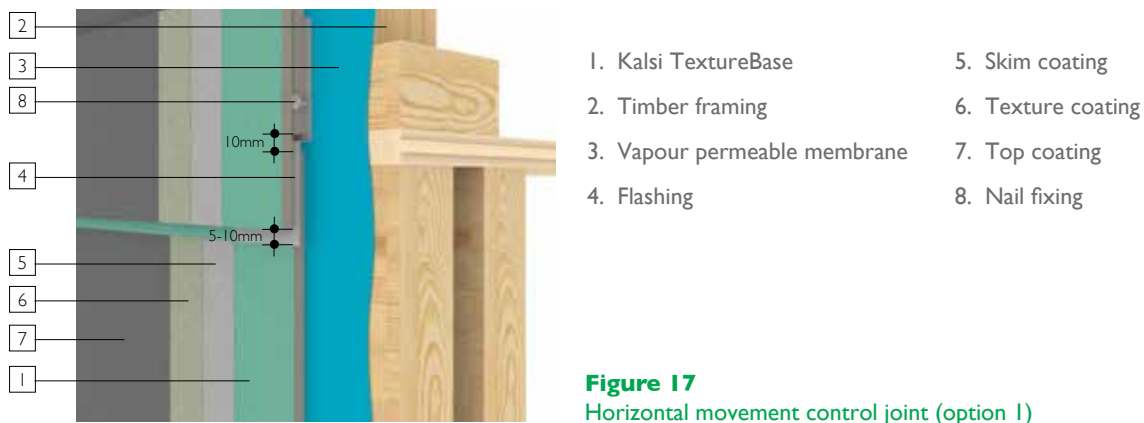
Vertical movement control joints are installed at 4.8 metres (maximum 5.4 metres) centres along the length of the wall or at the internal and external corners. Vertical movement control joints can also be constructed at the edges of windows and door openings. An opening of 6mm nominal must be provided between the joint and sealed with polyurethane joint sealant over bond breaker tape. See figure 16 for joint details.



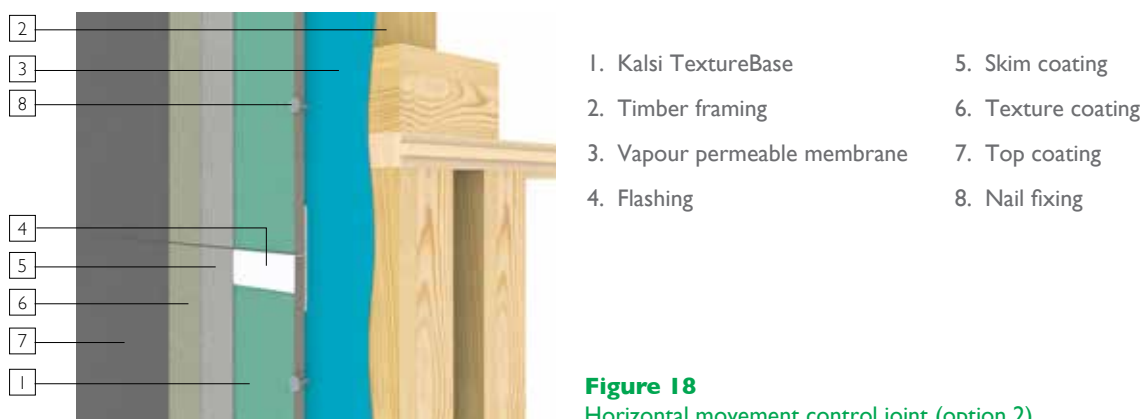
**Figure 16**  
Vertical movement joint

## Horizontal Movement Control Joints

It is equally important to consider the location within a structure of horizontal movement control joints. Inter-storey joints where boards cross the main structure of the first or subsequent floor are a good example of this building factor. These joints should be located at every floor, or to a maximum distance of three metres centres. See figure 17 and 18 for joints detail.



**Figure 17**  
Horizontal movement control joint (option 1)



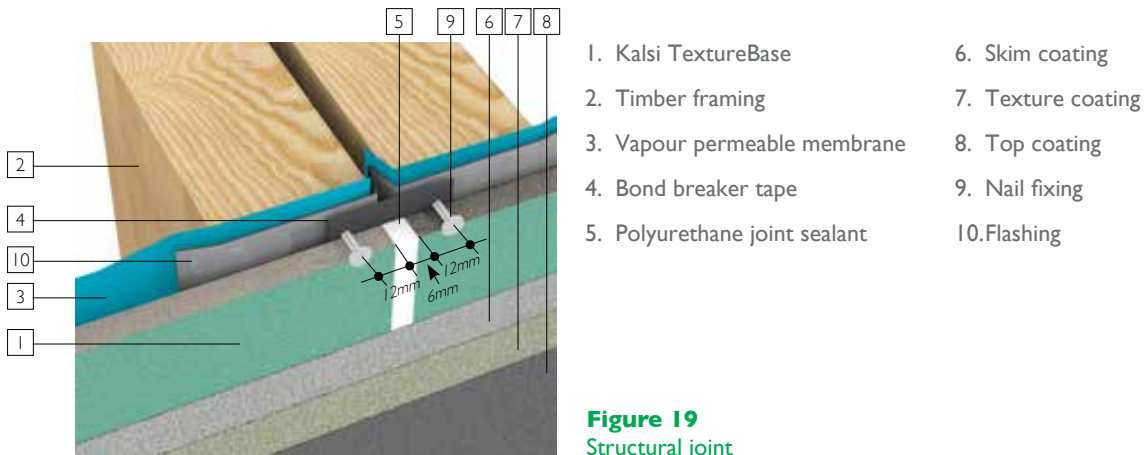
**Figure 18**  
Horizontal movement control joint (option 2)



# Board installation

## Structural Joints

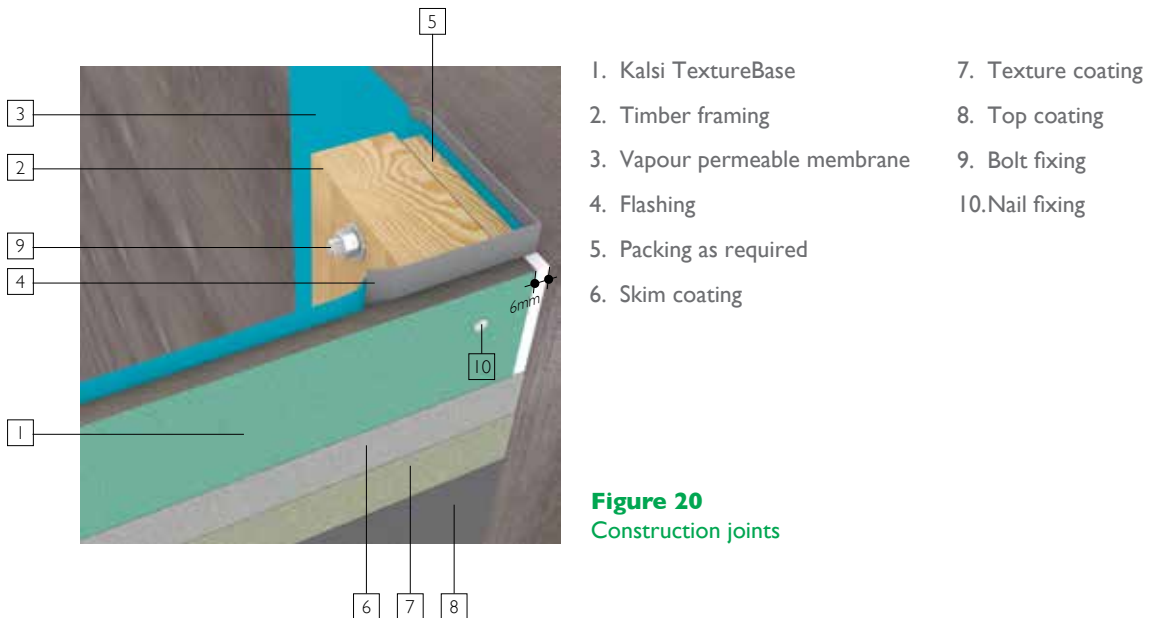
Two separate Kalsi TextureBase boards are fixed at the joint when there is a requirement for structural joints. See Figure 18 for structural joints details.



**Figure 19**  
Structural joint

## Construction Joints

Kalsi TextureBase can be used in conjunction with a range of other cladding materials, such as masonry veneer or concrete block. Figure 19 outlines the details of the construction joints.



**Figure 20**  
Construction joints

# Board Installation

## Layout Around Openings

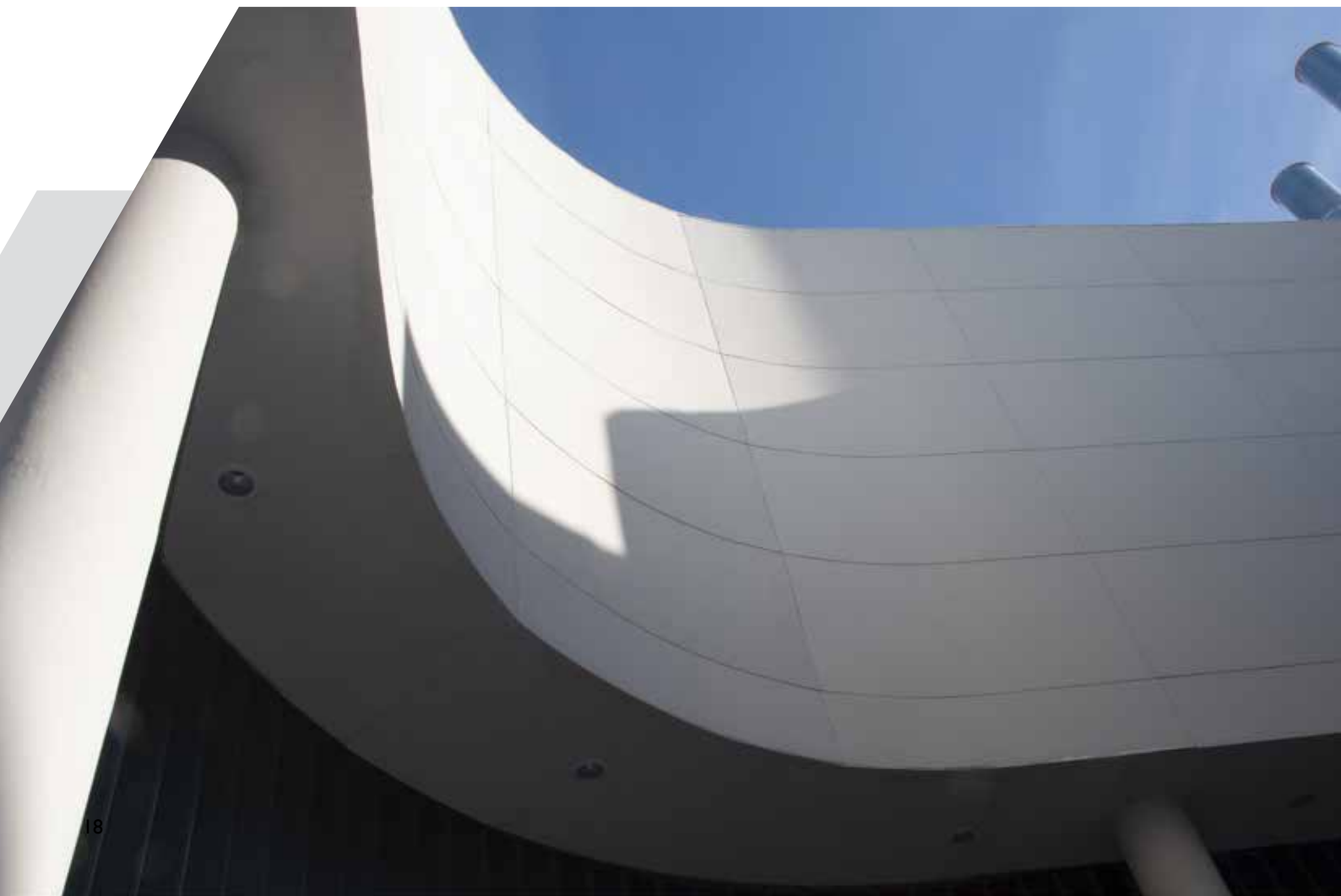
Care should be taken that no joints are located directly above the jamb of window or door openings unless constructed as a vertical movement control joint. The joint must be located at least 150-200mm in from the jamb, and away from any area of great stress. Please refer to figure 15 on page 15 illustrates two alternative constructions around the openings.

## Allowable Radii Of Curvature

Kalsi TextureBase boards are flat. However, it is possible to fit them around a curved façade. In this event, take note that orientation of the board is critical. A horizontal board bends easier than one placed vertically.

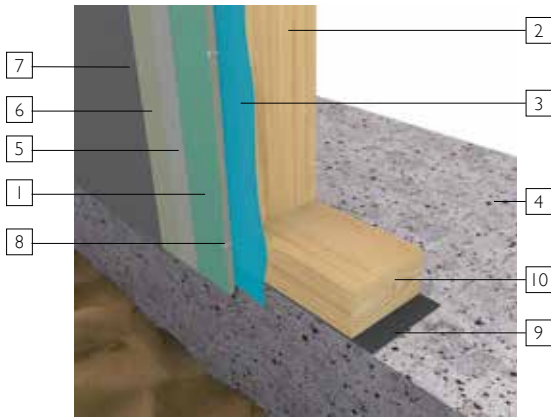
The minimum radius that Kalsi TextureBase can be fixed to a curving façade is 10m. The following table indicates maximum top hat spacing.

Curve Radii (m)	Maximum Top Hat Spacing (mm)
	Board width 1200mm
10m-15m	400
> 15m	600



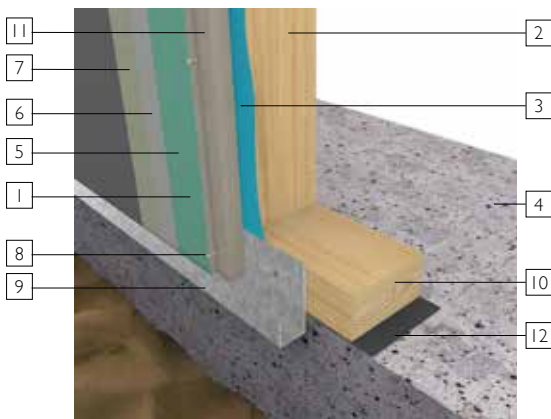
# Installation details

## Concrete Slab Details



- |                              |                        |
|------------------------------|------------------------|
| 1. Kalsi TextureBase         | 6. Texture coating     |
| 2. Timber framing            | 7. Top coating         |
| 3. Vapour permeable membrane | 8. Nail fixing         |
| 4. Concrete slab             | 9. Damp proof membrane |
| 5. Skim coating              | 10. Bottom plate       |

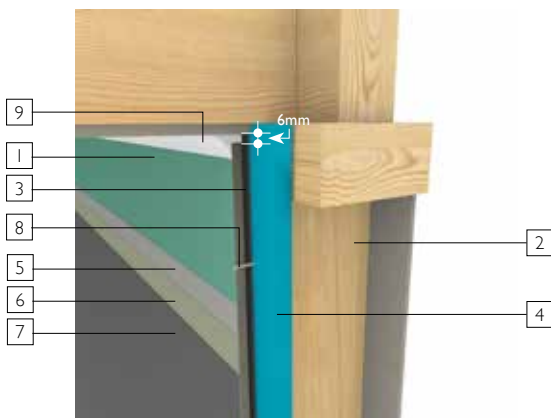
**Figure 21**  
Concrete slab details for direct fixed systems



- |                              |                                       |
|------------------------------|---------------------------------------|
| 1. Kalsi TextureBase         | 8. Nail fixing                        |
| 2. Timber framing            | 9. Vermin closing/cavity based closer |
| 3. Vapour permeable membrane | 10. Bottom plate                      |
| 4. Concrete slab             | 11. Cavity batten                     |
| 5. Skim coating              | 12. Damp proof membrane               |
| 6. Texture coating           |                                       |
| 7. Top coating               |                                       |

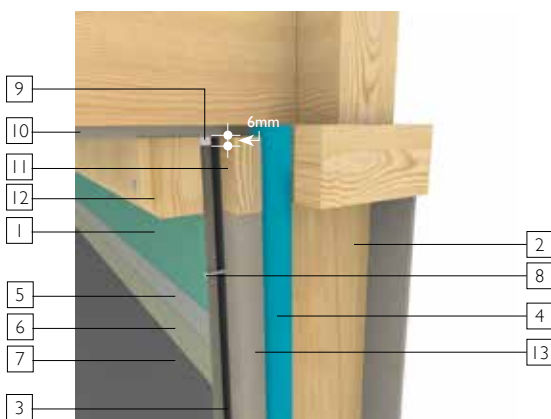
**Figure 22**  
Concrete slab details for cavity based closer systems

## Soffit/Wall Details



- |                              |                               |
|------------------------------|-------------------------------|
| 1. Kalsi TextureBase         | 6. Texture coating            |
| 2. Timber framing            | 7. Top coating                |
| 3. Bond breaker tape         | 8. Nail fixing                |
| 4. Vapour permeable membrane | 9. Polyurethane joint sealant |
| 5. Skim coating              |                               |

**Figure 23**  
Soffit/wall details for direct fixed systems



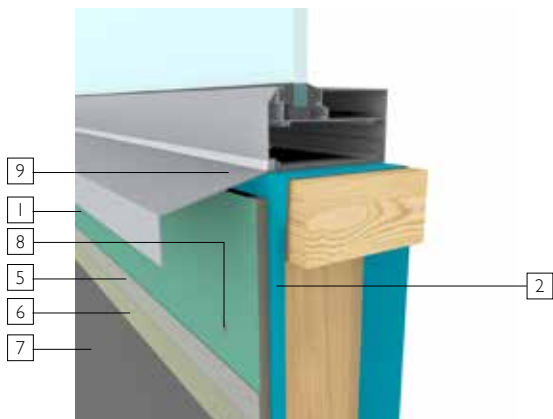
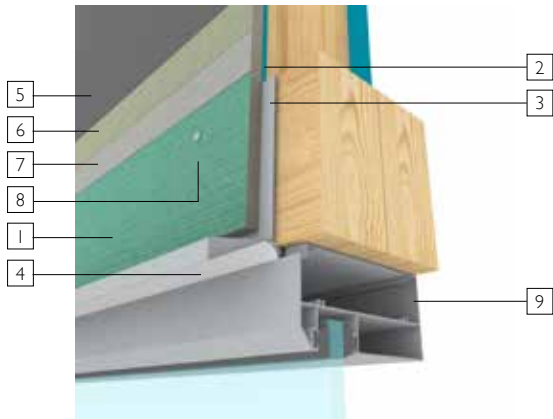
- |                              |  |
|------------------------------|--|
| 1. Kalsi TextureBase         | 8. Nail fixing                             |
| 2. Timber framing            | 9. Polyurethane joint sealant              |
| 3. Bond breaker tape         | 10. Soffit                                 |
| 4. Vapour permeable membrane | 11. Continuous packers                     |
| 5. Skim coating              | 12. Beading - alternative to sealant joint |
| 6. Texture coating           | 13. Cavity batten                          |
| 7. Top coating               |  |

**Figure 20**  
Soffit/wall details for cavity based systems

# Installation details

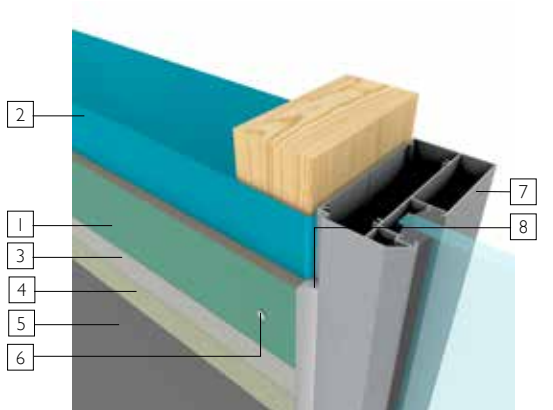
## Window Details

Direct fixed system



- |                               |                    |
|-------------------------------|--------------------|
| 1. Kalsi TextureBase          | 6. Texture coating |
| 2. Vapour permeable membrane  | 7. Top coating     |
| 3. Flashing                   | 8. Nail fixing     |
| 4. Polyurethane joint sealant | 9. Window framing  |
| 5. Skim coating               |                    |

**Figure 23**  
Window details - direct fixed system



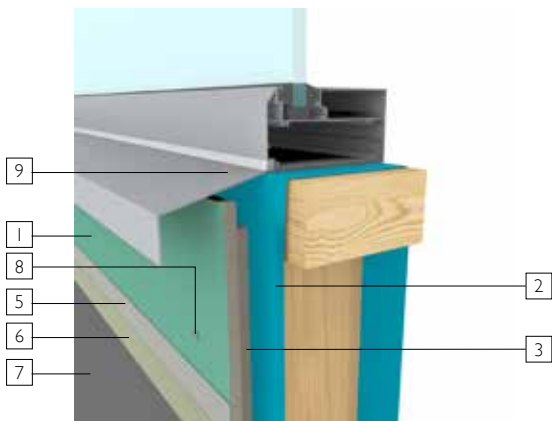
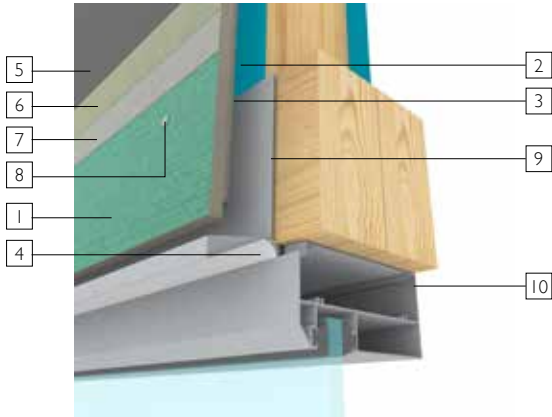
- |                              |                               |
|------------------------------|-------------------------------|
| 1. Kalsi TextureBase         | 5. Top coating                |
| 2. Vapour permeable membrane | 6. Nail fixing                |
| 3. Skim coating              | 7. Window framing             |
| 4. Texture coating           | 8. Polyurethane joint sealant |

**Figure 24**  
Window jamb details - direct fixed system

# Installation details

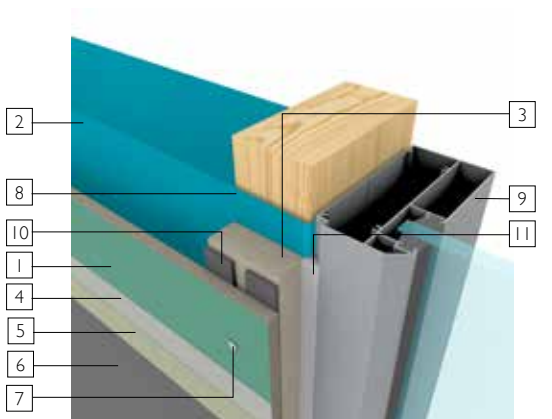
## Window Details

Drained cavity system



- |                               |                    |
|-------------------------------|--------------------|
| 1. Kalsi TextureBase          | 6. Texture coating |
| 2. Vapour permeable membrane  | 7. Top coating     |
| 3. Cavity batten              | 8. Nail fixing     |
| 4. Polyurethane joint sealant | 9. Window framing  |
| 5. Skim coating               | 10. Flashing       |

Figure 25  
Window details - drained cavity system

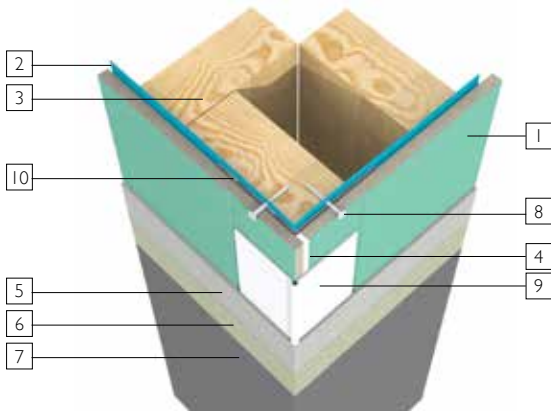


- |                              |                                |
|------------------------------|--------------------------------|
| 1. Kalsi TextureBase         | 7. Nail fixing                 |
| 2. Vapour permeable membrane | 8. Flashing                    |
| 3. Cavity batten             | 9. Window framing              |
| 4. Skim coating              | 10. Bond breaker tape          |
| 5. Texture coating           | 11. Polyurethane joint sealant |
| 6. Top coating               |                                |

Figure 26  
Window jamb details - drained cavity system

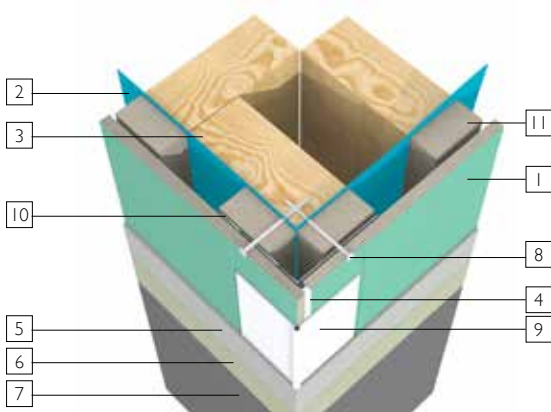
# Installation details

## External Corner



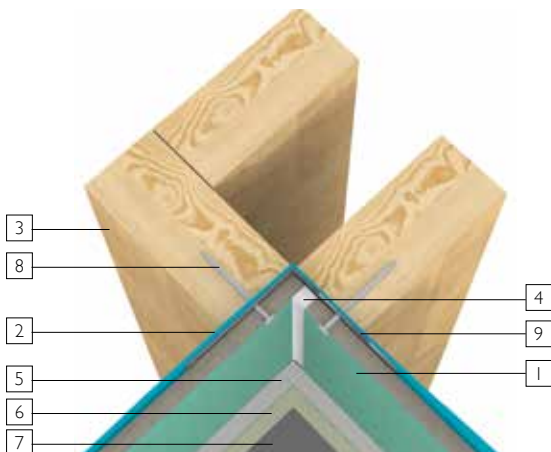
- |                               |                      |
|-------------------------------|----------------------|
| 1. Kalsi TextureBase          | 6. Texture coating   |
| 2. Vapour permeable membrane  | 7. Top coating       |
| 3. Timber framing             | 8. Nail fixing       |
| 4. Polyurethane joint sealant | 9. Angle corner bead |
| 5. Skim coating               | 10. Flashing         |

**Figure 27**  
External corners - direct fixed system



- |                               |                      |
|-------------------------------|----------------------|
| 1. Kalsi TextureBase          | 7. Top coating       |
| 2. Vapour permeable membrane  | 8. Nail fixing       |
| 3. Timber framing             | 9. Angle corner bead |
| 4. Polyurethane joint sealant | 10. Flashing         |
| 5. Skim coating               | 11. Cavity batten    |
| 6. Texture coating            |                      |

**Figure 28**  
External corners - drained cavity system

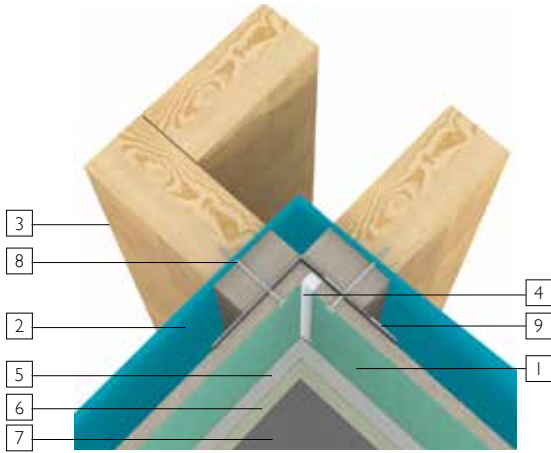


- |                               |                    |
|-------------------------------|--------------------|
| 1. Kalsi TextureBase          | 6. Texture coating |
| 2. Vapour permeable membrane  | 7. Top coating     |
| 3. Timber framing             | 8. Nail fixing     |
| 4. Polyurethane joint sealant | 9. Flashing        |
| 5. Skim coating               |                    |

**Figure 29**  
Internal corners - direct fixed system

# Installation details

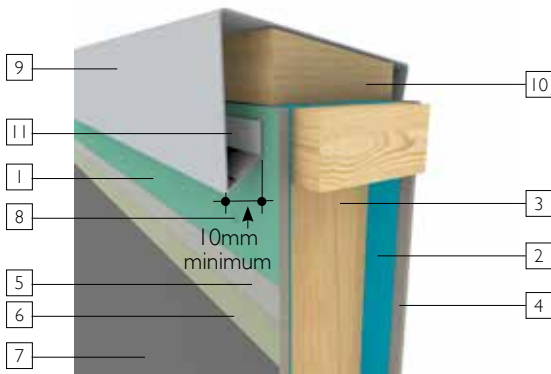
## Internal Corners



- |                               |                    |
|-------------------------------|--------------------|
| 1. Kalsi TextureBase          | 6. Texture coating |
| 2. Vapour permeable membrane  | 7. Top coating     |
| 3. Timber framing             | 8. Nail fixing     |
| 4. Polyurethane joint sealant | 9. Flashing        |
| 5. Skim coating               |                    |

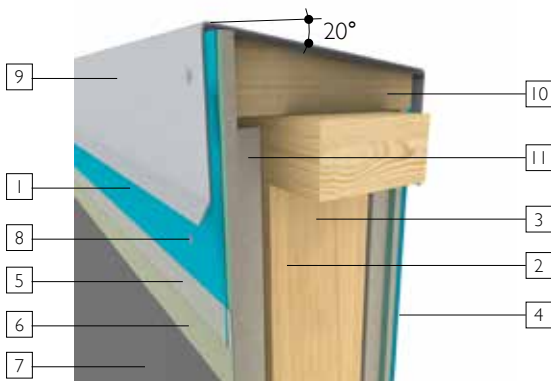
**Figure 30**  
Internal corners - drained cavity system

## Parapet Detail



- |                              |  |
|------------------------------|--|
| 1. Kalsi TextureBase         | 7. Top coating                               |
| 2. Vapour permeable membrane | 8. Nail fixing                               |
| 3. Timber framing            | 9. Pressed metal capping with sloped surface |
| 4. Internal parapet board    | 10. Packing                                  |
| 5. Skim coating              | 11. Parapet clips at 600 crs                 |
| 6. Texture coating           |  |

**Figure 31**  
Parapet details - direct fixed system

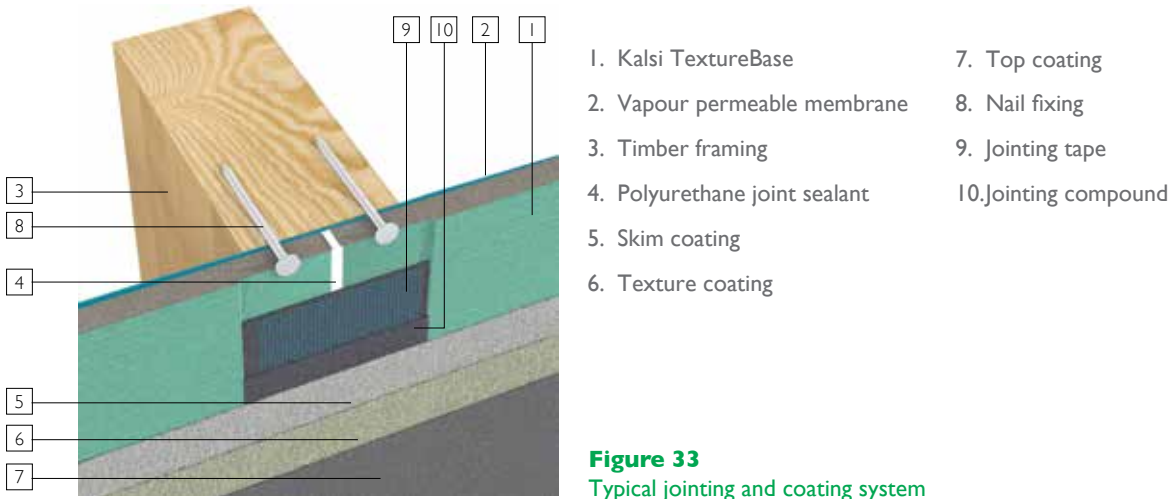


- |                              |  |
|------------------------------|--|
| 1. Kalsi TextureBase         | 7. Top coating                               |
| 2. Vapour permeable membrane | 8. Nail fixing                               |
| 3. Timber framing            | 9. Pressed metal capping with sloped surface |
| 4. Internal parapet board    | 10. Packing                                  |
| 5. Skim coating              | 11. Cavity batten                            |
| 6. Texture coating           |  |

**Figure 32**  
Parapet details - drained cavity system

# Finishing

Kalsi TextureBase flushed joint system provides a flat surface to which the textured coating/architectural finish can be applied to provide an attractive monolithic appearance. Figure 33 shows a typical arrangement of the jointing and coating system.



**Figure 33**  
Typical jointing and coating system

## Flush Jointing

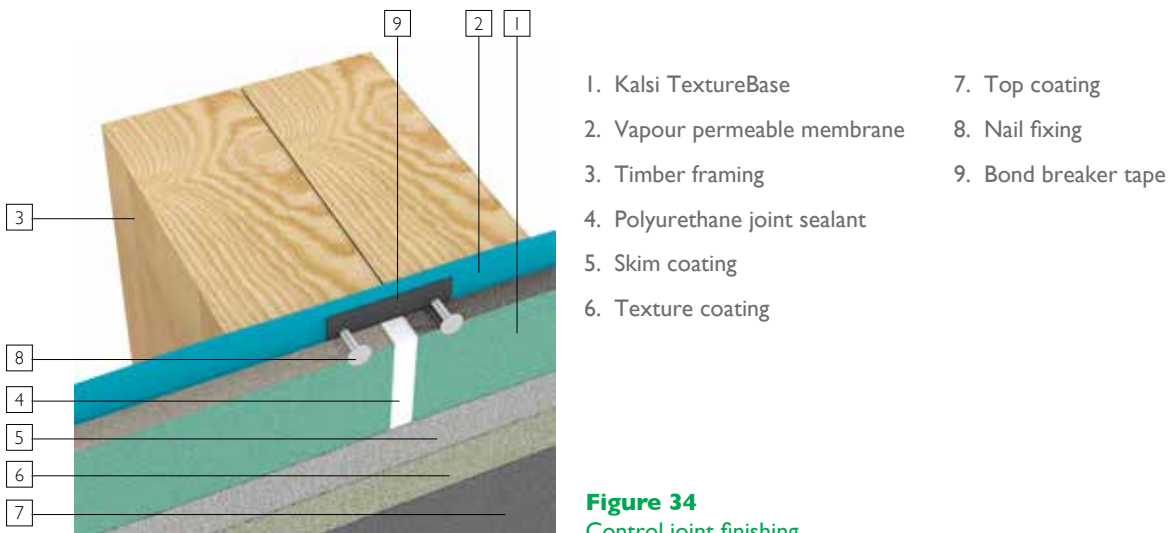
Two types of jointing compound can be used, acrylic jointing compound and cement-based stopping compound, depending on the installation requirements.

A typical procedure of flush jointing at board joint is outlined below:

- Apply a layer of joint compound into the joint.
- Press reinforcing fibreglass mesh or joint tape firmly into the joint compound.
- After the joint compound has dried, cover second layer with joint compound to fill the recessed area and level the joint.
- When dried, sand the joint areas using fine sand paper to give a smooth and flat joint surface.
- Apply additional coat if needed after prior application has dried.

When working on external corners of a building, jointing can be flush stopped by installing a PVC or corrosion resistance metal corner reinforcing angle corner bead vertically upwards and cover with joint stopping compound.

It is recommended that internal corners be sealed using exterior grade polyurethane joint sealants with bond breaking tape at the back of the joint. A similar application needs to be applied to movement control joint before applying texture coating. Refer to Figure 34.



**Figure 34**  
Control joint finishing



# Finishing

## Texture Coating

There is a wide variety of texture coatings available in the market, ranging from smooth polished surface to highly texture finished appearance, with or without random or regular patterns. Depending on the level of finish required, textured coatings can be applied using either spray, trowel or roller. Using a trowel may produce a heavy texture and spray technique may give a finer texture. Some manufacturers may recommend a skim coating before applying texture coating. This will level the whole surface and help provide a smoother final appearance.

Preparation and application of texture coatings may differ between manufacturers, as might their requirements. Be sure to obtain advice from the manufacturer or supplier for the performance and technical characteristics of specific texture coatings.

## Finishing Coat

Kalsi TextureBase boards need to be finished with a weatherproof coating to ensure durability and a long service life of the boards.

Be sure to obtain and understand the paint manufacturer's recommendations before commencing work.

Coating specifications available on request.



# Health & Safety

As for all products containing quartz (e.g. concrete and clay), Kalsi TextureBase when machined mechanically (cutting, sanding, drilling) will release dust which may contain quartz particles. Inhalation of high concentrations of dust may irritate the airways. Dust may also cause irritation of the eyes and/or skin. Inhalation of dust containing quartz, in particular the fine (respirable size) dust particulate matter, in high concentrations or over prolonged periods of time, can lead to lung disease (silicosis) and an increased risk of lung cancer.

- Avoid dust inhalation by using cutting equipment which features dust extraction or suppression accessories where practicable.
- Ensure adequate ventilation in the work place.
- Avoid contact with the eyes and skin and inhalation of dust by wearing appropriate personal protective equipment (safety goggles, protective clothing) and approved respirator, a dust mask of at least type P2.

For more information, consult the appropriate Product Data Sheet, available upon request.







**Kalsi TextureBase**

## Installation Guide

**Disclaimer:**

The sole purpose of images, references and recommendations in this document is to illustrate the functionality and versatility of the products and solutions from Kalsi and the proven international expertise of Etex Group. Note that the successful performance of the product & solutions depends on numerous factors outside Etex Building Performance Indonesia's control (quality of workmanship, design, handling and storage procedures, etc.)

**Promat Australia Pty Ltd**

1 Scotland Road, SA 5031 Mile End South

☎ 1800 Promat (776 628)

☎ +61 8 8352 1014

✉ [PAPL.mail@etexgroup.com](mailto:PAPL.mail@etexgroup.com)

[www.kalsi-building-solutions.com](http://www.kalsi-building-solutions.com)

